



MAGNUM CONTROLS

for Centrifugal Compressors

5580 Enterprise Pkwy.
Fort Myers, FL 33905

Office: 239-694-0089
Fax: 239-694-0031

www.mcscontrols.com



**MCS Total
Solution
for all your
Control
Needs**



**Energy Efficient and
RoHS Compliant**

The MCS Commitment is to provide practical solutions for the industries needs and to be both a leader and partner in the effective use of microprocessor controls.

Micro Control Systems, Inc.
5580 Enterprise Parkway
Fort Myers, Florida 33905
PH:(239) 694-0089 FAX:(239) 694-0031
www.mcscontrols.com

All information contained within this document is considered to be proprietary information of Micro Control Systems, Inc. No information or data from this document shall be published, used, reproduced, transmitted, or disclosed to others outside your organization without the prior expressed written consent of Micro Control Systems, Inc. This document and the information contained herein shall be treated as proprietary. Reasonable provisions shall be provided to ensure that this information remains proprietary by your employees, agents, and other personnel that may have access to this document.
Copyright ©2020

Table of Contents

Chapter - 1.	Introduction to the Magnum	9
Software		9
About the Magnum		9
Magnum V17 Software Control Point Capacity		9
Magnum Hardware Supported by Magnum V17 Software		9
Chapter - 2.	MCS-MAGNUM-N and Expansion Boards	10
2.1.	MCS-Magnum Revision 9.1	10
2.2.	MCS-SI16-A04- Version 1.3	12
2.3.	MCS-RO10 - Version 1.2	12
2.4.	MCS-Magnum-N-12 Revision 10.4	13
2.4.1	Optional Single Output Power Supply	13
2.5.	MCS-IO-BASE and MCS-IO-EXT	14
2.6.	MCS-RO-BASE and MCS-RO-EXT	17
2.7.	MCS-SI-BASE and MCS-SI-EXT	18
Chapter - 3.	Network Connection–MCS-485	19
3.1.	MCS 485 Network	19
Chapter - 4.	Network Connection–Ethernet	20
4.1.	RJ45 using a Crossover Ethernet Cable	20
Chapter - 5.	Network Connection–Remote	21
5.1.	Remote using Ethernet	21
Chapter - 6.	Centrifugal Compressor Control	22
6.1.	Centrifugal Related Terminology	22
6.1.1	Lift Pressure:	22
6.1.2	Variable Geometry Diffuser (VGD)	22
6.1.2.1.	Table Lookup for VGD Support	25
Chapter - 7.	Centrifugal Compressor Config Setup	28
7.1.	Centrifugal Base Compressor Setup MCS-Config	28
7.1.1	Modbus Fault Sensors	29
7.1.2	Typical Relay Output Setup	30
7.1.3	Compressor Speed Control	30
7.1.4	Compressor Vane Control	30
Chapter - 8.	Centrifugal Status Display	31
8.1.	MCS-Connect	31
Chapter - 9.	Authorization Function	33
Chapter - 10.	Magnum Displays	35
10.1.	Magnum keypad and display	35
10.1.1	Menu Screen	35
10.1.2	Introduction to Status Screens	35
10.1.3	Unit Status	35
10.1.4	Unit Tonnage and KW Information	35
10.1.5	Purge Status Screen (only if Purge cycles are active)	36
10.1.6	Compressor status	36
10.1.7	Compressor status (only CENT)	36
10.1.8	EXV status	36
Chapter - 11.	Magnum Control States	37
11.1.	UNIT IN POWER UP (0)	37
11.2.	NO RUN- I/O LOST (2)	37
11.3.	UNIT IN LOCKOUT (3)	37
11.4.	UNIT IS OFF (4)	37
11.5.	UNIT IS HOLDING (5)	37
11.6.	UNIT UNLDNG-VANE (6)	38
11.7.	UNIT IS LOADNG-VANE (7)	38
11.8.	OFF-SMOKE ALARM (8)	38
11.9.	RUN/STOP SW OFF (9)	38
11.10.	SCHEDULED OFF (10)	38
11.11.	OFF- NO FLOW (11)	38

11.12.	AMBIENT OFF (13)	38
11.13.	UNIT IS UNLOADED (15)	38
11.14.	UNIT IS LOADED (16)	38
11.15.	OFF TMP-ICE MADE (17)	38
11.16.	ECONOMIZER ONLY (18)	39
11.17.	SWITCHING MODES (19)	39
11.18.	VaneOpen-SpdHold (19)	39
11.19.	UNIT SMOKE UNLDG (20)	39
11.20.	UNIT OFF UNLDING (21)	39
11.21.	UNIT DMD UNLDING (22)	39
11.22.	UNIT HEAT UNLDING (23)	39
11.23.	UNIT UNLDNG-VFD (24)	39
11.24.	UNIT LOADNG-VFD (25)	39
11.25.	CMP SPD OPTIMIZE (33)	40
11.26.	UNIT IS OFF/TEMP (38)	40
Chapter - 12.	Compressor Control States (number)	41
12.1.	LOST IO LOCKED (0)	41
12.2.	CMP LOCKED OUT (1)	41
12.3.	SWITCHED OFF (2)	41
12.4.	UNLD and PMPDWN (3)	41
12.5.	CMP ANTICYCE (4)	41
12.6.	CMP OFF/READY (5)	41
12.7.	OIL PMP LUBING (6)	41
12.8.	NOT USED (7)	42
12.9.	CMP UNLOADED (8)	42
12.10.	CMP DECR SPEED (9)	42
12.11.	CMP INCR SPEED (10)	42
12.12.	CMP IS HOLDING (11)	42
12.13.	CMP OPEN VANES (12)	42
12.14.	CMP CLOSE VANES (13)	43
12.15.	CMP IS RUNNING (14)	43
12.16.	FAST UNLOADING (15)	43
12.17.	LO SUCT UNLOAD (16)	43
12.18.	LO SUCT HOLD (17)	43
12.19.	HI DISC UNLOAD (18)	43
12.20.	HI DISC HOLD (19)	43
12.21.	SAFETY TRIPPED (20)	44
12.22.	LO TMP UNLOAD (21)	44
12.23.	LO TMP HOLD (22)	44
12.24.	HI AMP HOLD (23)	44
12.25.	HI DIS TMP HLD (24)	44
12.26.	SURGE SPD/VANE (25)	44
12.27.	HI WATER HOLD (27)	44
12.28.	OFF-LO OIL TMP (29)	44
12.29.	HI AMP UNLDING (30)	44
Chapter - 13.	Lookup Tables	45
13.1.	Lookup tables used with MCS-MAGNUM controls	45
13.1.1	Setting up a Lookup table using MCS-CONFIG	45
13.1.2	Setting up Lookup table #1 - see screen 3 below:	46
13.1.3	Viewing the Lookup Table in MCS-Connect	47
13.1.3.1.	Using as Control Temperature Sensor	47
Chapter - 14.	Ice Making Capabilities	48
14.1.	HVAC/R unit using the cooling target reset	48
14.1.1	Target (SP #1) Reset Sensor	48
14.1.2	Reset Sensor Type 'Target Reset'	48
14.1.3	Reset Sensor Type 'Network Target Reset'	48
14.2.	Ice Making Mode	49
14.2.1	Terminating of ice making mode	49
14.3.	System as a pure ice making unit, Turbo Ice Machine	49
14.3.1	The # of Liquid Line Solenoids	49
14.3.2	Required set points for defrost cycles	50

14.4.	Turbo Ice Machine Operation	50
Chapter - 15.	Centrifugal Purge Setup and Operation	52
15.1.	External Purge System	52
15.1.1	External Purge System MCS-Magnum's Configuration Setup.....	52
15.1.2	External Purge System States.....	54
15.1.3	External Purge System Alarms	54
15.2.	Purge Carbon Tank Regeneration (Optional) - Rev 1.0.....	55
15.2.1	Carbon Tank Regeneration MCS-Magnum's Configuration Setup	55
15.2.1.1.	Relay Outputs Configuration:	55
15.2.1.2.	Sensor Input Configuration:.....	56
15.2.1.3.	Circuit Base setup	56
15.2.1.4.	Setpoint Configuration:.....	56
15.2.2	External Purge System Carbon Regeneration States	57
15.2.3	Carbon Tank Regeneration Alarms	57
15.2.4	Trane CVHE, CVHF and CVHG Earthwise Chillers.....	59
15.2.4.1.	MCS TRANE-CARBON PROBE SENSOR CONVERSION	59
Chapter - 16.	Standard Controls	60
16.1.	Custom Rotation.....	60
16.2.	Compressor Anti-Cycle Logic	60
16.3.	Part Wind and Star Delta Starters	61
16.4.	Full Load Amp (FLA) calculation and slide positioning	61
16.5.	Chiller Barrel Heater	62
16.6.	Hot Gas Bypass.....	62
16.7.	Chilled Water Reset.....	62
16.8.	Oil Equalization Option	62
16.9.	Liquid Injection Option.....	63
16.10.	Oil Cooler Option	63
16.11.	Oil Pump Control Option.....	63
16.12.	Oil Differential Calculation	64
16.13.	On/Off Switches.....	64
16.14.	Low Suction Unloading and Holding.....	64
16.15.	High Discharge Pressure Unloading and Holding	64
16.16.	High Discharge Temperature Unloading and Holding	65
16.17.	High Ampere Unloading and Holding	65
16.18.	Low Water Temperature Unloading and Holding	65
16.19.	Energy Efficient Compressor Staging.....	66
16.20.	Chilled Water Pump Control	66
16.20.1	Special Rotation for Chiller Pump Rotation	66
16.20.2	Special Rotation For Process Pumps Rotation.....	67
16.21.	Process Pump (Heat Exchanger) Control	67
16.22.	Control Power Relay (No Stop)	68
16.23.	Low and High Ambient Shutdown.....	68
16.24.	Imperial, Metric, and Combined Unit sensor readings.....	68
16.25.	Warning and Alarm Relay Outputs	68
16.26.	Vi Port Control Logic (Open Drive Screw only)	69
16.27.	Operating Schedules.....	69
16.28.	Mod-Motor Limit Control for Flooded Chiller.....	69
16.29.	Hot Gas Reheat (Humidity) Control.....	70
16.30.	Extra Liquid Line Solenoid Control	71
16.31.	Outside Air Economizer/Fluid Cooler with Analog	71
16.31.1	Output Control	71
16.31.2	Economizer Set up	71
16.31.3	Sequence of Operation.....	72
16.31.4	Outside Air Supply Economizer	73
16.31.5	Mechanical Cooling Enabled	73
16.31.6	Example: Fluid Cooler with VFD condenser fan	73
16.31.7	Example: Fluid Cooler with condenser compressor fans.....	74
16.32.	High Suction Superheat Safety	76
16.33.	Low Temperature Safety and Unload (Low Saturated Suction Temperature).....	76
Chapter - 17.	VFD Controlled Compressors	77

17.1.	INTRODUCTION	77
17.2.	STARTUP CONTROL	77
17.3.	OPERATING CONTROL	77
17.4.	COMPRESSOR LOADING / UNLOADING	77
17.5.	COMPRESSOR SHUTDOWN	77
17.6.	Staging	78
17.7.	VFD Interface - Hardwired	78
17.8.	VFD Setting	78
17.9.	CONFIG CONSIDERATIONS	78
Chapter - 18.	Centrifugal VFD Control Logic	80
18.1.	Control Logic – Surge Avoidance	80
18.2.	Control Logic – Surge Protection	80
18.3.	Surge and Stall Protection:	80
18.4.	Lift Based Surge Prevention Logic:	81
Chapter - 19.	Condenser Control Logic	82
19.1.	Condenser Introduction	84
19.1.1	RO Step Condenser Cut In – Out Logic	84
19.1.2	RO Step Condenser with Variable Speed Fan	85
19.1.3	Condenser Control	85
19.1.3.1.	Common Terms	85
19.1.3.2.	Control Discharge Pressure Calculation	85
19.1.3.3.	Condenser Reset	87
19.1.3.4.	Condenser Low Ambient	87
19.1.3.5.	Condenser Related Setpoints	88
19.2.	CONDENSER TYPES	88
19.2.1	No Condenser	88
19.2.2	RO Step Common	88
19.2.2.1.	RO Step Common with a Fan AO and Condenser Faults	89
19.2.3	RO Step Individual	90
19.2.4	RO Step Combined	91
19.2.5	Modulating	91
19.2.5.1.	Modulating Common	91
19.2.6	Modulating Step Common	93
19.2.6.1.	Modulating Individual	93
19.2.7	RO Shared	94
19.2.8	Dual V8	94
19.2.9	Common VFD Fan w/Bypass	94
19.2.10	Evaporative types of Condenser Control	96
19.2.11	RO Adaptive Bank– Air cooled Condenser Fan Control	97
19.2.12	RO Adaptive Common – Air Cooled Condenser Fan Control	98
19.2.12.1.	Adaptive Condenser Control Setpoints	98
19.2.12.2.	Adaptive Control Logic	99
19.2.12.3.	Adaptive Rotation Logic	99
19.2.12.4.	Viewing on MCS-CONNECT and MCS-MAGNUM LCD KEYPAD	99
19.2.13	PID MOD Individual	100
19.2.14	PID Step Common	101
19.3.	PID CONTROL	102
Chapter - 20.	Electronic Expansion Valve Control	103
20.1.	Electronic Expansion Valve Control Logic (EXV)	103
20.1.1	EXV Control States	107
20.1.2	EXV Maximum Operating Pressure	108
20.1.3	Tandem EXV Setup	108
20.1.4	Example: One Compressor with One Step and Tandem EXV's	108
20.1.4.1.	Example: Two Compressors with Four Steps and Tandem EXV's	109
20.1.5	'Evaporator or Condenser Refrigerant Level Control	109
20.1.5.1.	Minimum Refrigerant Level target (HVAC ONLY)	109
20.1.5.2.	Evaporator Level Control	110
20.1.5.3.	Condenser Level Control	110
20.1.6	EXV control methods for Step Loading Compressors	110

Chapter - 21. Sub Cooler EXV Control Logic	112
21.1. New Sensor Inputs	112
21.2. New Analog Outputs	112
21.3. Existing Relay Outputs	112
21.4. Calculated Values.....	112
21.5. New Config Parameters	113
21.6. Logic Requirements.....	113
Chapter - 22. EXV Control SSH, SSH2	115
22.1. Fast Suction Superheat (Fast SSH)	115
22.2. Fast Suction Superheat 2 (Fast SSH2)	115
22.3. Selecting Fast SSH or Fast SSH2 in MCS-Config	115
22.4. Circuit Base	116
22.4.1 Selecting the 'EXV Control' tab you are prompted with the following:	117
22.4.2 Selection Options.....	117
22.4.3 Compressor EXV Results	118
22.4.4 Subcooler EXV Results	118
22.4.5 MCS EXV Factory Default Set Point.....	119
22.4.5.1. Fast SSH2, Suction Superheat, Plate HX	119
22.4.5.2. Fast SSH2, Suction Superheat, DX Coil	119
22.4.5.3. Fast SSH, Suction Superheat, DX Barrel	119
22.4.5.4. Fast SSH2, Discharge Superheat, DX Barrel.....	119
22.4.5.5. Fast SSH, Suction Superheat, DX Barrel	120
22.4.5.6. Suct Spht, Suction Superheat, DX Barrel	120
22.5. Set Point Descriptions (Fast SSH & Fast SSH2).....	120
22.5.1 Set Point Adjustments.....	122
22.5.2 Low Suction Multiplier-SP 13	122
22.5.2.1. Low Superheat Adjustment-SP 15	122
22.5.2.2. EXV Startup Time-SP 20	122
22.5.2.3. EXV Compressor Start Delay-SP 20	122
22.5.2.4. EXV Target & EXV Fast Zone-SP 9	122
22.6. Fast SSH States	123
22.6.1 FAST SSH2 State Format.....	123
Chapter - 23. General Introduction to EXV PID	124
23.1. MCS PID REQUIREMENTS.....	124
23.2. Calculations for the adjustment to EXV valve.....	124
23.3. EXV PID Firmware	124
23.4. MCS PID REQUIREMENTS.....	125
23.5. Selecting PID in MCS-CONFIG.....	125
23.6. Circuit Base	125
23.7. Selecting the 'EXV Control' tab you are prompted with the following:	126
23.8. Selection Options	127
23.9. Compressor EXV Results.....	127
23.10. Set Point Descriptions (PID).....	128
23.11. PID Example Setpoint Defaults	129
23.11.1 Subcooler EXV Results	130
23.12. Logic to Determine which K Multipliers to Use	132
23.12.1.1. Switching to Fast K multipliers is based on:	132
23.12.1.2. Switching to Slow K multipliers is based on:	132
23.12.1 Rate of Change_- Moving too Fast.....	133
23.12.2 Rate of Change - Moving Slow Enough.....	133
23.13. MCS-Connect Evaporator EXV PID Status	134
23.14. Allowing an Adjustments to the EXV Valve.....	134
Chapter - 24. EXV Level Control using PID	135
24.1. Setting up EXV Level Control	135
24.1.1 Setting up EXV Level Control – User Defined	135
24.1.2 Circuit Base Setup	137
24.1.3 Setup using EXV CONTROL WIZARD	137
24.1.4 Low Discharge Superheat EXV Target Adjust Logic.....	138
24.1.4.1. The Low Discharge Superheat logic:.....	138

Chapter - 25. Analog Output Control using PID	140
Chapter - 26. BMS Communication Protocols	1
26.1. MCS-Magnum to BMS Connections	1
26.2. Sensor Input Points	2
26.3. Relay Output Points.....	3
26.4. Setpoints.....	4
26.5. Chiller/Compressor States.....	4
26.6. Other Points.....	5
26.7. Network inputs to MCS-Magnum.....	7
26.8. MCS Capacity Control State Chart.....	9
26.9. MCS Compressor Control State Chart	9
26.10. MCS-MAGNUM BMS PROTOCOLS.....	10
26.10.1 BACNET OVER IP PROTOCOL.....	10
26.10.2 ETHERNET NETWORK PROTOCOL	10
26.10.3 MODBUS RTU PROTOCOL.....	11
26.10.4 MODBUS TCP/IP PROTOCOL.....	11
26.11. PROTOCOLS USING MCS-BMS-GATEWAY	11
Chapter - 27. Network Protocols	12
27.1. Protocols MCS controllers support:.....	12
27.2. MCS-MAGNUM USING RS-485	13
27.3. MCS-MAGNUM USING ETHERNET	14
27.4. EXAMPLE NETWORK	15
27.4.1 Standalone MCS-Magnum	15
27.4.2 MULTIPLE MCS-MAGNUM Industrial Control Panels	16
27.5. MULTIPLE MCS-MAGNUM BMS RS485 WIRING DIAGRAM.....	17
Chapter - 28. MODBUS RTU	18
28.1. Setup the Modbus from MCS-Config's Magnum Setup Screen(see below):.....	18
28.2. From MCS-Connect's Service Window RS485 tab (see below):.....	19
28.3. From MCS-Magnum LCD/Keypad(see below):	19
28.4. In MCS-CONFIG you can see & print a list of the Modbus Registers (see below):.....	20
Chapter - 29. Magnum Alarms and Safeties	21
29.1. Information Only Alarms	21
29.1.1 System Generated Alarms	21
29.1.2 User Initiated Alarms.....	21
29.1.3 Automatic Alarms.....	22
29.2. Magnum System Alarms.....	22
29.2.1 Configuration Alarms	22
29.2.2 MCS Local Network Alarms	22
29.2.3 Key Sensors Alarms	22
29.2.4 Emergency Stop Alarm	23
29.3. Setpoint safety alarms	23
29.3.1 Sensor Inputs Used With Magnum Setpoint Safeties:.....	23
29.3.2 Setpoint safeties	23
Voltage Sensor (08.00-R)	25
Motor Amps (08.00-R)	25
Add an Amp Imbalance Safety Test to the existing Amp Safeties.(17.35)	25
29.4. TurboCor Compressor Alarms	25
Chapter - 30. Troubleshooting Quick Reference	28
Chapter - 31. Magnum Centrifugal Setpoints	30
31.1. Setpoint Types.....	30
31.1.1 SETPOINT.....	31
31.1.2 LOCKOUT.....	31
31.1.3 ALARM.....	31
31.1.4 Time	31
31.1.5 Target.....	31
31.1.6 Delay.....	31
31.2. Window/Safety extension	32
31.2.1 Time and seconds to ignore for setpoints	32
31.3. Revision Page	55

Chapter - 1. Introduction to the Magnum

Software

CENT V17—This software supports only centrifugal compressors, and requires a configuration type 119 CENT MAG CFG. If this software is loaded into a Magnum with a different type of configuration file, an invalid configuration type message will be generated.

About the Magnum

The Magnum controller is a microprocessor-based control system designed to provide complete control of many different types of compressors of both fixed and variable capacity, as well as many additional features. Supported control options include multiple liquid line solenoids, electronic expansion valves (EXVs), liquid injection, economizers, hot gas bypass, variable frequency drives for compressors (VFDs), digital scrolls, and many more.

Applications vary from control of a single compressor to complex multiple compressor systems.

In all applications, however, safety and operating efficiency is of primary importance.

The controller interface is made to be informative and meaningful, with built-in logic to prevent unsafe conditions from occurring. This helps reduce or even completely eliminate nuisance alarms.

Magnum V17 Software Control Point Capacity

- Circuits (compressors) up to 20
- Steps per Compressor up to 4
- Relay Outputs up to 80
- Analog Outputs up to 28
- Sensor Inputs up to 112
- Setpoints 255
- Alarms 100

Magnum Hardware Supported by Magnum V17 Software

The following MCS boards can be connected together through the MCS-I/O communications terminal block:

- MCS-Magnum (115/230 or 24vac) - 12 sensor inputs, 10 relay outputs, 4 analog outputs, 4 digital outputs
- MCS-RO10 (115/230 or 24vac) - 10 relay outputs
- MCS-SI16-AO4 (115/230 or 24vac) - 16 sensors and 4 analog outputs

Effective 3rd quarter 2019 (+12 system)

- MCS-Magnum-N-12 (12vac system) 12 sensor inputs, 10 relay outputs, 4 analog outputs, 4 digital outputs
- MCS-IO-BASE - 16 sensors, 4 analog outputs and 10 relay outputs
Add MCS-IO-EXT - 32 sensors total, 8 analog outputs total and 20 relay outputs total, same footprint
- MCS-RO-BASE - 10 relay outputs
Add MCS-RO-EXT - 20 relay outputs total, same footprint
- MCS-SI-BASE - 16 sensors, 4 analog outputs
Add MCS-SI-EXT - 32 sensors total, 8 analog outputs total, same footprint

The versatility of the Magnum offers the user much flexibility in configuring the controls in an economical way. The limitation is not the number of boards but the total number of set points.

Chapter - 2. MCS-MAGNUM-N and Expansion Boards

2.1. MCS-Magnum Revision 9.1



MCS-MAGNUM-N 115-230vac-Selectable Power

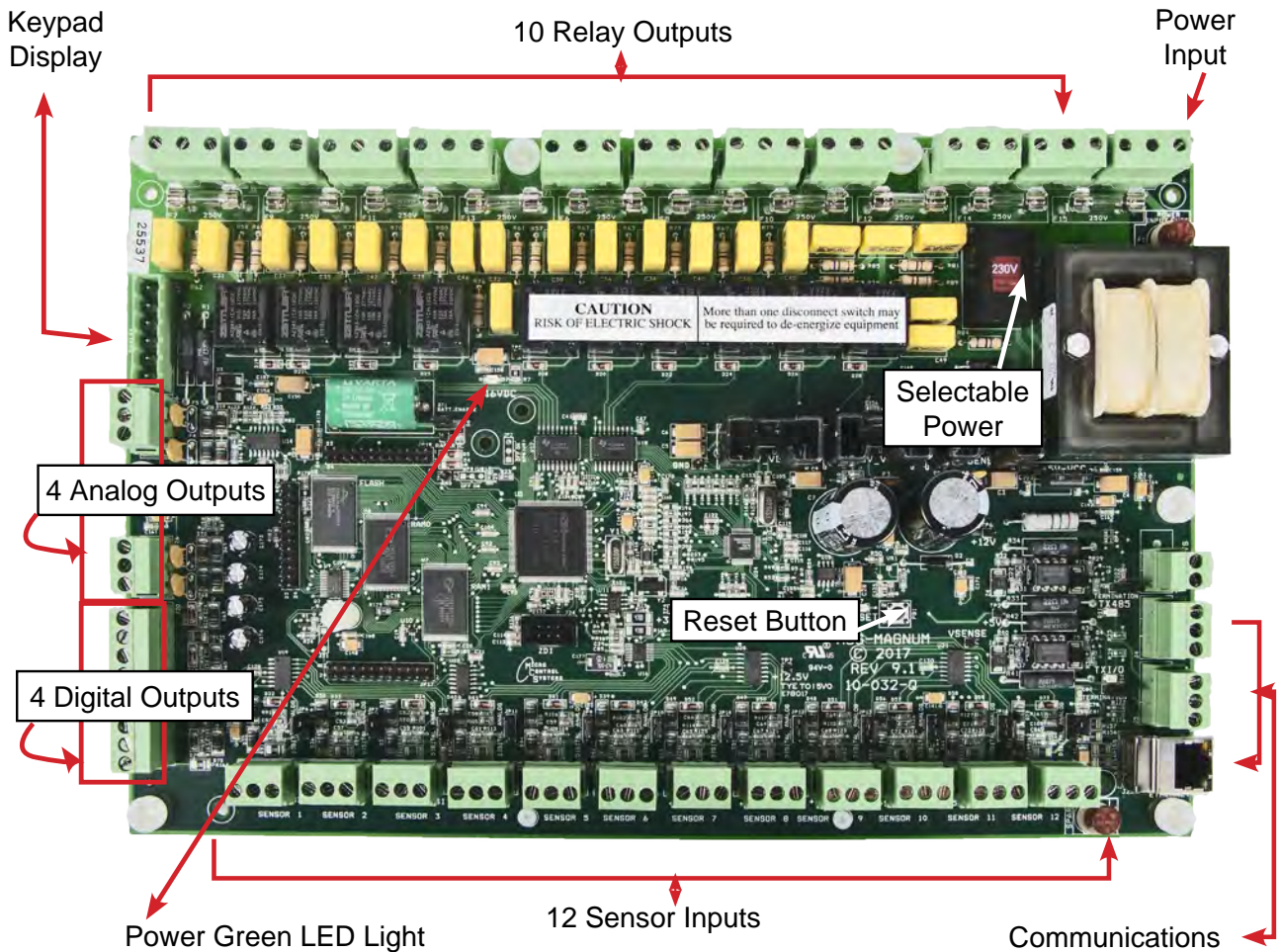

Controller Specifications

Dimensions..... 12.0" w, 8.0" h, 2.0" d
 Mounting Holes..... Mounts on a backplane using eight #6 sheet metal screws
 Operating Temperature..... -40°F to +176°F (-40°C to +80°C)
 Storage Temperature..... -40°F to +176°F (-40°C to +80°C)
 Microprocessor..... Zilog eZ80 Acclaim! @ 50mhz
 Sensor Inputs (SI)..... 12 inputs 0-5vdc (10-bit A/D)
 Digital Inputs..... 4 inputs 0 or 5vdc only
 Relay Outputs (RO)..... 10 outputs 6.3amps @ 230vac
 Analog Outputs (AO)..... 4 outputs 0-10vdc
 Printed Circuit Board..... Six layer with separate power and ground planes

Input Power (Standard)..... 115 or 230vac ±10% 50/60Hz @ 77°F (25°C) ambient, 20VA max (Voltage is field selectable)
 MCS-I/O Comm Port..... 1 @ 38,400 baud
 RS-485 Comm Port..... 1 @ 19,200 baud
 Ethernet..... 10/100 Mbps Ethernet
 Real Time Clock..... Battery backup
 Power Detection..... Automatic power fail reset

Options

-24 24vac input power ±10% 50/60Hz @ 77°F (25°C) ambient

MCS-MAGNUM HARDWARE

REV. 9.1

- ◆ MCS-MAGNUM hardware has been modified and its new revision number is - 9.1
- ◆ Hardware modification - Ethernet PHY chip was replaced due to obsolescent of the old Ethernet PHY chip by the manufacturer.
- ◆ **NEW ETHERNET PHY CHIP REQUIRES NEW FIRMWARE TO FUNCTION.**

FOLLOWING FIRMWARE VERSIONS (OR GREATER) ARE REQUIRED FOR MAGNUM HARDWARE VERSION 9.1

V7:

HVAC	07.03-V
CENT	07.03-V
REFR	07.03-V

V9:

HVAC	09.14-P
CENT	09.14-P
REFR	09.14-P
RTUM	09.14-P
PAO	09.14-P
ACU	09.14-P

V16:

HVAC	16.11-G
CENT	16.11-G
REFR	16.11-G
RTUM	16.11-G
PAO	16.11-G
ACU	16.11-G

V17:

HVAC	17.26-A or greater
CENT	17.26-A or greater
REFR	
RTUM	17.26-A or greater
PAO	17.26-A or greater
ACU	17.26-A or greater

2.2. MCS-SI16-A04- Version 1.3

The MCS-SI16-A04 provides a flexible and cost effective way to allow sensor input and analog output expansion for MCS MAGNUM and MicroMag controllers

Input Power (Standard) 115 or 230vac ±10% 50/60Hz
 Optional 24vac input power ±10% 50/60Hz

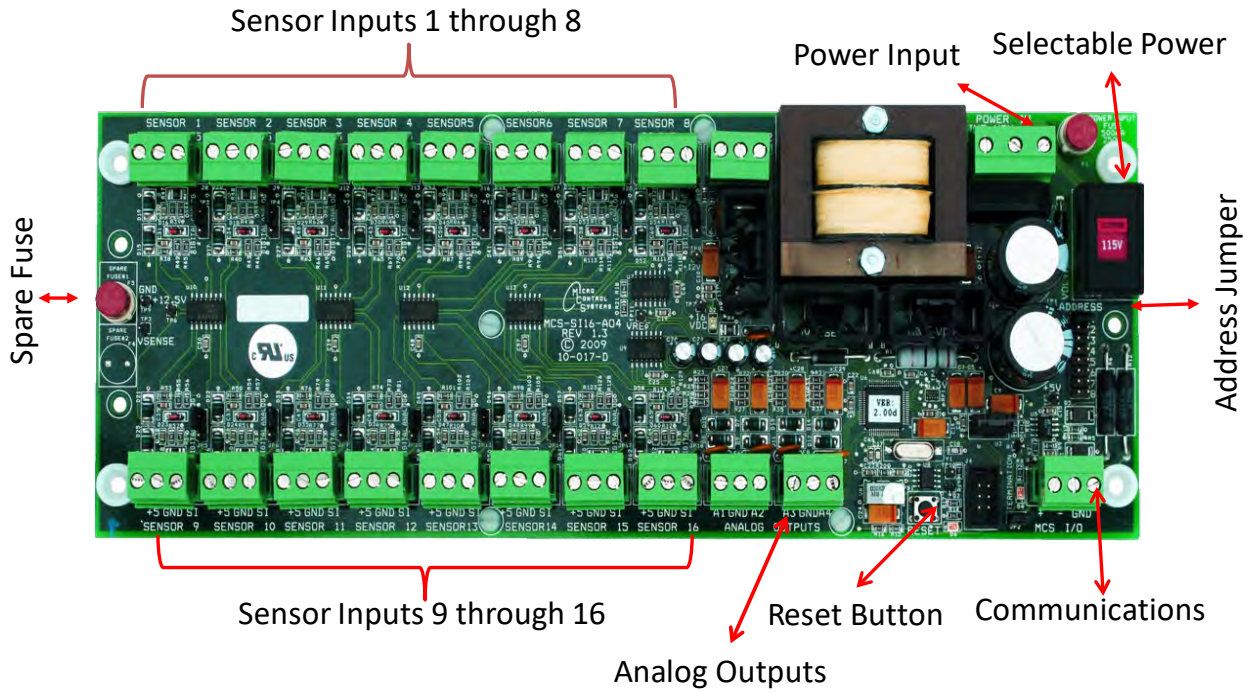

2.3. MCS-RO10 - Version 1.2

The MCS-RO10 provides a flexible and cost effective way to allow relay output expansion for MCS-MAGNUM and 1MicroMag controllers.

Input Power (Standard) 115 or 230vac ±10% 50/60Hz
 Optional 24vac input power ±10% 50/60Hz

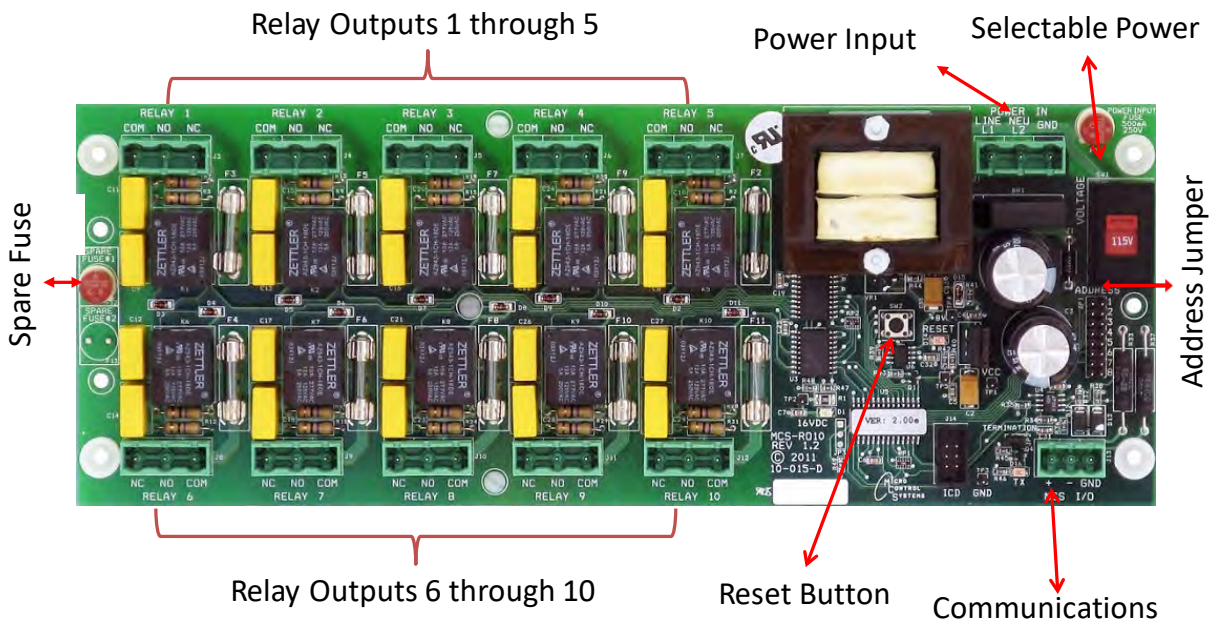

2.4. MCS-Magnum-N-12 Revision 10.4

Firmware Version required - see previous section

Input Power (Standard) +12vdc power in board from 95 - 265vac switching power supply

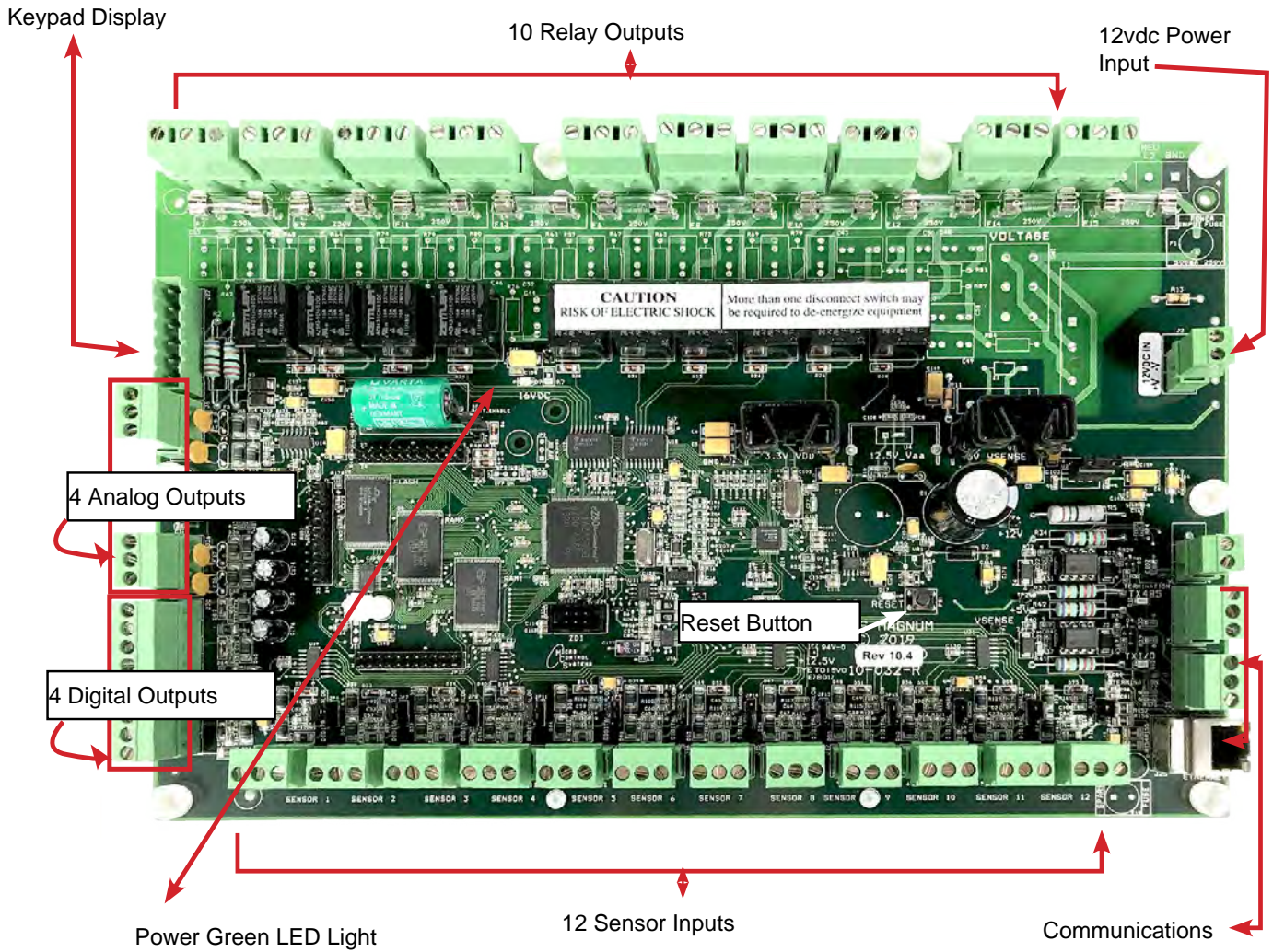

2.4.1 Optional Single Output Power Supply



100W Single Output Power Supply
Size: (L X W X H) (Inches):
6.3 x 3.8 x 1.5 inches
12Volts @ 8.5Amps

Power Supply is based on number of expansion boards that are being used in the system.

2.5. MCS-IO-BASE and MCS-IO-EXT

The MCS-IO-BASE provides a flexible and cost effective way to allow relay output, sensor input and analog output expansion for MCS MAGNUM-N-12.

Using a Single Output Power Supply the MCS-IO can be used with 115-230 or 24 volt MCS-MAGNUM-N or MicroMag systems.

Using the stackable MCS-IO-EXT you can double the number of inputs and outputs in the same footprint in your enclosure or mounted to a backplane.

Photo below shows MCS-IO-BASE and MCS-IO-EXT mounted in a stackable array.

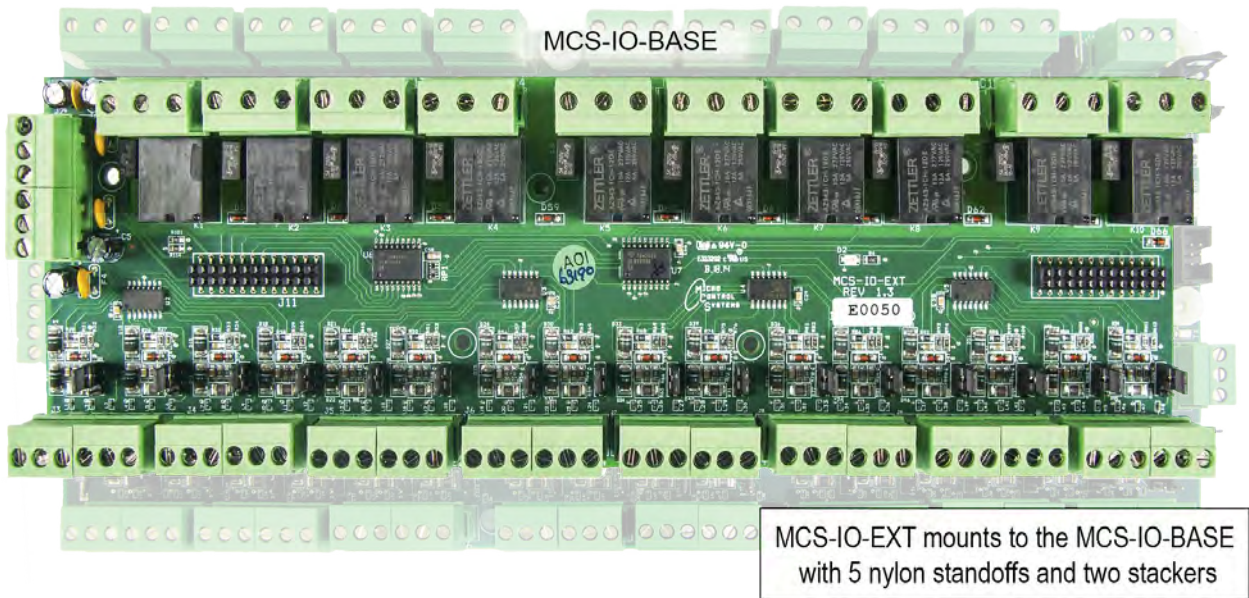

MCS-IO-BASE and MCS-IO-EXT

Dimensions	12.0"l, 5.5"w, 2.50"h
Mounting	Mounts on a backplane using six #6 sheet metal screws
Operating Temperature	-40°F to +158°F (-40°C to +70°C)
Operating Humidity	0-95% Non-Condensing
Storage Temperature	-40°F to +158°F (-40°C to +70°C)
Sensor Inputs	16 0-5vdc on base - 32 total with MCS-IO-EXT
Analog Outputs	4 outputs 0-10vdc on base - 8 total with MCS-IO-EXT
Relay Outputs	10 outputs 5amps @ 230VAC on base - 20 total with MCS-IO-EXT
Printed Circuit Board	Four layer with separate power and ground planes
Input Power (Standard)	12VDC Regulated power supply
MCS-I/O Comm Port	1 @ 38,400 Baud
Power Detection	Automatic Power Fail Reset

Theory for settings one MCS-IO-BASE plus extension boards

1. Address settings for installing MCS-IO-BASE and MCS-IO-EXT expansion boards:

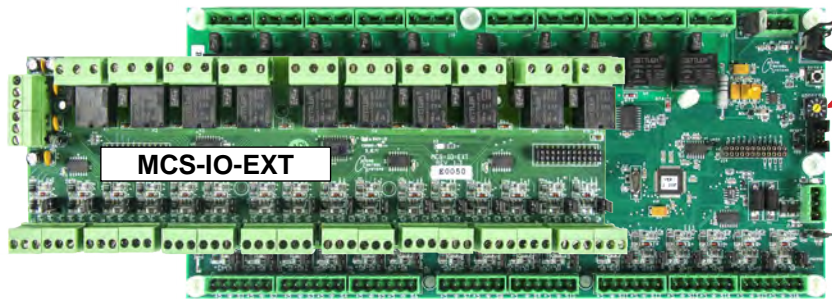

MCS-IO-Base - Set to #1
***Mount a MCS-IO-EXT
address automatically
is assigned #2***

2. Adding MCS-RO-BASE, MCS-RO-EXT

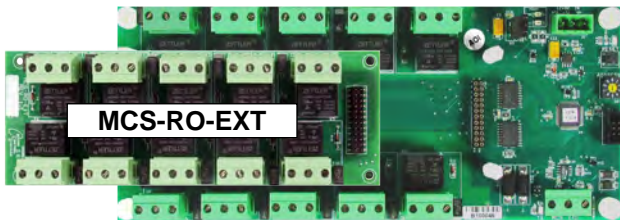

MCS-RO-Base - Set to #3
***Mount a MCS-RO-EXT
address automatically
is assigned #4***

3. Adding MCS-SI-BASE, MCS-SI-EXT

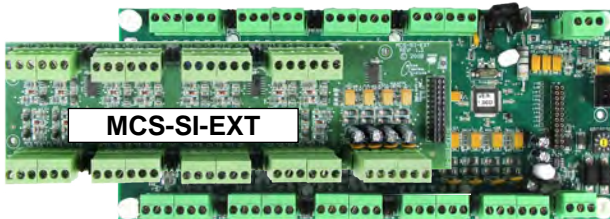

MCS-SI-Base - Set to #3
***Mount a MCS-SI-EXT
address automatically
is assigned #4***

SEE NEXT PAGE - ADDING A SECOND MCS-IO-BASE

Theory for settings two MCS-IO-BASE boards plus extension board

4. Address settings for installing MCS-IO-BASE and MCS-IO-EXT expansion boards:

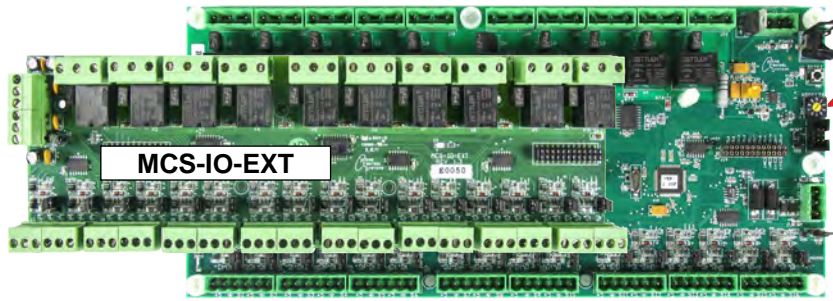

MCS-IO-BASE #1

MCS-IO-Base - Set to #1
***Mount a MCS-IO-EXT
address automatically
is assigned #2***

5. Adding second MCS-IO-BASE



MCS-IO-BASE #2

MCS-IO-Base - Set to #3

2.6. MCS-RO-BASE and MCS-RO-EXT

The MCS-RO-BASE provides a flexible and cost effective way to allow relay output expansion for MCS MAGNUM-N-12.

Using a Single Output Power Supply the MCS-RO can be used with 115-230 or 24 volt MCS-MAGNUM-N or MicroMag systems.

Using the stackable MCS-RO-EXT you can double the number of inputs and outputs in the same footprint in your enclosure or mounted to a backplane.

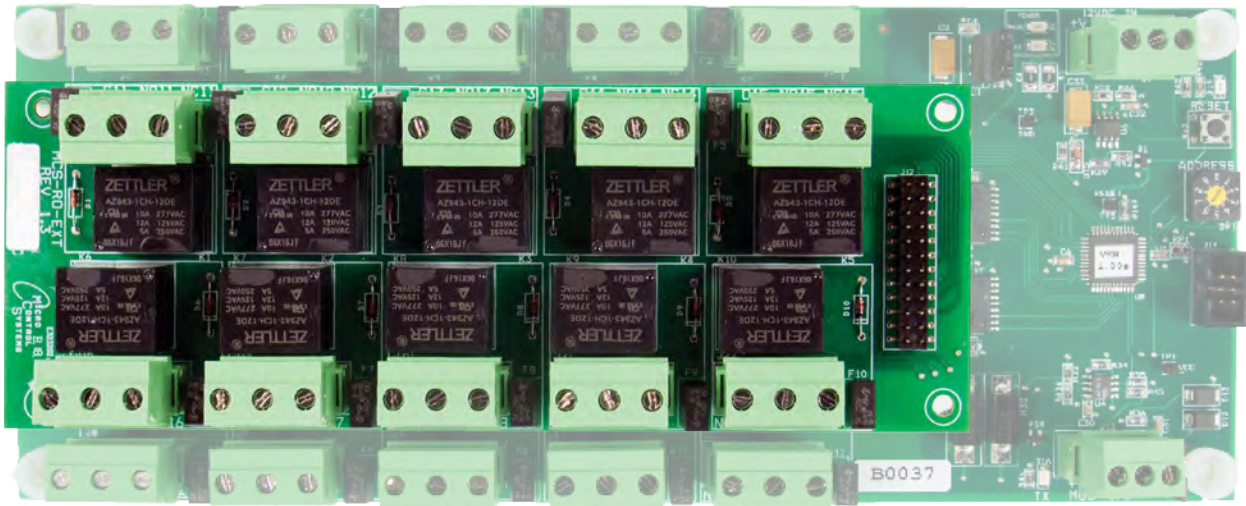

MCS-RO-BASE and MCS-RO-EXT

Dimensions	9.5"l, 4.00"w, 2.50"h
MCS-RO-BASE	Mounts on a backplane using four #6 sheet metal screws
MCS-RO-EXT	Mounts on top of the MCS-RO-BASE by 4 nylon standoffs and a stacker header (included on MCS-RO-BASE)
Operating Temperature	-40°F to +158°F (-40°C to +70°C)
Operating Humidit	0-95% Non-Condensing
Storage Temperature	-40°F to +158°F (-40°C to +70°C)
Microprocessor	Microchip PIC16F883 @ 8mhz
Relay Outputs (RO)	10 outputs 5amps @ 230VAC on bsse - 20 total with MCS-RO-EXT
Printed Circuit Board	Four layer with separate power and ground planes
Input Power (Standard	12VDC input power ±10% @ 77°F (25°C) ambient, 12VA max
MCS-I/O Comm Port	1 @ 38,400 Baud
Power Detection	Automatic power fail reset

2.7. MCS-SI-BASE and MCS-SI-EXT

The MCS-SI-BASE provides a flexible and cost effective way to allow sensor input expansion for MCS MAGNUM-N-12.

Using a Single Output Power Supply the MCS-SI can be used with 115-230 or 24 volt MCS-MAGNUM-N or MicroMag systems.

Using the stackable MCS-SI-EXT you can double the number of inputs and outputs in the same footprint in your enclosure or mounted to a backplane.

MCS-SI-BASE and MCS-SI-EXT

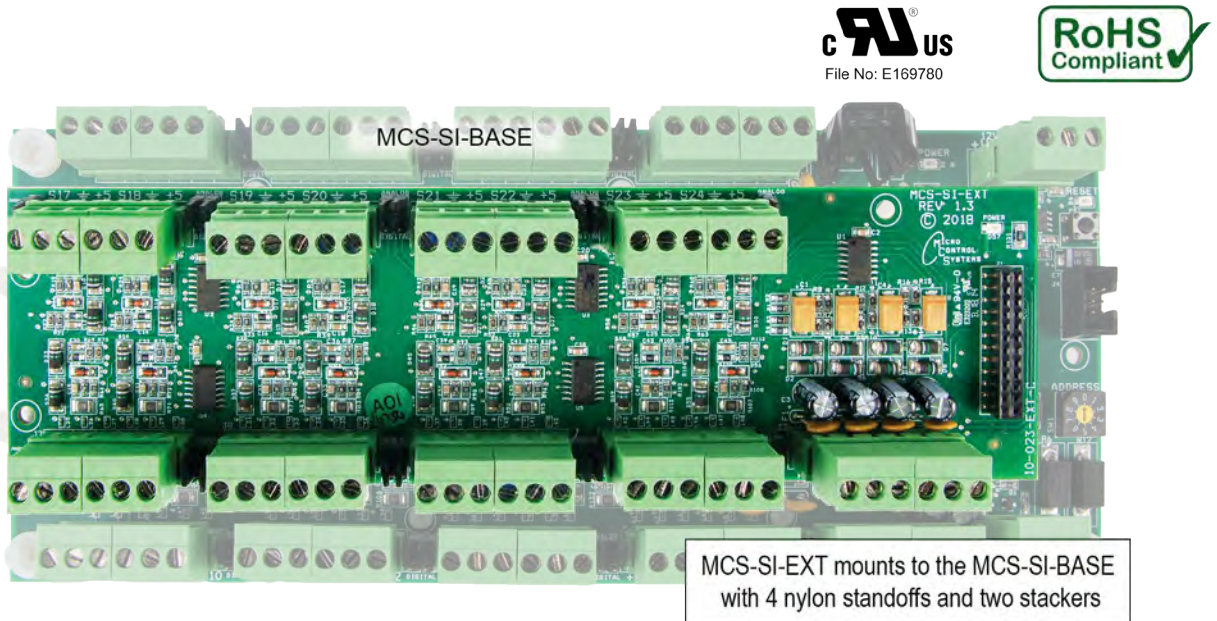

Dimensions	8.7"l, x 2.50"w, x 2.50"h
MCS-SI-BASE	Mounts on a backplane using four #6 sheet metal screws
MCS-SI-EXT	Mounts on top of the MCS-SI-BASE by 4 nylon standoffs and stacker headers (included on MCS-SI-BASE)
Operating Temperature	-40°F to +158°F (-40°C to +70°C)
Operating Humidity	0-95% Non-Condensing
Storage Temperature	-40°F to +158°F (-40°C to +70°C)
Sensor Inputs	16 inputs 0-5vdc on base - 32 total with MCS-SI-EXT
Analog Outputs	8 outputs 0-10vdc on base - 16 total with MCS-SI-EXT
Printed Circuit Board	Four layer with separate power and ground planes
Input Power	Powered by MCS-SI-BASE Power
Power Detection	Automatic Power Fail - Reset on MCS-SI-BASE

Chapter - 3. Network Connection-MCS-485

The next few pages show recommended network setups for communication to your controller using products from MCS.

3.1. MCS 485 Network

The MCS 485 Network can support up to 20 Magnums and their associated I/O boards. Access to this network can be remotely through a 14.4K Baud modem. When using the dialup connection through a modem there is no degradation in the performance of the network.

Each Magnum in the network must be assigned a unique address in the configuration file. This address will be the key in establishing communications with the appropriate Magnum system. It can be viewed or changed from the LCD / key-pad of the unit with Factory authorization.

RS485 transmissions should not exceed 1 mile without a repeater.

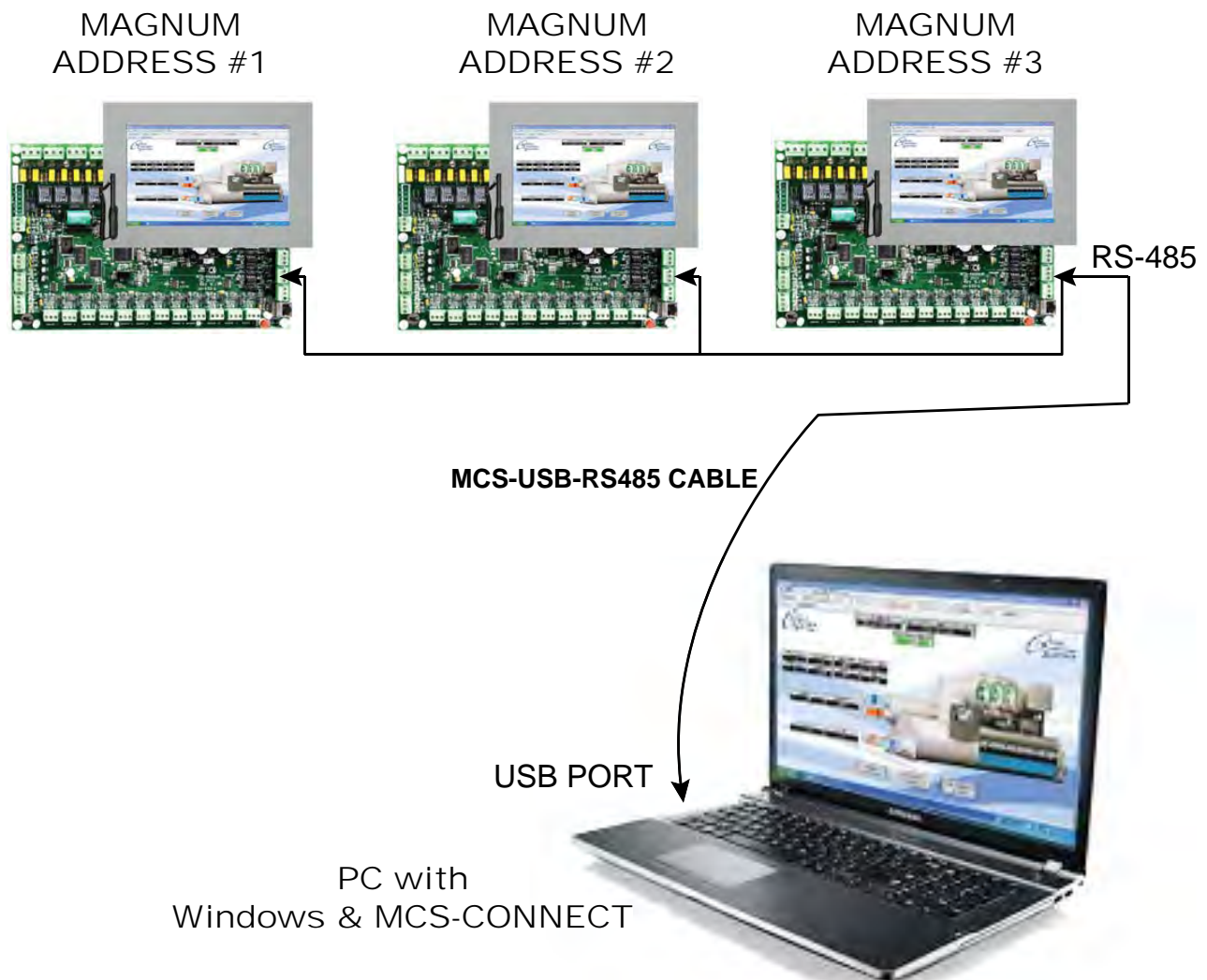

Chapter - 4. Network Connection-Ethernet

4.1. RJ45 using a Crossover Ethernet Cable

When connecting directly through the 10 MBPS Ethernet port on the Magnum from a PC it is necessary to use a crossover Ethernet cable.

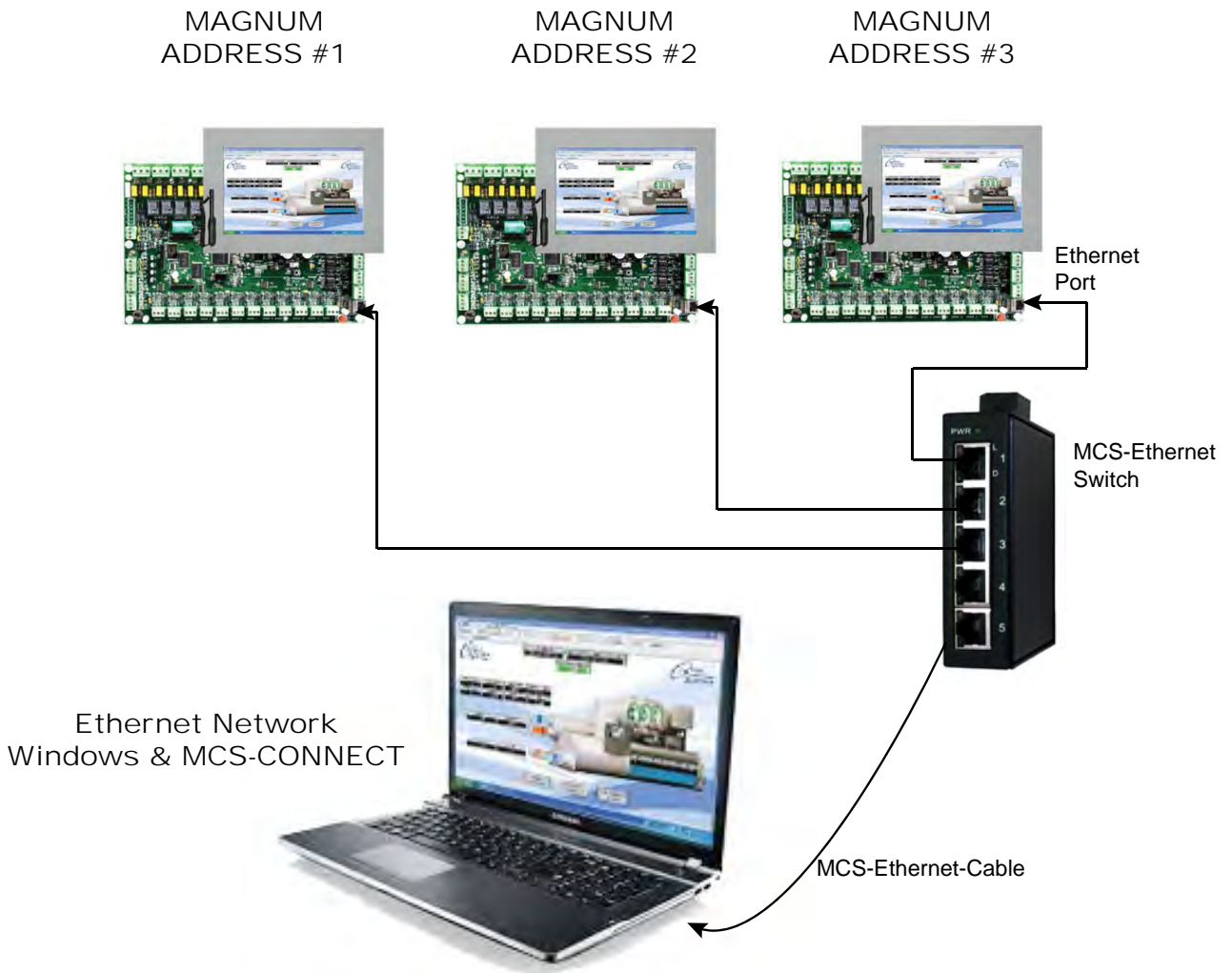

Chapter - 5. Network Connection-Remote

5.1. Remote using Ethernet

When connecting directly through the 10 MBPS Ethernet port on the Magnum from a PC it is necessary to use a crossover Ethernet cable to the MCS-WIRELESS MODEM.

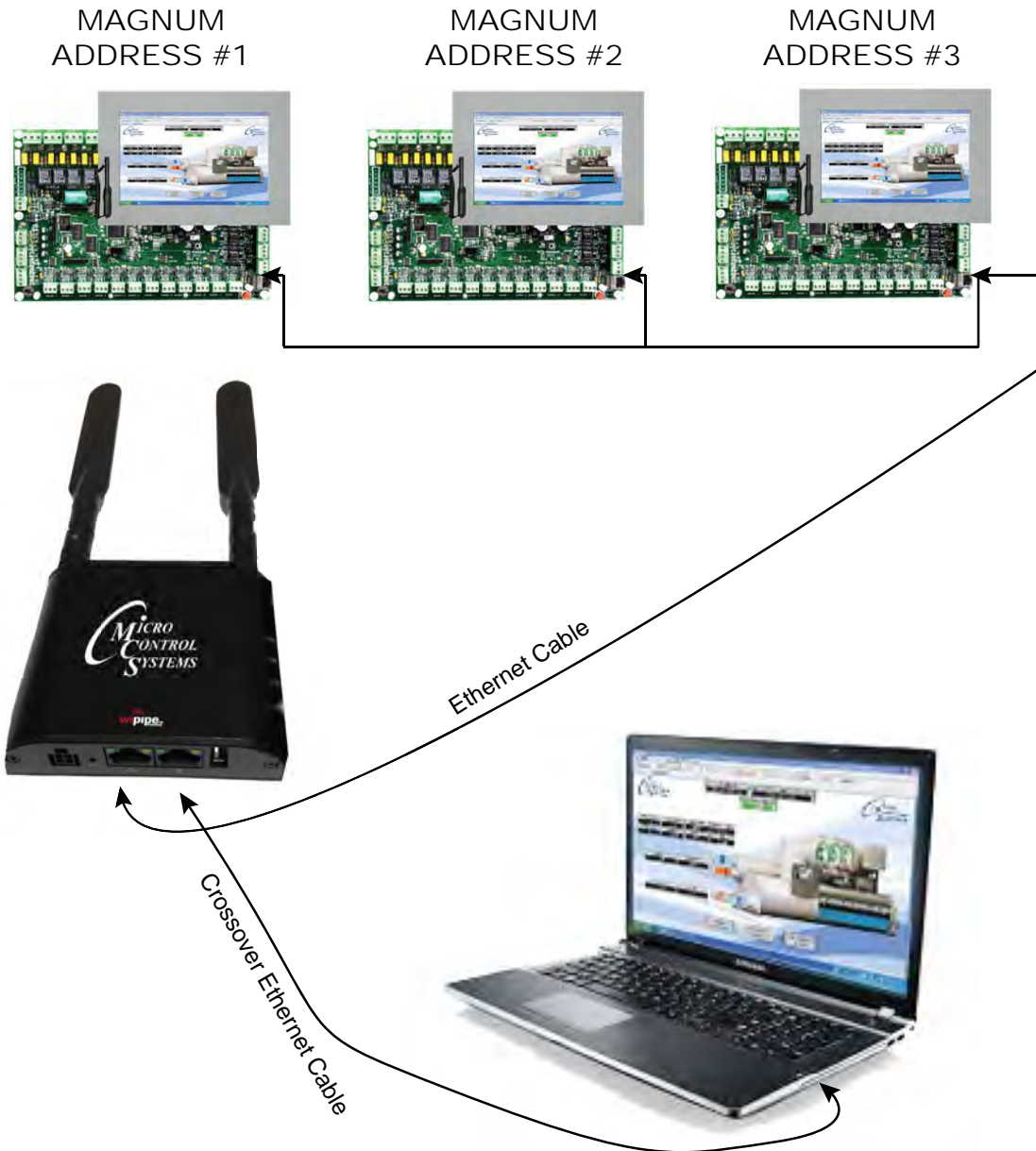

See Label for Actual Setting

MCS-WIRELESS MODEM is shipped from the factory with the IP address configured for you. Instructions on how to setup your PC to communicate with the MCS-WIRELESS MODEM will be included.

Chapter - 6. Centrifugal Compressor Control

There are many differences, in both concept and function, between centrifugal compressors and other types. For certain applications, centrifugal compressors have distinct advantages such as high energy efficiency, high volume of airflow, and low maintenance due to the small number of moving parts. When combined with a Variable Frequency Drive (VFD) it becomes simple and efficient to vary the speed of the compressor and operate at part load.

To provide control for this unique type of compressor MCS has developed a new type software specific to centrifugal units: CENT V17. Much of the control logic is similar to that found in HVAC V17. A target value and control zone are calculated, and then compressor capacity is modulated to keep the control sensor within that zone. Input sensors are monitored constantly and preventative action is taken to protect the unit from any potentially unsafe or damaging conditions. Different from other types of units though, both compressor speed and vane position must be taken into consideration since both affect cooling capacity.

6.1. Centrifugal Related Terminology

The following terms relate to the control of centrifugal compressors and how CENT V17 processes them.

6.1.1 Lift Pressure:

Lift pressure equals condenser pressure minus evaporator pressure. The lower the lift pressure is, the more efficiently the system operates.

6.1.2 Variable Geometry Diffuser (VGD)

The VGD is a system for preventing stall in a centrifugal compressor.

Purpose of Change

The purpose of this change is to add a control logic Variable Geometry Diffuser used on Centrifugal compressors. This change is only required in the MCS-Magnum Centrifugal firmware.

Existing Sensor Inputs

Vane % – Analog sensor input which indicates the inlet guide vane position. Typically it is a high precision potentiometer.

This sensor was optional on non-Variable Frequency Drive centrifugal. It is now required for both VFD application and VGD applications.

New Sensor Inputs

VGD % – Analog sensor input which indicates the Variable Geometry Diffuser position. Typically it is a high precision potentiometer.

New Relay Outputs

Open VGD – relay output used to open the Variable Geometry Diffuser. This relay will need to be pulsed ON to move the VGD a little bit at time. Pulsing logic is similar to the vane control and/or slide on screw compressor.

Close VGD – relay output used to close the Variable Geometry Diffuser. This relay will need to be pulsed ON to move the VGD a little bit at time. Pulsing logic is similar to the vane control and/or slide on screw compressor

New Configurable Values

VGD Wanted % Lookup Table – The values in the first column of the look up table will be inlet guide vane % and second column values will be the wanted Variable Geometry Diffuser position. Below is an example of the lookup table with 11 entries (need to allow for up to 15 entries/rows):

IGV%	Wanted VGD%
0	0
10	5
20	16
30	28

40	45
50	60
60	70
70	70
80	70
90	72
100	75

New setpoints required to control the VGD:

1. VGD% Target – this setpoint will be calculated based on the current Vane% and lookup table.
2. VGD% deadband – this setpoint will define the deadband around the wanted VGD% target. If the current position of the VGD% is within this deadband, the VGD will not be moved.
3. VGD% delay – this is the time delay between pulsing the VGD open or closed.
4. VGD% pulse – this is the time to pulse ON the open and closed VGD relays to move the VGD. Time delay is in tenths of second. Same the vane/slide pulse timing setpoints.
5. VGD NOT MOVING – contains the number of pulses without any movement in VGD to generator an alarm. If the setpoint type is an alarm then simple generate alarm message and keep on controlling the VGD. If the setpoint type is a lockout, then lockout the VGD and no longer control it.
6. Others?

Logic Requirements

1. VGD control logic needs to run 1 second.
2. Suggest we create new state for VGD logic:
 - a. VGD is LOCKEDOUT
 - b. CMP OFF-VGD CLOSED
 - c. VGD% HOLDING
 - d. VGD% OPENING
 - e. VGD% CLOSING
 - f. Others?
3. If the compressor is off:
 - a. The wanted VGD% is force to 0.0%
 - b. The closed VGD relay output is turned on for 10 mins to force the VGD fully closed. After 10 mins the closed relay is turned off.
 - c. The VGD open relay is turned off.
 - d. The time delay between VGD relay on pulse is set to zero. This will allow a pulse (if required) once the compressor starts.
 - e. This is the CMP OFF-VGD CLOSED state.
4. Once the compressor is running:
 - a. When the compressor is started the VGD state is moved from CMP OFF-VGD CLOSED to VGD% HOLDING.
 - b. The time delay needs to be decrement once every second until it reaches zero. Once it reaches zero, if a VGD needs to be moved (current VGD% is outside the Wanted VGD% plus/minus the VGD% deadband) then the open or closed relay is pulsed and the time delay reset to the value in VGD% delay setpoint. Only when an ON pulse is given is the time delay reset. If no pulse is required the time delay is left at zero to allow a pulse once it is required.

c. The inlet guide vane % and VGD Wanted% lookup table is used to determine the wanted VGD%. The logic needs to search thru the look up table's IGV% column and find the two rows the current Vane% falls within. Then the logic needs to use these two rows (IGV% and Wanted VGD%) entries to calculate the Wanted VGD% target using linear line equation. The two row entries define the linear line. For example use the above lookup table and if the current Vane% is 25.0%, then the two rows that the Vane% falls with are (20%, 16%) and (30%, 28%). Then the linear line is:

And the Wanted VGD% is 22%. This value should be temporarily written in the VGD% Target setpoint.

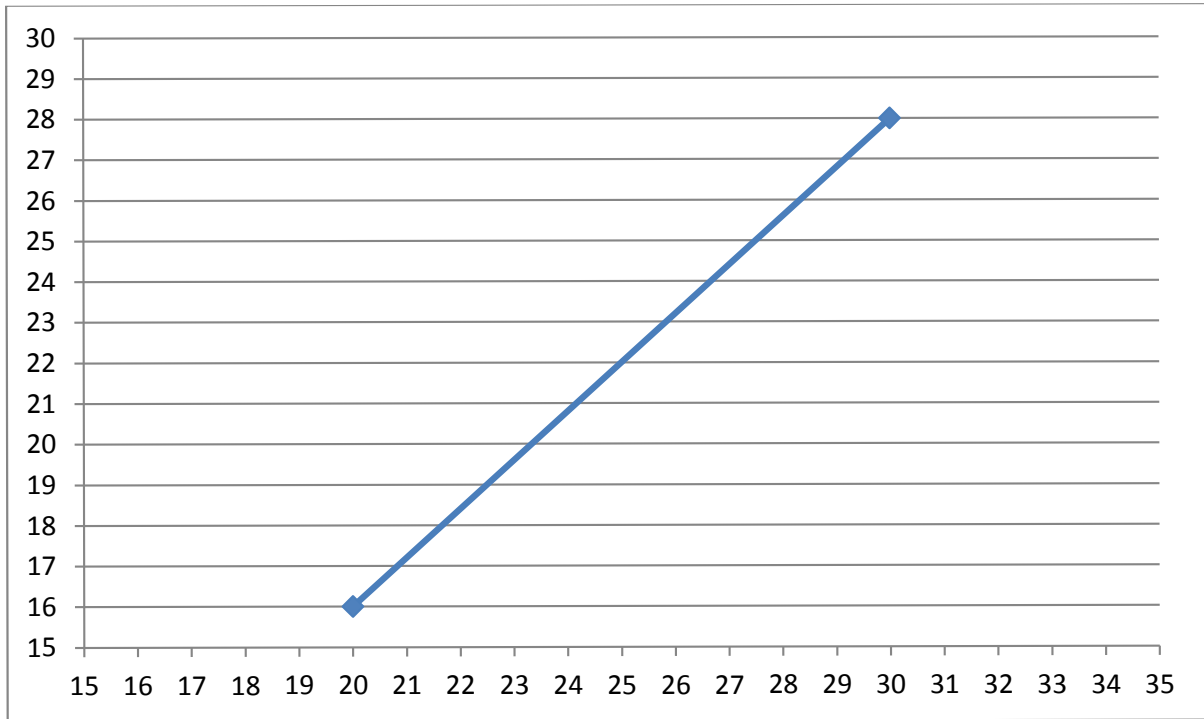

- d. If the current VGD% is below the Wanted VGD% minus the VGD deadband setpoint, then the VGD state need to move to VGD% OPENING and the VGD open relay needs to be pulsed ON until the VGD% falls within the deadband. An ON pulse is only allowed when the time delay is zero. Once a pulse is given the time delay is reset to the VGD time delay setpoint value. The VGD closed relay needs to be turned off.
- e. If the current VGD% is above the Wanted VGD% plus the VGD deadband setpoint, then the VGD state needs to move to VGD% CLOSING and the VGD closed relay needs to be pulsed ON until the VGD falls within the deadband. An ON pulse is only allowed when the time delay is zero. Once a pulse is given the time delay is reset to the VGD time delay setpoint value. The VFD open relay needs to be turned off.
- f. If the VGD% is not moving (used the deadband setpoint value as minimum movement amount) after 60 pulses, generate warning alarm "VGD NOT MOVING". IF the setpoint is setup as alarm type keep controlling the VGD. If the setpoint is set as a lockout then lockout the VGD relays and stop controlling the VGD and set the state to VGD is LOCKEDOUT. When moving from the holding state to either open or closing the VGD, store the current VGD position. If x pulses the VGD% has not moved more than the amount define in VGD% setpoint, the VGD is not moving. If VGD is moving, every time it moves the deadband amount update the stored VGD%. This is similar to screw compressor slide loading and unloading logic used to determine the slide is fully closed or open.

5. Need to view the VGD state, Wanted VGD%, VGD Time delay on MCS-Magnum LCD display and on MCS-Connect control state window.

6.1.2.1. Table Lookup for VGD Support

Provides additional capability in specifying the VGD surge table.

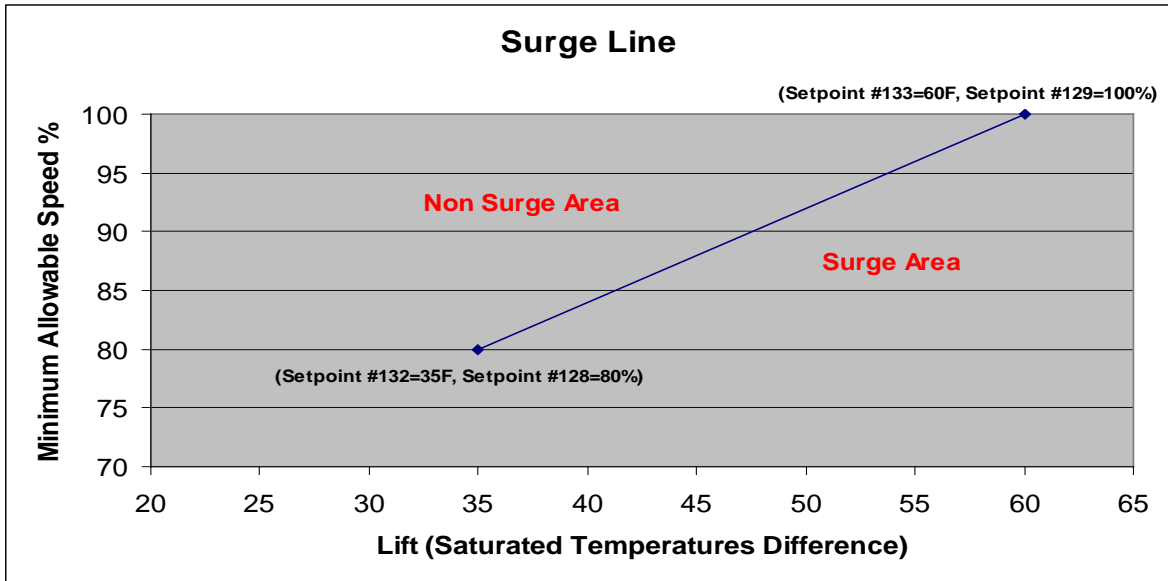

Purpose of Change

The purpose of this change is to add a second option to calculate the minimum allowable speed on variable speed centrifugal application to prevent a surge condition (MCS-Magnum centrifugal firmware only). The current min allowable speed logic uses a linear line calculation to determine the minimum allowable speed (see Surge Line Chart below).

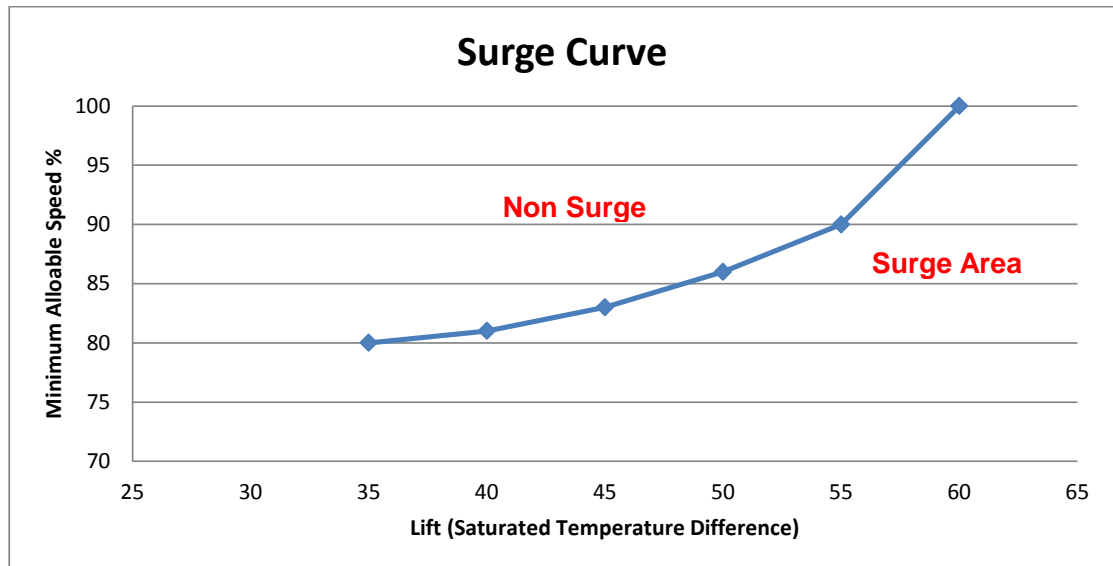

The new logic will allow for a curved line (using a lookup table) to better optimize the energy efficiency of the centrifugal compressor while still running the compressor in non-surge condition (See Surge Curve Chart below).

Existing Sensor Inputs

Suction Pressure – Analog sensor used to read the suction pressure – before the inlet guide vanes.

Turbine Inlet Pressure – Analog sensor used to read the suction pressure after the inlet guide vanes. (This sensor is optional – if not installed suction pressure is used in its place)

Discharge Pressure – Analog sensor used to read the discharge pressure

Existing Calculated Input Values

Saturated Suction Temperature – Suction pressure converts to saturated temperature based on the refrigerant type and Pressure to Temperature chart.

Saturated Turbine Temperature – Turbine pressure converts to saturated temperature based on the refrigerant type and Pressure to Temperature chart.

Saturated Discharge Temperature – Discharge pressure converts to saturated temperature based on the refrigerant type and Pressure to Temperature chart.

Saturated Lift Temperature – Saturated Discharge Temperature minus Saturated Turbine Temperature (Saturated Suction temperature if Turbine Inlet pressure sensor is not used).

Existing Calculated Setpoints

Minimum Allowable Speed – this is the minimum speed the compressor is allowed to run at to avoid causing any surges. This calculated value is temporarily stored in setpoint #128 “CmpMinSpeed%”, but not permanently saved to the MCS-Magnum configuration. This will allow the user to see the calculated min allowable speed the logic is currently using.

New Configurable Values

Option to use Minimum Allowable Speed Lookup Table – need an option to select using a lookup table in place of the existing linear surge line calculation logic. This option needs to default to the existing linear surge line calculation in existing MCS-Magnum configurations. This will allow for the MCS-Magnum firmware to be upgraded without having to add the lookup table into the configuration.

Min Allowable Speed Lookup table –The values in the first column of the look up table will be saturated lift temperatures and second column values will be the minimum allowable speeds. Below is an example of the lookup table with 6 entries (need to allow for up to 10 entries/rows):

Saturated Lift Difference (F)	Minimum Allowable Speed (%)
35	80
40	81
45	83
50	86
55	90
60	100

This table needs to be stored in the configuration of the MCS-Magnum. MCS-Config needs to allow the user to define the total number of entries (rows) and enter the values. It would be nice to be able to change this table in MCS-Connect, but it is not required.

Logic Requirements

The MCS-Magnum existing minimum allowed speed logic needs to be modified to add a second option.

If configured not to use the minimum allowable speed logic, the existing linear surge calculated value will be used. No change to the current logic.

If configured to use the surge lookup table the minimum allowable speed calculation logic will take the calculated lift and use it to find the minimum allowable speed. The logic needs to search thru the look up table's Saturated Lift column and find the two rows the current lift falls within. Then the logic needs to use these two rows (lift and speed) entries to calculate the min allowable speed using linear line equation. The two row entries define the linear line. For example use the above lookup table and if the current lift is 42.5F, then the two rows that the lift falls with are (40F, 81%) and (45F, 83%). Then the linear line is:

And the calculated minimum allowable speed is 82.0%.

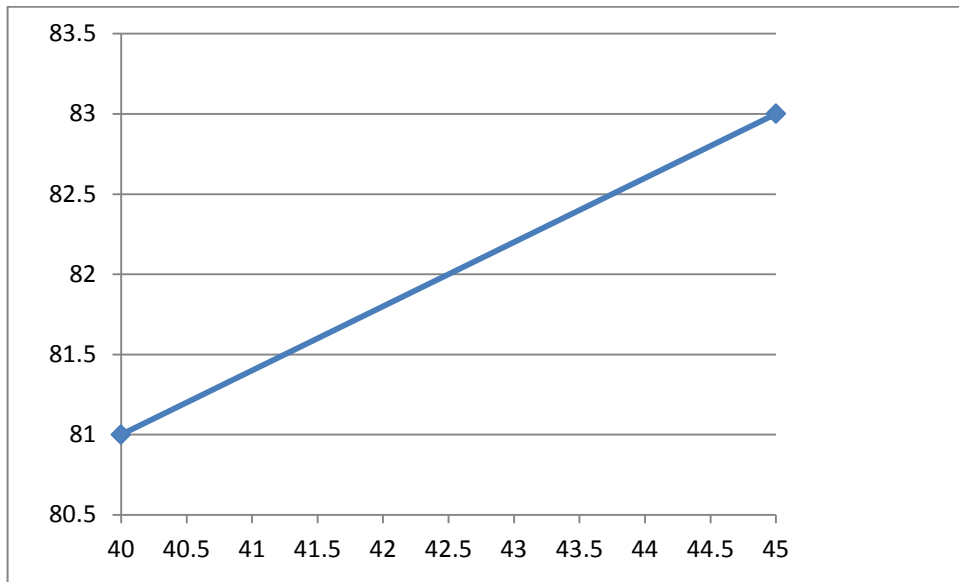

Once the minimum allowable speed value is calculated it needs to be temporarily stored in setpoint #128 "CmpMinSpeed%". The centrifugal VFD logic uses setpoint #128 value as the minimum allowable speed.

Chapter - 7. Centrifugal Compressor Config Setup

7.1. Centrifugal Base Compressor Setup MCS-Config

Similar to the HVAC software the header buttons for this type of configuration file are as follows:

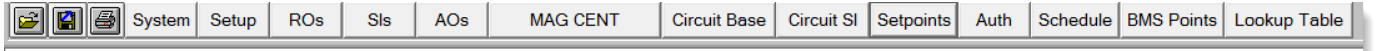

In the MAG CENT screen the same information is required as for HVAC setup. The compressor type must be centrifugal.

Magnum CENT Information Screen

Information Panel Selector

General Info
 Compressor Info
 Evaporator Info
 Condenser Info
 Lockout Info
 Boiler Info
 CPN Info

Compressor Information

Compressor Type
Centrifugal Comp

Lube State Oil Setpoint
 Sat. Suct Offset
 Actual Temp Value

Keep Running Comp at 100% when starting next?
 Yes
 No

Pre-Pump Out
 Yes
 No

Oil Heater Control Setpoint
 Sat. Suct Offset
 Actual Temp Value

Fast Unload Delay (30-120)
 30 Seconds

Unload Compressor before Starting Next (0-120)
 30 Seconds

Wanted FLA-starting next Compressor
 Calculated FLA
 Use Min FLA-(Stpt #31)

Control of Oil Pump
 Always ON
 Cycle/Needed
 Only Lube State

Rotation Control
 Run Time
 First On / First Off

Last Stage to 100% (Override Setpoint)
 Yes
 No

Minimum Delay Between Compressor Starts
 30 Seconds

When Starting A Compressor
 Start Comp At Max Speed (STPT #129)
 Start Comp At Min Speed (STPT #128)

When Stopping A Compressor
 Pulse Vane Close RO (Vaness Close Slowly)
 Vane Close RO On (Vaness Close Quickly)

The VFD for compressor speed control, VFD fault, and Vane Closed Indicator are specified in the Circuit Base screen if they are used.

Select Output and Sensor Inputs per circuit										
Circuit # (reset button)	Alarm Relay	Comp Proof	Compr Speed(%) or Modulate Hot Gas AO	Compressor Speed Fault	Slide Closed Indicator	Pump Down	Evaporator EXV Output	Flow	Circuit Pump/Valve	
1	...	Not Used	Not Used	COMP1 SPD%	Cmp1VfdFlt	Not Used	C1 DISABLE	EXV 1%	Not Used	Not Used

In the Circuit SI screen the sensors for the Turbine Inlet Pressure and Vane Position are specified if they are used.

Select Temperatures and Refrigeration and Oil Indicators for Circuits										
Circuit # (reset button)	Oil Seal Temp	Pre Oil Filter	Oil Float	Leaving Temp	Refrigerant Temp	Refrig Level	Refrig. Leak Sensor	Turbine Inlet Pressure	Vane Position	
1	...	Not Used	SUCT PSI	HP-OP	Not Used	EVAP TMP	Not Used	SPLY OIL	TURBINE	Not Used

For compressors with a VFD, a Vane Position sensor is required and is used for opening and closing the vanes.

For compressors without a VFD, a Vane Position sensor is optional. If unspecified then the amp sensor is used for opening and closing the vanes. In the above example the Vane Position sensor is not specified; therefore, the vane control will be based upon amp draw.

28

7.1.1 Modbus Fault Sensors

If using a MCS-MODBUS I/O to connect a slave to the MCS-MAGNUM for reading register alarms, you need to setup the 'Sensor Input Information' '**CIRCUIT INDEX**' column to point to the circuit number the Modbus fault sensor belongs to.

The MCS-Magnum supports several special Modbus fault sensor types for reading multiple alarms from one Modbus register. The following are Modbus Fault sensor types:

1. DBCENT1
2. DBCENT2
3. DBCENT3
4. DanFltHi
5. DanFltLo
6. DanFlt2Hi
7. DanFlt2Lo
8. DWarHi
9. DWarLo
10. DWar2Hi
11. DWar2Lo
12. BitFltHi
13. BitFltLo
14. RKNG F1
15. RKNG F2
16. RKNG F3
17. RKNG F4
18. TurboCorFault

See below example of a two comp turbocor config:

Sensor Input Information Screen										
#	Name (1 to 10 char)	Display Type	Offset	Manual Value or NC/NO (select to change)	Display Text (select to change)	Temp./GPM / CFM / Pwr Factor SI	Humd./PSI/ Temp. Diff./ Enthal. Diff.	Auto/Manual (Click here for all)	Circuit Index	Multiplier
1-1	CMP FAULTA	TurboCorFault	Not Used	Open-OFF	OK/TRIP	Not Used	Not Used	Auto	1	Not Used
1-2	Ctrl ModeA	MODBUS	Not Used	0	Not Used	Not Used	Not Used	Auto	Not Used	1
1-3	IGV OPN%A	MODBUS	0	0	Not Used	Not Used	Not Used	Auto	Not Used	1
1-4	TC_SctPSIA	MODBUS	1	0	Not Used	Not Used	Not Used	Auto	Not Used	1
1-5	TC_DisPSIA	MODBUS	0	0	Not Used	Not Used	Not Used	Auto	Not Used	1
1-6	CavityTmpA	MODBUS	0	0	Not Used	Not Used	Not Used	Auto	Not Used	1
1-7	InvertTmpA	MODBUS	0	0	Not Used	Not Used	Not Used	Auto	Not Used	1
1-8	ChokSpeedA	MODBUS	0	0	Not Used	Not Used	Not Used	Auto	Not Used	1
1-9	SurgSpeedA	MODBUS	0	0	Not Used	Not Used	Not Used	Auto	Not Used	1
1-10	ActSpeedA	MODBUS	0	0	Not Used	Not Used	Not Used	Auto	Not Used	1
1-11	CompSIRatA	MODBUS	0	0	Not Used	Not Used	Not Used	Auto	Not Used	1
1-12	3PhaseCurA	MODBUS	0	0	Not Used	Not Used	Not Used	Auto	Not Used	1
1-13	M IGV1STPA	MODBUS	Not Used	0	Not Used	Not Used	Not Used	Auto	Not Used	1
1-14	SuperHeatA	User Logic	0	0	Not Used	Not Used	Not Used	Auto	Not Used	Not Used
1-15	SubcoolA	User Logic	0	0	Not Used	Not Used	Not Used	Auto	Not Used	Not Used
1-16	Superh A2	User Logic	0	0	Not Used	Not Used	Not Used	Auto	Not Used	Not Used
2-1	CMP FAULTB	TurboCorFault	Not Used	Open-OFF	OK/TRIP	Not Used	Not Used	Auto	2	Not Used
2-2	Ctrl ModeB	MODBUS	Not Used	0	Not Used	Not Used	Not Used	Auto	Not Used	1

7.1.2 Typical Relay Output Setup

Typical setup of a centrifugal compressor:

Relay Output Information Screen											
# w/ HELP Button	Name	Slide Multiple	Slide Division	Slide Offset	Design Suction Pressure	Design Disc Pressure	Nominal Tonnage(of Step)	EXV Start (when lead)	EXV off Adj % Diff	Type	Circuit
M-1	COMP	4	20	-10	0	0				Screw NO EXV	
M-2	OPN VANE									Standard	COMP LOAD
M-3	CLS VANE									Standard	UNLOAD
M-4	OIL PUMP									Standard	OIL PMP
M-5	OIL HTR									Standard	OIL HTR
M-6	SPAREM-6									Standard	
M-7	MTR COOL									User Logic	

7.1.3 Compressor Speed Control

Compressor speed is controlled by the associated Analog Output. The speed will only be changed after the vanes are either completely opened (speed will be increased) or closed (speed will be decreased).

7.1.4 Compressor Vane Control

If more capacity is needed the vanes will be opened by pulsing the Open Vane Relay Output (refer to UNIT LOADNG-VANE state). If less capacity is needed the vanes will be closed by pulsing the Close Vane Relay Output (refer to UNIT UNLDNG-VANE state). Vane positioning is based upon the Vane Position sensor if specified. If no Vane Position sensor is used, then the compressor amps are used to determine vane positioning.

Chapter - 8. Centrifugal Status Display

8.1. MCS-Connect

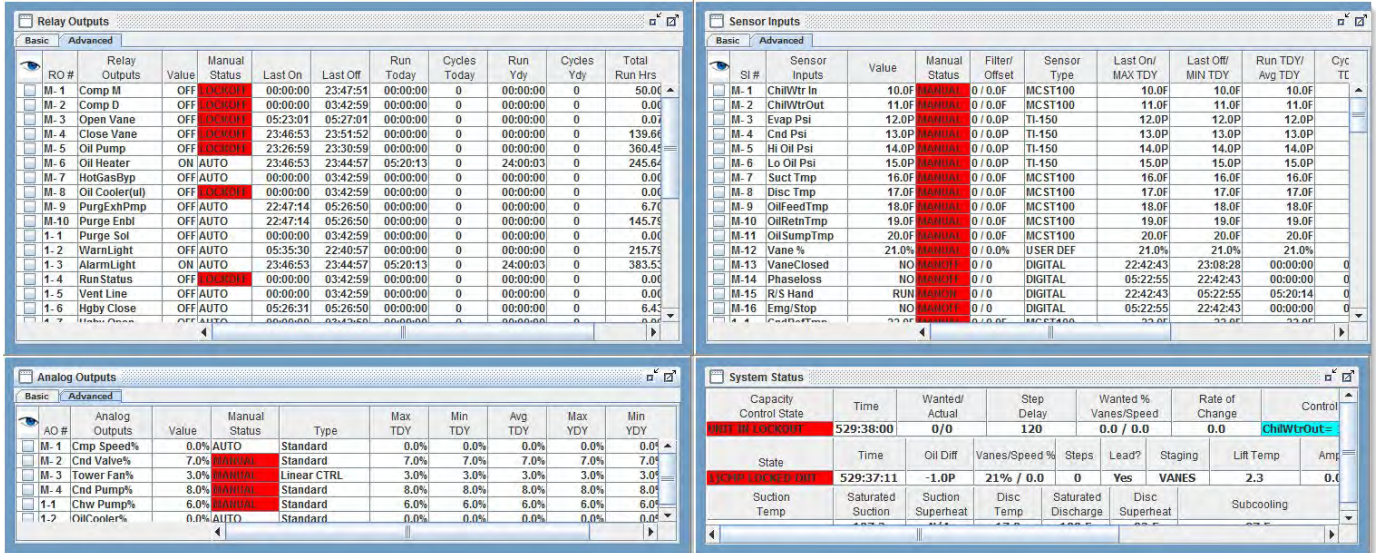

The Control Status for centrifugal compressor portion of the Status screen is shown below.

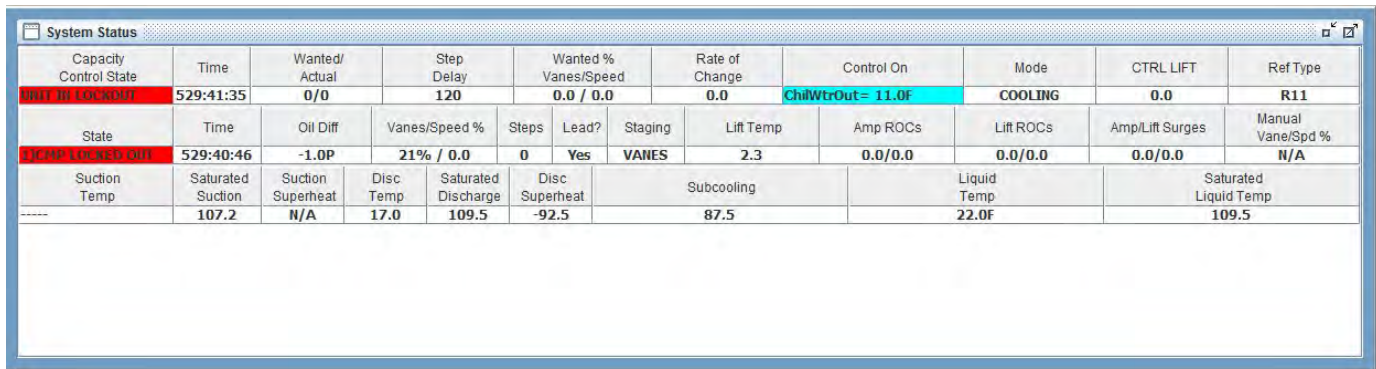

Centrifugal (unit) information is shown in the top section:

- **Capacity Control State**—State of chiller
- **Time**—Time spent in current state. If the state is UNIT IN POWER UP time will count down to zero.
- **Wanted / Actual**—Number of capacity steps Wanted On versus Actual On.
- **Step Delay** – Value that is counted down. The sensitivity and difference between the control sensor and control zone will determine the speed of the countdown. When this value reaches zero, the controller will determine if a change in the system capacity is required.
- **Wanted FLA %**—Wanted Full Load Amp percentage.
- **Rate Of Change** – Rate of Change of control sensor.
- **Control On**—The control sensor value. The name and the reading will be displayed, with color to indicate its relationship to the target Setpoint.
- **Mode**—The mode can be either COOLING or HEATING.
- **CTRL LIFT** – Control Lift = Saturated Discharge Temperature–Saturated Suction Temperature (OR) Turbine Input PSI (converted to temperature).

Compressor information (all active compressors will be displayed):

- **State**—Compressor number and state. The default Compressor number can be changed in MCS-Config with a 3 character entry in the “Comp Name/ID” column of the Circuit Base screen.
- **Time**—Time spent in current state. If the state is CMP ANTICYCLE time will count down to zero.

- Oil Diff–Oil differential pressure. It is calculated as follows:
- Centrifugal compressors: Oil Pressure – Pre-oil Filter Pressure
- FLA %–Full Load Amps based on the compressor’s respective Setpoint.
- Steps–Indicates number of steps associated with this compressor that are turned on.
- Lead?–YES will be displayed for the lead compressor.
- Staging – This field will display “VANES” for centrifugal compressors
- Lift Temp – If an Inlet Pressure sensor is specified in the configuration, then this value will equal Saturated Discharge Temperature – Inlet PSI (converted to temperature). If no Inlet Pressure sensor is present, this value will equal Saturated Discharge Temperature–Saturated Suction Temperature.
- Lift ROC’s – Current lift Rate Of Change/ Last lift Rate Of Change
- Amp/Lift Surges – This field is a counter for the number of amp and lift surges respectively.

Compressor Superheat information:

- Suction Temp–Compressor number and Suction Temperature, if available.
- Saturated Suction–Calculated Suction Saturated Temperature (R22, R134a, R407c, and R410a are supported).
- Suction Superheat–Calculated Suction Superheat, only available if both the Suction Temperature and the Suction Pressure are used. Suction Superheat = Suction Temperature–Suction Saturated Temperature.
- Disc Temp–Discharge Temperature, if available.
- Saturated Discharge–Calculated Discharge Saturated Temperature (R22, R134a, R407c, and R410a are supported).
- Disc Superheat–Discharge Superheat is available only if both the Discharge Temperature and the Discharge Pressure are used. Discharge Superheat = Discharge Temperature–Discharge Saturated Temperature.
- Ref Type – Refrigerant type used.

Chapter - 9. Authorization Function

The authorization code is a special four-character code that enables access to the Magnum controller.

The code may consist of any valid alpha/numeric characters if the system is being accessed through MCS-Connect, however, the code must be numeric with values between 1 and 8 if it is to be entered through the Keypad/Display. Each Magnum can have up to 10 different authorization codes, with four levels of authorization which provide differing levels of functionality. The authorization code and the associated level cannot be viewed or changed through the Keypad/Display or MCS-Connect, but only when the configuration file is opened in MCS-Config. The authorization codes should be protected and remain confidential, or unauthorized personnel may gain access to the system and perhaps cause irreparable damage.

Based upon the authorization level the following changes can be made through the Keypad/Display:

FUNCTION	VIEW	USER	SERVICE	SUPERVISOR	FACTORY	ADMIN
Sensor offsets	NO	NO	YES	YES	YES	YES
Sensor diagnostics	NO	NO	YES	YES	YES	YES
Clear alarm history	NO	NO	NO	NO	NO	YES
Clear point information	NO	NO	NO	NO	NO	YES
Date and time set	NO	YES	YES	YES	YES	YES
Day of week set	NO	YES	YES	YES	YES	YES
Change No Flow Lockout or shut down	NO	NO	NO	NO	YES	YES
Change rotate Yes or No	NO	NO	NO	NO	YES	YES
Change Manual/Auto settings	NO	NO	NO	YES	YES	YES
Change Setpoint values	NO	*	*	*	YES	YES
Change operating schedules	NO	NO	YES	YES	YES	YES
Change holiday dates	NO	NO	YES	YES	YES	YES
Lockout Reset	NO	**	**	**	YES	YES
Change RS485 network settings	NO	NO	YES	YES	YES	YES
Change Ethernet network settings	NO	YES	YES	YES	YES	YES
Adjust Keypad/Display contrast	YES	YES	YES	YES	YES	YES
Transmit Software	NO	NO	YES	YES	YES	YES
Transmit/Receive Configuration	NO	NO	YES	YES	YES	YES

* Setpoints may have individual authorization levels; you must have the proper authorization to view or edit them.

**See the Setup screen of the configuration for authorization level(s) that are allowed unlimited resets per day. Authorization levels below 'Auth Level Bypass' are allowed only a limited number of resets. Authorization levels at and above 'Auth Level Bypass' are allowed unlimited lockout resets.

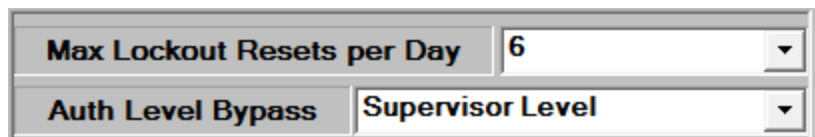

To get authorized through the Keypad/Display do the following:

1. Press 'Menu'
2. Using ↑ ↓, →, or ← keys, move cursor to 'Passwords'
3. Press ←key.
4. Enter 4 digit password and press ↵
5. The authorization will be displayed.
6. Press 'Menu' to make next selection.

To get authorized through MCS-Connect do the following:

The screenshot shows the MCS-Connect software interface. At the top, there is a menu bar with options: File, Setup, Offline, Reset/Clear, Workspace, View, Button Bar, Time, Help. Below the menu bar are several buttons: Disconnect, Scan, Graph, Transmit Cfg, Receive Cfg, View Only (highlighted in red), and Diagnostic Save. The main area displays a table with columns: Site Info, 2 - OFFICE AHU, 1 - HEATPUMP, 6 - PLANT AHU3, 5 - TR ROOM, 7 - PLANT AHU1, 3 - DOWN VAVS, 4 - UP VAVS, and 11 - STI. The table contains data for various units, including their addresses, HW Serial #, Cfg Name, Company Name, Unit Model #, Unit Serial #, and Installed Date.

Address	HW Serial #	Cfg Name	Company Name	Unit Model #	Unit Serial #	Installed Date
192.168.10.4 (2)	001088	OFFICE AHU	MicroCtrlSystem	Cool/Heat/OA		11/13/2012
192.168.10.4 (1)	008038	HEATPUMP	MCS	LL 125 TON		05/05/2015
192.168.10.4 (6)	011492	PLANT AHU3	MCS	AAON	JB-HVAC 14.02F	01/07/2014
192.168.10.4 (5)	010462	TR ROOM	MicroCtrlSystem	Cool/Heat/OA		11/13/2012
192.168.10.4 (7)	012938	PLANT AHU1	MCS	AAON	JB-HVAC 14.05U	01/07/2014
192.168.10.4 (3)	002210	DOWN VAVS	MicroCtrlSystem	12,14,15,16	BCL HVAC 09.10L	06/01/2012
192.168.10.4 (4)	001624	UP VAVS	MicroCtrlSystem	8,10,11,13A,13B	JAT HVAC 09.10Q	08/03/2012
192.168.10.4 (11)	013036	STI	MicroCtrlSystem	Cool/Heat/OA		06/04/2014

1. Click **View Only** on desired Magnum in the Site Information screen.
2. Click button.
3. Enter the 4 digit code into the pop-up box and click ok (or press the enter key).
4. Depending on the authorization level, the button will change to one of the following displays, indicating if the code was accepted or not.



Chapter - 10. Magnum Displays

The following is an examination of all the information screens that can be accessed through both the Magnum keypad and MCS-Connect program.



10.1. Magnum keypad and display

10.1.1 Menu Screen

The main menu is accessed by pressing the “Menu” key.

<u>ACTUAL DISPLAY</u>	<u>DESCRIPTION</u>
<pre> 09:55 Main Menu -Status -Setpoints -Outputs -Serv Tools -Inputs -Lckout RST -Alarms -Lckout ALM -Graphs -Passwords Help LARGE </pre>	<pre> HH:MM Main Menu -Control Status Display -Setpoint Display -Relay and Analog Output Display -Service Tools Display -Sensor Input Display -Lockout Reset Display -Alarm Display -Lockout Alarms Display -Graph Display -Password Display Menu Navigation Help Screen Enlarged Control On Display </pre>

10.1.2 Introduction to Status Screens

The current status of the unit and compressors is displayed by selecting the “Status” option from the “Menu” screen. This following screen will be displayed. By pressing the PG  or PG  function keys you will get additional information on each compressor.

10.1.3 Unit Status

<u>ACTUAL DISPLAY</u>	<u>DESCRIPTION</u>
<pre> 09:55 Unit 45/54 UNIT IS UNLOADED 025:42:33 WTD ACT WTD% DLY ROC 0 0 40% 180 0.0 TARGET=45.0 (ADJ +0.0) PG↑ PG↓ </pre>	<pre> HH:MM CHILLER UNIT LEV/ENT CURRENT CONTROL STATE TIME IN CURRENT STATE WANTED ACTUAL WANTED% DELAY SLOPE #STEPS #STEPS ACTUAL% NEXT CHG DIRECTION TARGET SETPOINT + TARGET RESET PAGE UP PAGE DOWN </pre>

10.1.4 Unit Tonnage and KW Information

<u>ACTUAL DISPLAY</u>	<u>DESCRIPTION</u>
<pre> 09:55 Unit 60/65 UNIT IS UNLOADED 025:42:33 AMP&VLT KW&TON KW/TON 110.0A 73.8K 0.15 388.0V 479T PG↑ PG↓ </pre>	<pre> HH:MM CHILLER UNIT LEV/ENT TMP CURRENT CONTROL STATE TIME IN CURRENT STATE AMPandVLT KwandTON KW/TON Amps Kw Kw/TON with 2 decimals Voltage Tons PAGE UP PAGE DOWN </pre>

If tonnage/KW information is available the following screen is added to the status screens:
 The above screen is based upon flow of 230 GPM and power factor (PF) of 1. All other values in the calculation are displayed on the screen.

10.1.5 Purge Status Screen (only if Purge cycles are active)

<u>ACTUAL DISPLAY</u>				<u>DESCRIPTION</u>		
09:55	PRG 1	45/54		HH:MM	Purge Circuit	LEV/ENT TMP
	A-PRG OFF				CURRENT PURGE STATE	
000:00:42	MODE COOL				TIME IN CURRENT STATE	UNIT MODE
<u>SUC-LT</u>	<u>FLOAT</u>	<u>24TMR</u>		<u>SUC-LT</u>	<u>FLOAT</u>	<u>24 TMR</u>
20F	NORMAL	27mi		Temperature of suction line	Safety Float Status	Purge Run Time in last 24 hours
	PG↑	PG↓			PAGE UP	PAGE DOWN

10.1.6 Compressor status

<u>ACTUAL DISPLAY</u>				<u>DESCRIPTION</u>			
09:56	CMP #1	45/54		HH:MM	COMPRESSOR	LEV/ENT TMP	
	CMP OFF/READY				CURRENT CONTROL STATE		
000:00:30					TIME IN CURRENT STATE		
<u>SUCT</u>	<u>DISC</u>	<u>OPD</u>	<u>MOTOR</u>	<u>SUCTION</u>	<u>DISCHARGE</u>	<u>OIL DIFFERENTIAL</u>	<u>MOTOR</u>
66P	190P	134P	0%	Pressure	Pressure	Pressure	Amp %
55F	177F	----	OK	Temperature	Temperature	----	Status
	PG↑	PG↓			PAGE UP	PAGE DOWN	

<u>ACTUAL DISPLAY</u>				<u>DESCRIPTION</u>			
09:55	CMP #1	45/54		HH:MM	COMPRESSOR	LEV/ENT TMP	
	CMP OFF/READY				CURRENT CONTROL STATE		
000:00:42					TIME IN CURRENT STATE		
<u>SST</u>	<u>SSH</u>	<u>SCT</u>	<u>DSH</u>	<u>SAT.SUCTION</u>	<u>SUCT SHEAT</u>	<u>SAT.COND.</u>	<u>DISC S.HEAT</u>
38	16.9	97	79.2	Temperature	Temperature	Temperature	Temperature
	PG↑	PG↓			PAGE UP	PAGE DOWN	

10.1.7 Compressor status (only CENT)

<u>ACTUAL DISPLAY</u>				<u>DESCRIPTION</u>			
09:55	CMP #1	45/54		HH:MM	COMPRESSOR	LEV/ENT TMP	
	CMP OFF/READY				CURRENT CONTROL STATE		
000:00:42					TIME IN CURRENT STATE		
<u>AROC</u>	<u>LROC</u>	<u>CNT</u>	<u>LIFT</u>	<u>AROC</u>	<u>LROC</u>	<u>CNT</u>	<u>LIFT</u>
0.0A	0.0P	0c	45F	Current Comp.	Current Amp	Lift	Current Lift
0.0A	0.0P	0c	0.8F	Amp R.O.C.	Lift R.O.C.	Count	
	PG↑	PG↓		Last Comp.	Last	Lift	
				Amp R.O.C.	Lift R.O.C.	Count	Lift Ratio
					PAGE UP	PAGE DOWN	

10.1.8 EXV status

<u>ACTUAL DISPLAY</u>				<u>DESCRIPTION</u>			
09:55	EXV #1	45/54		HH:MM	ELECTRONIC EXP VLV	LEV/ENT TMP	
	IS HOLDING				CURRENT CONTROL STATE		
000:36:42					TIME IN CURRENT STATE		
<u>VLV%</u>	<u>DELAY</u>	<u>SPHT</u>	<u>ROC</u>	<u>VLV OPEN%</u>	<u>TIME DELAY</u>	<u>SUCT SHEAT</u>	<u>ROC</u>
27	60	12.2	0.0	Percent	Delay To	Temperature	Rate Of
	PG↑	PG↓			Next Change		Change
					PAGE UP	PAGE DOWN	

Chapter - 11. Magnum Control States

The Magnum controller is a state computer, that is, decisions are made based upon Set points, timers and Sensor Inputs, the controller moves from one state to another.

The controller will change states to ensure the proper functioning of the chiller package.

As we review the various states, we must remember that a chiller package consists of a number of different parts or functions: the compressors and their related items such as unloaders hot gas bypasses, etc.; evaporator; and condensing functions.

Both the Capacity Control States and Compressor Control States are displayed in the Status screens on the Keypad Display. To view the state of the chiller, select the Status option from the menu on the Keypad. You can then view the entire status by using the page up / down function keys. The information can also be accessed through MCS-Connect under status screen by clicking on the CONTROL STATUS button.

Unit Control States (number)

Note: All User Logic points can now access the Unit Control State. The value accessed is the number listed in parenthesis in the following headings.

11.1. UNIT IN POWER UP (0)

This state is entered when the Magnum is powered up or the system has been reset. The system will remain in this state for the time specified in Setpoint #23 "POWER DELAY" or for 60 seconds if not active. In this state all Relay Outputs are turned off. This time delay is to insure the microprocessor has stable power before starting the algorithm.

11.2. NO RUN- I/O LOST (2)

This state will be entered whenever the Magnum loses communications with any of the I/O boards that are connected through the MCS I/O network. When this state is entered the Magnum will generate an MCS I/O offline alarm, which identifies which I/O is offline and a lost I/O shutdown alarm which locks out the unit. Once locked out, if there are ten consecutive successful I/O reads the Magnum will reset and attempt to run. When this occurs a "LOST I/O RESTART" will be generated. Or, the lockout-reset key can be pressed to reset the Magnum, after the lost I/O has been corrected. This will generate a "LOCKOUT RESET." In this state all RO's except ALARM and OIL HEATER are turned OFF.

11.3. UNIT IN LOCKOUT (3)

This state is entered whenever a critical situation is encountered that could cause harm to the chiller package. Items such as freeze protect and emergency stop will force the system into this state. Lockouts can be reset without authorization from the keypad or MCS-Connect program; however if the lockout condition has not been corrected, the system will again be forced into the LOCKOUT state. In this state, all RO's except ALARM and OIL HEATER (for screws with an oil pump) are turned OFF and placed in the "LOCKOUT" state. Note: If the Lockout Reset is pressed more than the programmed allowable number of times in one day the unit cannot be reset during the current day except through MCS-Connect and requires Factory authorization. This number is selected from a drop down menu under the Setup Information button, with a range of 2 to 12.

In Cent Firmware only, Close Vane RO will stay energized for 5 minutes after compressor lockout.

11.4. UNIT IS OFF (4)

This state is entered when the system has finished a STARTUP, DISABLE, LOCKOUT, or NO RUN- I/O LOST state. The chiller is now ready to move into an active state to meet the capacity required.

11.5. UNIT IS HOLDING (5)

This state is entered when one of three conditions exists:

1. The control sensor reading is being maintained within the control zone.
2. Control sensor reading is above the control zone but the Rate of Change is less than the value in the (MAX ROC-, #27) Setpoint. This indicates that the temperature is decreasing toward the target at an acceptable speed. Therefore, no additional cooling is needed at this time.
3. The temperature is below the control zone but the Rate of Change is greater than the (MAX ROC+, #28) Setpoint. This indicates that the temperature is increasing toward the target. Therefore, no reduction in cooling is needed at this time. This state indicates that there is no need to adjust the capacity of the chiller package. This state will end when more or less capacity is required.

11.6. UNIT UNLDNG-VANE (6)

This state is entered when less capacity is required and the vanes are not completely closed. The close vane relay will be modulated. The compressor speed will not be reduced in this state. Control temperature can be below the control zone, or in the zone but the temperature is dropping too fast.

11.7. UNIT IS LOADNG-VANE (7)

This state is entered when more capacity is required (control temperature above control zone) and the vanes are not 100% open. The open vane relay will be modulated. The compressor speed will not be changed in this state.

11.8. OFF-SMOKE ALARM (8)

This state is entered when a smoke alarm has been detected. In the MCS-Configuration file the Smoke Alarm Indicator must be selected in the General Information panel under the MAGNUM screen. When this sensor is trips, an error message "OFF-SMOKE ALARM" is generated and the unit state is changed. In this state all RO's except ALARM and OIL HEATER are turned OFF.

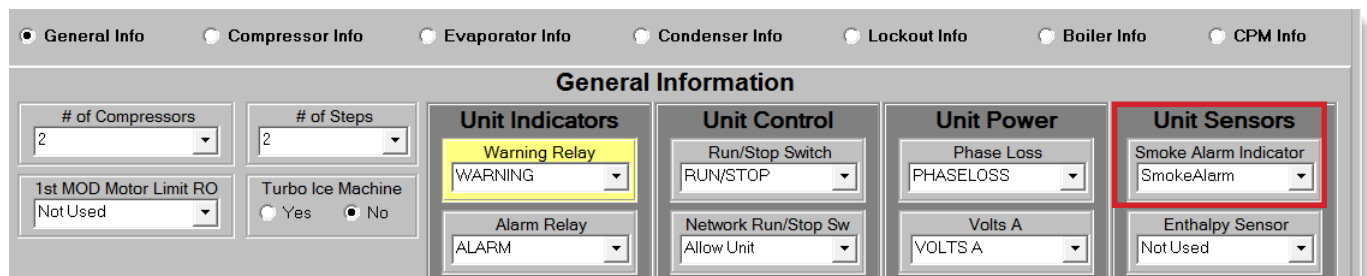

11.9. RUN/STOP SW OFF (9)

This state is entered when the run stop switch is off, in the stop position. When the chiller is in this state, the individual compressor states if active are moved to the CMP IS OFF state through the normal states. One capacity STEP will be moved per second.

11.10. SCHEDULED OFF (10)

This state is entered when the schedule is calling for the package to be off. When the chiller is in this state, the individual compressor states if active are moved to the CMP IS OFF state through the normal states. One capacity STEP will be moved per second.

11.11. OFF- NO FLOW (11)

This state is entered when the evaporator flow switch is off. When the chiller is in this state, the individual compressor states if active are moved to the CMP IS OFF state through the normal states. One capacity STEP will be moved per second. If the NO FLOW Setpoint is active and set to Lockout the chiller will lockout on no flow.

11.12. AMBIENT OFF (13)

This state is entered when the ambient temperature falls below Setpoint #24 "LOW AMB OFF" or is above Setpoint #26 "HIGH AMB OFF". The system will remain in this state until the ambient temperature if low rises 5.0°F (2.5°C) above the "LOW AMB OFF" Setpoint value or if high drops 5.0°F (2.5°C) below the "HIGH AMB OFF" Setpoint value. When the chiller is in this state, the individual compressor states if active are moved to the CMP IS OFF state through the normal staging function. One capacity STEP will be moved per second.

11.13. UNIT IS UNLOADED (15)

This state is entered when all of the systems available capacity steps are off. The package is providing no cooling capacity, as none is required. The system is ready to react to cooling needs.

11.14. UNIT IS LOADED (16)

This state is entered when all of the system's available capacity steps are on and the package is providing the maximum amount of cooling capacity.

11.15. OFF TMP-ICE MADE (17)

This state is only used in systems when the Ice Mode DI On/Off option has been selected. When the system is in the ICE MAKING mode and the control temperature sensor's temperature is less than the target temperature, set point #1, This state is entered. In this state the mode will remain ICE MAKING, all stages of cooling will be staged off and remain off until the ice making mode is exited. Refer to section on 'Ice Making Capabilities'.

11.16. ECONOMIZER ONLY (18)

This state is entered when mechanical cooling is off and the economizer has been specified in the MCS-Configuration setup and it is being used for cooling. Refer to section 7.39 about Economizers.

11.17. SWITCHING MODES (19)

This state is entered when the unit is switching between cooling mode and heating mode. Only heat pump units or units with electric heat and a Sensor Input selects either the cooling or heating mode will enter this state. Select this information under the MAGNUM screen.

The screenshot displays the 'General Information' panel of the MAGNUM control interface. At the top, there are navigation tabs for General Info, Compressor Info, Evaporator Info, Condenser Info, Lockout Info, Boiler Info, and CPM Info. The main panel is divided into several sections:

- Unit Indicators:** Includes Warning Relay (WARNING), Alarm Relay (ALARM), Control Relay (Not Used), Lag Unit ON/OFF Relay (Not Used), and Unit Status Relay (Not Used).
- Unit Control:** Includes Run/Stop Switch (RUN/STOP), Network Run/Stop Sw (Allow Unit), Emergency Stop Switch (EMG/STOP), Heat Control (Heat Mode Indicator: HEAT ENABL), and Common Rev. Valve (Not Used).
- Unit Power:** Includes Phase Loss (PHASELOSS), Volts A (VOLTS A), Volts B (VOLTS B), Volts C (VOLTS C), Unit Amps (UNIT AMPS), and Unit KW (SPARE4-9).
- Unit Sensors:** Includes Smoke Alarm Indicator (SmokeAlarm), Enthalpy Sensor (Not Used), Ambient Temperature (AMBIENT), Ambient Humidity (Not Used), Demand Limit FLA % (Not Used), and Demand Limit Steps (Not Used).

At the bottom left, there are controls for 'Lost BMS Communication' (Run, Stop, No Change) and 'Unit Type' (Cooling Only, HeatPump, Electric Heat). The HeatPump option is selected and highlighted with a red box.

11.18. VaneOpen-SpdHold (19)

This state is entered when the control temperature is above the control zone or in the zone but the control temperature is rising too fast but waiting for an indication that the compressor vanes are fully opened and it is before the compressor speed can be increased. The control temperature is above the control zone.

11.19. UNIT SMOKE UNLDG (20)

This state is entered when the system is unloading because a smoke alarm sensor has tripped. When this sensor is on, an error message "OFF-SMOKE ALARM" is generated and the unit state is changed. See section 6.1.10.

11.20. UNIT OFF UNLDING (21)

This state is entered when the unit has been disabled. It will force a quick unload of the system.

11.21. UNIT DMD UNLDING (22)

This state is only entered when the demand limiting input has been selected. The demand limit sensor must be selected in the General Information panel under the MAGNUM screen and its type must be "485 Dmd Step". This input will indicate the maximum number of steps that the unit can run. If this value is less than the number of steps that are currently on, the unit will unload to meet this value.

11.22. UNIT HEAT UNLDING (23)

This state will be entered and will begin unloading the system if it is in heating mode and the control temperature is greater than the control temperature Setpoint plus Setpoint #164 "HP CTL ZONE +" and the system is not already fully unloaded.

11.23. UNIT UNLDNG-VFD (24)

This state is entered when it is necessary to unload a centrifugal compressor with a VFD and the vanes are fully open. The VFD will be modulated down to minimum speed before the vane positioning is changed.

11.24. UNIT LOADNG-VFD (25)

This state is entered when it is necessary to load a centrifugal compressor with a VFD and the vanes are fully open. The vane positioning will remain the same as the VFD is modulated up to maximum speed.

11.25. CMP SPD OPTIMIZE (33)

Optimize energy efficient on the Centrifugal with VFD. The idea of the new logic is to open the vanes (fully if possible) and reduce the speed of the compressor. By opening the vanes and reducing the speed we save more energy. The compressor is still started with vanes fully closed and speed at 100%. But once the comp going into holding state the optimization can occur.

To use the MCS-Magnum requires CENT 14.00 Z or later and the config modified per this list.

- Make setpoint #188 active and change it's name to "CMP SPEED OPTIMIZE DELAY", this setpoint was used for COMP#19 FLA not used in CENT firmware.
 1. Setpoint #188 type should be set as "DELAY" – so the time in sec
 2. column is adjustable via MCS-Connect.
 3. Setpoint #188 value contains the time delay before comp speed optimization is attempted (typically 300 to 900 seconds)
 4. Setpoint #188 time in sec column contains the delay between optimization adjust to the vane & speed. (typically 3 to 4 seconds)

For optimization to occur all of the following condition must occur:

- Setpoint #188 is active
- capacity control state has been holding for more than the time delay specified by setpoint #188 value
- The comp vanes are less than the max vane setpoint #30
- the comp speed is greater than the min speed setpoint #128
- and the comp has VFD.

Once Optimization state is entered:

- The capacity control state is set to "CMP SPD OPTIMIZE" (new state, requires new MCS-Connect software on touch screens and laptops).
- The comp vanes are opened by setpoint #32 "min adjust%" value every x sec where x is define by the time column in setpoint #188
- The comp speed is reduced by setpoint #32 "min adjust%" value every x sec where x is define by the time column in setpoint #188

Unit will stays in Optimization state until:

- unit wants to load or unload based on water temp (above or below control zone) or
- until the comp vanes are fully open (setpoint #30) or
- until the comp speed is at min allowable (setpoint #128). Min speed is dynamic and calculated based on surge line.

11.26. UNIT IS OFF/TEMP (38)

This state is only used if the low temperature option has been specified. Set point #151 is active and it is a TARGET type of set point. When the steps wanted is zero, no mechanical stages of cooling is on and the control temperature is below the off temperature this state will be entered. Once the control temperature is above this value the unit state will be loading.

Chapter - 12. Compressor Control States (number)

All User Logic points can now access the Compressor Control State. The value accessed is the number listed in parenthesis in the following headings.

The action of the compressor control states may result in an increase or decrease in capacity. The Unit Control States may affect or change the Compressor Control States or supersede them altogether.

12.1. LOST I/O LOCKED (0)

This state is entered when the Capacity Control State is NO RUN- I/O LOST. Resetting the lockout will move the compressor to the CMP OFF/READY state.

12.2. CMP LOCKED OUT (1)

This state is entered when the Capacity Control State is in UNIT IN LOCKOUT or a safety trip has occurred for this compressor (Examples of safety Setpoints include #77 "LOW SUCTION" and #81 "HI DISC PSI"). Lockouts can be reset without authorization from the keypad or MCS-Connect program, however if the condition causing the lockout has not been corrected, the compressor will again be forced into the LOCKOUT State.

12.3. SWITCHED OFF (2)

This state is entered when the compressor is off due to the pump down switch being on or the compressor flow switch being off. In this state the compressor and all related points, including the liquid line solenoid are off. The compressor will not leave this state unless the pump down switch is turned off. If the pump down switch is turned off, the compressor state will be changed to the CMP OFF/READY state.

12.4. UNLD and PMPDWN (3)

This state is entered when the pump down switch has been turned on or if this compressor is no longer Wanted On. The compressor remains on while the liquid line solenoid is closed. This state is active until the suction pressure reaches Setpoint #61 "PMP DWN OFF" or the time has exceeded Setpoint #62 "PMP DWN DELY". The compressor will then move to the CMP ANTICYCE state.

12.5. CMP ANTICYCE (4)

This state is entered when the UNLD and PMPDWN state has been completed. The compressor will stay in this state with all compressor points off for the period of time contained in Setpoint #59 "ACYC OFF-> ON" or Setpoint #63 "ACYC ON -> ON", whichever is longer. The compressor will then move to the OFF state. NOTE: "ACYC ON -> ON" can be used to set the maximum number of compressor starts per hour.

12.6. CMP OFF/READY (5)

This state is entered when no capacity is required from this compressor, or the last state was CMP ANTICYCE, LOST I/O LOCKED, or SWITCHED OFF. In this state the compressor is ready to provide capacity if needed. The compressor will remain in this state for a minimum of 60 seconds.

12.7. OIL PMP LUBING (6)

Screw, centrifugal, and compressors with external oil pumps all use this state. This state is used to ensure proper oil flow prior to compressor startup. Options that affect this state are setup in Compressor Information button under the MAGNUM screen and in the Setpoints screen:

In this state the following Relay Outputs, if present, are set as follows:

1. Compressor relay(s) are OFF.
2. Oil pump is ON.
3. If suction group running is either 1 or 2 the hot gas solenoid is OFF.

Compressor Information	
Lube State Oil Setpoint	
<input checked="" type="radio"/> Sat. Suct Offset	<input type="radio"/> Actual Temp Value
Oil Heater Control Setpoint	
<input checked="" type="radio"/> Sat. Suct Offset	<input type="radio"/> Actual Temp Value
Wanted FLA-starting next Compressor	
<input checked="" type="radio"/> Calculated FLA	<input type="radio"/> Use Min FLA-(Stpt #31)
Control of Oil Pump	
<input checked="" type="radio"/> Always ON	<input type="radio"/> Cycle/Needed
	<input type="radio"/> Only Lube State

4. Fast unloader is ON.
5. First 120 seconds or until the unload switch is ON the unloader is ON else it is OFF.
6. Loader is OFF.
7. VI increase and decrease are OFF.
8. Start unloader is OFF.
9. Low discharge superheat relay is OFF.
10. All liquid line solenoids are OFF.
11. Oil equalization relay is ON.
12. All unloaders are OFF if they are load type else they are ON.
13. All turbo ice relays are off.
14. Oil heater is controlled to maintain oil temperature.

All of the following conditions must be met within the time allowed in Setpoint #41 "LUBE DELAY". If the compressor type is centrifugal an additional 10 seconds will be allowed for these conditions to be met.

NOTE: For dual compressor units with two separate lube delays set setpoint #41 up as a **time type**. Unit state will remain in holding for lube delay (value) plus the time in the time field. The time field must be 30 seconds or greater for the logic to run correctly.

1. Oil differential must be equal to or greater than the value in Setpoint #40 "LUBE OIL PSI". If this Setpoint is not active this test is bypassed.
2. Oil temperature must be equal to or greater than the calculated oil temperature target. If Setpoint #39 "LUBE OIL TEMP" is not active this test is bypassed. If the compressor type is centrifugal and the option to use the saturated temperature is indicated, then the value of the saturated temperature will be added to Setpoint #39 "LUBE OIL TEMP", else the value of Setpoint #39 will be used by itself as the calculated oil temperature target.
3. The compressor must be unloaded. If there is an unloaded indicator it must be on. If it is a centrifugal compressor, it is forced to stay in this state for minimum of 15 seconds. If the compressor has no unloaded indicator it must stay in this state for a minimum of 10 seconds less than Setpoint #41 "LUBE DELAY".

If all of these conditions are met within the allotted time, the compressor will move to another state.

If a fixed step compressor with an external oil pump the state will either be UNLOADED or LOADED, depending if there are multiple compressor steps.

If a variable step compressor, then the percentage wanted on will be checked. If it is less than Setpoint #31 "MIN SLIDE %", or option "Use Min FLA" has been selected, the percentage wanted will be set to the value in Setpoint #31 "MIN SLIDE %" and the state will be set to HOLDING.

Any associated EXV will be adjusted to allow for additional capacity.

If the compressor does not meet all of the conditions it will be LOCKED OUT and an error message will be generated indicating the reason for the failure: pressure, temperature or time.

12.8. NOT USED (7)

12.9. CMP UNLOADED (8)

For variable step compressors, this state occurs when the slide is fully unloaded (indicated by unloaded input or after the unloader is pulsed for 30 seconds with no change). For fixed step compressors, this state occurs when the compressor is on and fully unloaded. In this state the compressor is supplying its minimum cooling capacity.

12.10. CMP DECR SPEED (9)

In this state the compressor speed will be decreased.

12.11. CMP INCR SPEED (10)

In this state the compressor speed will be increased.

12.12. CMP IS HOLDING (11)

This state only applies for variable step compressors. In this state, the required refrigeration capacity of system is being met; no movement of the slide valve is required.

12.13. CMP OPEN VANES (12)

In this state the vanes are being opened because more capacity is required.

12.14. CMP CLOSE VANES (13)

In this state the vanes are being closed because less capacity is required.

12.15. CMP IS RUNNING (14)

For fixed capacity compressors only, this state occurs when the compressor is fully loaded. In this state, the compressor is providing the maximum amount of cooling capacity.

12.16. FAST UNLOADING (15)

For screw compressors only, this state is entered when the compressor is turned on. All load solenoids will be turned off and all unload solenoids will be turned on to ensure the screw is fully unloaded. If an oil pump is included in the system it will be turned on during this state. The time in this state is set in the “Fast Unload Delay” cell under the Compressor Information button in the MAGNUM screen.

Compressor Information			
Compressor Type Hanbell Step		Lube State Oil Setpoint <input checked="" type="radio"/> Sat. Suct Offset <input type="radio"/> Actual Temp Value	
Keep Running Comp at 100% when starting next? <input type="radio"/> Yes <input checked="" type="radio"/> No	Pre-Pump Out <input checked="" type="radio"/> Yes <input type="radio"/> No	Oil Heater Control Setpoint <input checked="" type="radio"/> Sat. Suct Offset <input type="radio"/> Actual Temp Value	
Fast Unload Delay (30-120) 30 Seconds	Unload Compressor before Starting Next (0-120) 0 Seconds	Wanted FLA-starting next Compressor <input checked="" type="radio"/> Calculated FLA <input type="radio"/> Use Min FLA-(Stpt #31)	
Last Stage to 100% (Override Setpoint) <input type="radio"/> Yes <input checked="" type="radio"/> No	Minimum Delay Between Compressor Starts 0 Seconds	Control of Oil Pump <input checked="" type="radio"/> Always ON <input type="radio"/> Cycle/Needed <input type="radio"/> Only Lube State	

12.17. LO SUCT UNLOAD (16)

Refer to Setpoints #77 “LOW SUCTION”; #78 “LO SUCT UNLD”; and #79 “LO SUCT RELD”.

For variable step compressors only. The capacity is being unloaded due to low suction pressure. The compressor will stay in this state until the suction pressure is above Setpoint #79 “LO SUCT RELD”. The system will then move to the LO SUCT HOLD state.

12.18. LO SUCT HOLD (17)

Refer to Setpoints #77 “LOW SUCTION”; #78 “LO SUCT UNLD”; and #79 “LO SUCT RELD”.

Fixed step compressors—This state is entered when a fully loaded compressor that has more than one step is unloading due to low suction pressure. One step of capacity is turned off. The compressor will remain in this state for a minimum of five minutes before returning to the LOADED state if the low suction condition has been corrected.

Variable Step Compressors—Capacity is being held due to low suction pressure. Once the suction pressure returns to a normal operating level the compressor will return to its normal running state.

12.19. HI DISC UNLOAD (18)

Refer to Setpoints #81 “HI DISC PSI”; #82 “HI DISC UNLD”; #83 “HI DISC RELD”; #87 “HI DISC TMP”; #88 “HI DISC UNLD”; #89 “HI DISC RELD”, and #84 “LO DISC SHEAT”.

For variable step compressors only. The capacity is being unloaded due to a high discharge pressure, high discharge temperature, or low discharge superheat. The compressor will stay in this state until the pressure or temperature has dropped below the corresponding Setpoint. The system will then move to the HI DISC HOLD state.

12.20. HI DISC HOLD (19)

Refer to Setpoints #81 “HI DISC PSI”; #82 “HI DISC UNLD”; #83 “HI DISC RELD”; #87 “HI DISC TMP”; #88 “HI DISC UNLD”; and #89 “HI DISC RELD”.

Fixed Step Compressors—This state is entered when a fully loaded compressor that has more than one step is unloading due to high discharge pressure or temperature. One step of capacity will be turned off. The compressor will remain in this state for a minimum of five minutes before returning to the LOADED state if the high discharge condition has been corrected.

Variable Step Compressors—Capacity is being held due to high discharge temperature or pressure. Once the discharge returns to normal operating levels the compressor will return to its normal running state.

12.21. SAFETY TRIPPED (20)

This state is entered when a safety trip occurs but a lockout is not generated. An alarm is generated but the system will automatically restart after the delay specified in the corresponding Setpoint. If a second trip occurs within the time specified in the Setpoint, the compressor will be placed in the CMP LOCKED OUT state.

12.22. LO TMP UNLOAD (21)

The following two conditions can cause this state to be entered and the system to begin unloading:

- 1) The leaving liquid temperature is within 1.5°F of the Setpoint #111 “FREEZE “
- 2) The refrigerant temperature is less than Setpoint #155 “LO REF TMP” if this Setpoint is active.

12.23. LO TMP HOLD (22)

Reload from the “LO TMP UNLOAD” occurs when the leaving liquid temperature is 3.0° F above Setpoint #111 “FREEZE “and the refrigerant temperature sensor, if present, is greater than Setpoint #155 “LO REF TMP” plus twice the value of Setpoint #156 “LO REF TMP”. Until this temperature is reached the system will remain in the LO TMP HOLD State.

12.24. HI AMP HOLD (23)

Fixed step compressors—This state occurs when a fully loaded compressor experiences an abnormally high amp draw. Refer to Setpoints #171-190 for FLA per compressor (compressors 1-20 respectively) and #75 “HI AMPS %”. In this state, one step of capacity will be turned off. The compressor will remain in this state for a minimum of five minutes before returning to the LOADED state if the high amp draw condition has been corrected.

Variable Step Compressors—This state occurs after HI AMP UNLDING. It will remain in this state for the time specified in Setpoint #101 “SAFETY HOLD DELAY”. If the amp draw is less than the FLA Setpoint for this compressor, it will return to the normal operating state and the compressor will be able to load if necessary. In this state the compressor will not load but it can be unloaded if needed.

12.25. HI DIS TMP HLD (24)

Refer to Setpoints #87 “HI DISC TMP”; #88 “HI DISC UNLD”; and #89 “HI DISC RELD”.

This state is entered when a fully loaded compressor that has more than one step encounters a high discharge temperature. One step of capacity will be turned off. The compressor will then remain in this state for a minimum of five minutes before returning to the LOADED state if the high discharge temperature has returned to normal.

12.26. SURGE SPD/VANE (25)

This state is entered when the number of surges has exceeded Setpoint #212 “SurgingCount”. The Magnum will take preventive action to attempt to avoid a safety trip due to excess surges. The compressor speed will increase and the vanes closed.

12.27. HI WATER HOLD (27)

When the compressor is running and Setpoint #86 “HI RETURN TEMP” is active, the Magnum will check for high water temperature. If the control temperature is greater than Setpoint #86 for the time specified the Magnum will place the compressor in this state. The system will be unable to load when in this state.

12.28. OFF-LO OIL TMP (29)

In this state the compressor is disabled. The oil temperature will be checked only if the compressor type is a centrifugal or screw.

Centrifugal compressors—If the temperature is less than the Saturated Suction Temperature plus Setpoint #39 “LUBE OIL TEMP” this state will be entered.

Screw compressors – If the temperature is less than the value in Setpoint #39 “LUBE OIL TEMP” this state will be entered.

12.29. HI AMP UNLDING (30)

For variable step compressors this state is entered when the amp draw is greater than the respective FLA Setpoint plus half the value in Setpoint #75, “HI AMPS”. This action is to prevent a high amps safety trip from occurring. Once the amp draw has been reduced the system state will change to HI AMP HOLD.

Chapter - 13. Lookup Tables

The purpose of Lookup tables is to provide additional capability for entering reference data for reading of sensors. Tables are handy, in that, you do not need to create separate configuration files for each change in the performance curve on a non linear sensor. The Magnum will look at the lookup table to get the right information for that sensor.

13.1. Lookup tables used with MCS-MAGNUM controls

In the sample below, we are using a Temperature sensor. The magnitude of the current is converted to a linear (0-5vdc) output signal which can be read as a standard analog input signal. The signal is used by MCS micro controllers for controlling some of the following:

1. For slide valve positioning on screw machines
2. For high amp motor overload protection
3. For verification of device on / off
4. For reading any temperature, voltage, or current sensors that has typical voltage input which ranges from 0 to 5 Vdc.
5. For reading non linear sensors that use a 4-20mA signal.

13.1.1 Setting up a Lookup table using MCS-CONFIG

1. Setup new temperature sensor in MCS-Config as shown in Screen 1.

Sensor Input Information Screen							
#	Name (1 to 10 char)	Display Type	Offset	Manual Value or NC/NO (select to change)	Display Text (select to change)	Ter	▲ C F
M-1	WTR IN	MCST100	0	55	Not Used	No	
M-2	WTR OUT	MCST100	0	55	Not Used	No	
M-3	SUCT PSI 1	MCS-200	0	33	Not Used	No	
M-4	DISC PSI 1	MCS-500	0	133	Not Used	No	
M-5	OIL PSI 1	MCS-500	0	133	Not Used	No	
M-6	AMPS 1	CT-300	0	21	Not Used	No	
M-7	VOLTS 1	User Defined	0	0	Not Used	No	
▶	M-8 T100XP	Lookup Table SI	0	0	Not Used	No	

Screen 1

2. Using the pull down icon, specified the Lookup table that you will be using for this sensor as shown in screen 2.

The screenshot shows a dialog box titled "Lookup Table SI Form" for sensor "T100XP". It contains several fields and buttons:

- Sensor Display Type (Do this FIRST):** A dropdown menu set to "TEMP".
- Lookup Table Input:** A group box containing:
 - Type:** A dropdown menu set to "SI".
 - Point Index:** A dropdown menu set to "VOLTS 2".
- Lookup Table:** A group box containing:
 - Number:** A dropdown menu set to "Lookup Table #1".
 - Convert Method:** A dropdown menu set to "Estimate Weighted Aver.".
- Buttons:** "OK" and "Cancel" buttons at the bottom.

Screen 2

13.1.2 Setting up Lookup table #1 - see screen 3 below:

The sensor we have setup in this example is a temperature sensor. We are entering data into the lookup table using data from the manufacture of the sensor. In the sample table, we have used 17 rows for the data to give us a clear view of the temperature and voltage range of this sensor.

3. In column one, we have entered the number of rows we will use.
4. The second column we have entered Voltage as the Input
5. In the third column we have entered Temp as the output.
6. The fourth column we have shown Volts2 which will allow the example to have two decimal places for the voltage data.
7. The last column shows the authorization level needed to make changes in MCS-Connect.

Lookup Table Information Screen

Lookup Tables Setup						
#	Number of Rows	Input Column Name	Output Column Name	Input Column Display Type	Output Column Display Type	Minimum Auth Level
1	17	Voltage	Temp	VOLTS-2Dec	TEMP	Factory Level
2	0	Input #2	Output #2	Spare	Spare	View Only
3	0	Input #3	Output #3	Spare	Spare	View Only
4	0	Input #4	Output #4	Spare	Spare	View Only
5	0	Input #5	Output #5	Spare	Spare	View Only

Lookup Table Number

Lookup Table #1

Lookup Table #1		
#	Input Column Voltage	Output Column Temp
1	0	0
2	1.11	32
3	1.18	35
4	1.21	38
5	1.33	40
6	1.45	45
7	1.62	50
8	1.79	55
9	1.88	58
10	1.94	60
11	2.11	65
12	2.27	70
13	2.44	75
14	2.6	80
15	2.76	85
16	2.9	90
17	3.06	95
18	0	0
19	0	0
20	0	0
21	0	0

Screen 3

13.1.3 Viewing the Lookup Table in MCS-Connect

In MCS-Connect we can view the sensor example as shown in Screen 4 and view the same information that we setup in MCS-Config. Changes can be made if you are authorized to view or make changes. We setup the authorization as 'FACTORY' in MCS-Config for this sensor example.

The screenshot displays the MCS-Connect interface. On the left, the 'Sensor Inputs' window shows a list of sensors with columns for SI #, Sensor Inputs, Value, and Manual Status. Sensor M-8 (VOLTS 2) is highlighted in red, showing a value of 1.12V and a manual status of MANUAL.

On the right, the 'Lookup Tables' window is open to 'Table #1 Temp'. It shows configuration options for the number of elements (17), input column name ('Voltage'), input data type ('Volts2dec | 2 | V, V, V'), output column name ('Temp'), and output data type ('TEMP | 1 | F, C, C'). A table on the right side of the window displays the data for 17 elements:

Number	Voltage	Temp
1	0.00	0.0
2	1.11	32.0
3	1.18	35.0
4	1.21	38.0
5	1.33	40.0
6	1.45	45.0
7	1.62	50.0
8	1.79	55.0
9	1.88	58.0
10	1.94	60.0
11	2.11	65.0
12	2.27	70.0
13	2.44	75.0
14	2.60	80.0
15	2.76	85.0
16	2.90	90.0
17	3.06	95.0

At the bottom of the Lookup Tables window, there is a button labeled 'Send Changes for this Table to Controller'.

13.1.3.1. Using as Control Temperature Sensor

The example sensor has been specified in MCS-Config as providing the control value reading. It will normally be the entering temperature, leaving temperature, or suction pressure. The Setpoints must be adjusted according to the type of control measurement selected.

Chapter - 14. Ice Making Capabilities

The Magnum offers a number of different options to meet the requirements of providing ice for energy storage tanks. A system can be configured as a standard HVAC/R unit with the capability to adjust its cooling target or it can be configured as a pure ice making unit.

14.1. HVAC/R unit using the cooling target reset

This method is indicated by selecting the Ice Mode DI On/Off option and a sensor in the Target (SP #1) Reset cell in the Evaporator Info screen of the Information Panel Selector screen. The ice making mode will be entered based upon the sensor selected in the Target (SP #1) Reset cell.

The image shows a screenshot of the 'Evaporator Information' configuration screen. The 'Target Reset' section is highlighted with a red box. In this section, the 'Ice Mode: DI On/Off' radio button is selected, and the 'Target (SP #1) Reset' dropdown menu is set to 'ICE MODE'. The 'Refrigerant Type' is set to 'R22'. Other sections visible include 'Capacity Control' (Control Method: Control Zone), 'Pump/Fan' (Pump/Fan #1A, #1B, #2A, #2B, Flow Switch A, B), 'Process Control' (Process Output Type: Modulating (AO), Process Control Type: VFD (0V-10V)), 'Heat Control' (Defrost Type: None), and 'EXV Control' (Control By The Lowest Superheat In The Suction Group: No).

14.1.1 Target (SP #1) Reset Sensor

This sensor will indicate when the system is to enter the ICE MAKING mode.

14.1.2 Reset Sensor Type 'Target Reset'

When this sensor A/D counts are less than 256, voltage of 1.25, ice mode is to be off, if greater than 768, voltage of 3.75, then ice mode is on else there is no change to the mode.

If this type of sensor is selected, the value of set point #21 will be the off set to set point #1. If set point #1 is 39.0F and the ice temperature target is to be 19.0F then the value of set point #21 must be -20.0F. When this sensor indicates that the ice mode should be entered, its value will be changed to the value of set point #21 & set point #1 will be reset by the value of set point #21, the unit mode will be ICE MAKING.

14.1.3 Reset Sensor Type 'Network Target Reset'

If this type of sensor is selected, its value will be the value received from Modbus address 201 from the network. Set point #21 is used as a high/low limit. The value must be greater than the negative value of set point #21 and less than the value of set point #21 else the value will be 0. This sensor will show this value. If the value of this sensor is not zero, the ice mode will be entered. The value of set point #1 will be reset by the value of this sensor, the unit mode will be ICE MAKING.

14.2. Ice Making Mode

When this mode is entered the unit mode will be changed to ICE MAKING, set point #1 will reflect the ice making target, and all steps of cooling will be staged on. The system will remain in this mode as long as the target reset sensor indicates ice making mode.

If the control temperature drops to the value of set point #1 or less, an information alarm, TMP OFF-ICE MADE, will be generated; all steps of cooling will be staged off; unit state will be OFF TMP-ICE MADE; and the unit mode will remain ICE MAKING. The system will remain in this state until the target reset sensor indicates that the ice making mode is to be terminated.

14.2.1 Terminating of ice making mode

Once the target reset sensor indicates that the ice making mode is to end; the mode will be changed to COOLING, the value of set point #1 will be restored to its cooling target, and the unit state will be to a normal state. At this point the system will function to provide cooling as needed.

14.3. System as a pure ice making unit, Turbo Ice Machine

This setup is used to specify a system that is designed to produce and provide a defrost function.

This method is indicated by selecting the Turbo Ice Machine option and the number of liquid line solenoids in the cell in the General Info screen of the Information Panel Selector screen.

The screenshot shows the 'General Information' configuration screen with the following settings:

- # of Compressors:** 1
- # of Steps:** 1
- 1st MOD Motor Limit RO:** Not Used
- # Liquid Line Solenoid:** 4
- Turbo Ice Machine:** Yes No (highlighted with a red box)
- Lost BMS Communication:** Run Stop No Change
- Unit Type:** Cooling Only HeatPump Electric Heat
- Unit Indicators:** Warning Relay (Not Used), Alarm Relay (ALARM), Control Relay (Not Used), Lag Unit ON/OFF Relay (Not Used), Unit Status Relay (Not Used)
- Unit Control:** Run/Stop Switch (RUN/STOP), Network Run/Stop Sw (Not Used), Emergency Stop Switch (EMG/STOP)
- Heat Control:** Heat Mode Indicator (Not Used), Common Rev. Valve (Not Used)
- Unit Power:** Phase Loss (PHASELOSS), Volts A (Not Used), Volts B (Not Used), Volts C (Not Used), Unit Amps (Not Used), Unit KW (Not Used)
- Unit Sensors:** Smoke Alarm Indicator (Not Used), Enthalpy Sensor (Not Used), Ambient Temperature (Not Used), Ambient Humidity (Not Used), Demand Limit FLA % (Not Used), Demand Limit Steps (Not Used)
- Vestibule Control:** Temp Control Sensor (Not Used), Fan Relay (Not Used), Cooling Relay (Not Used), Heating Relay (Not Used)

14.3.1 The # of Liquid Line Solenoids

The number may be 1 thru 4 and indicates the number of groups of liquid line solenoids/hot gas defrost solenoids output relays.

Each group must consist of a liquid line solenoid and followed by three hot gas solenoid relays. The first group will follow the normal relay output sequence each additional group must follow the previous group.

The following is an example of relay outputs when 4 liquid line solenoids have been specified.

Note, in this example in the Circuit Base grind the # of Comp RO's will be 19.

Number	Name	Slide Mult.	Slide Div.	Slide Off.	Design Suc.PSI	Design Dis.PSI	Nominal Tonnage(of Step)	EXV Start (When Lead)		Circuit
M-1	COMP	80	10	20	68	340	---	---	Screw NO E	1
M-2	LOAD	---	---	---	---	---	---	---	Standard	COMP LOAD UNLOAD LLS
M-3	UNLOAD	---	---	---	---	---	---	---	Standard	
M-4	LLS1	---	---	---	---	---	---	---	Standard	
M-5	HGDEF1	---	---	---	---	---	---	---	Standard	
M-6	HGDEF2	---	---	---	---	---	---	---	Standard	
M-7	HGDEF3	---	---	---	---	---	---	---	Standard	
M-8	LLS2	---	---	---	---	---	---	---	Standard	
M-9	HGDEF4	---	---	---	---	---	---	---	Standard	
M-10	HGDEF5	---	---	---	---	---	---	---	Standard	
1-1	HGDEF6	---	---	---	---	---	---	---	Standard	
1-2	LLS3	---	---	---	---	---	---	---	Standard	
1-3	HGDEF7	---	---	---	---	---	---	---	Standard	
1-4	HGDEF8	---	---	---	---	---	---	---	Standard	
1-5	HGDEF9	---	---	---	---	---	---	---	Standard	
1-6	LLS4	---	---	---	---	---	---	---	Standard	
1-7	HGDEF10	---	---	---	---	---	---	---	Standard	
1-8	HGDEF11	---	---	---	---	---	---	---	Standard	
1-9	HGDEF12	---	---	---	---	---	---	---	Standard	

14.3.2 Required set points for defrost cycles

#116, if the control sensor's temperature is less than or equal to this value, defrost cycles are required.

#117, time that the system will wait before between defrost cycles.

#118, time that each hot gas defrost relay will be on.

#	Name	Value	Min	Max	Adjust Value	Time (SEC)	Max Time Allowed (SEC)	Lockout Delay (HRS)	Safety Down Time(MIN)	Active or Non-Active	Select Value: # decimals & print char
116	DEF on Temp	38	30	40	0.5	0	0		0	Active	TEMP
117	DEF on Delay	120	60	600	1	0	0		0	Active	SECONDS
118	DEFon Cycle	60	30	300	1	0	0		0	Active	SECONDS

14.4. Turbo Ice Machine Operation

a) Capacity control

The unit capacity will be increased & decreased to meet the required target temperature in set point #1.

b) Non defrost cycle

When the system is not defrosting all liquid line solenoids will be ON and all hot gas solenoids will be OFF.

c) Defrost cycle initiated

A defrost cycle is required when the control sensor's temperature is less or equal to the value in set point #116, a delay of the value in set point #117 before the defrost cycle begins.

d) Defrost cycle

The defrost cycle will rotate through each group's hot gas solenoids and when all have been accessed then move to the next group.

Following table shows the relay status of a defrost group:

Relays	*1	*2	*3	*4	*5	*6	*7
Liquid Line Solenoid	ON	OFF	ON	OFF	ON	OFF	ON
Hot Gas Solenoid 1	OFF	ON	OFF	OFF	OFF	OFF	OFF
Hot Gas Solenoid 2	OFF	OFF	OFF	ON	OFF	OFF	OFF
Hot Gas Solenoid 3	OFF	OFF	OFF	OFF	OFF	ON	OFF

*1, status prior to defrost cycle.

*2, defrost cycle begins with first hot gas solenoid, state will remain for time in set point #118.

*3, delay between rotations to next hot gas solenoid, state will remain for time in set point #117.

*4, rotation to next hot gas solenoid, #2, state will remain for time in set point #118.

*5, delay between rotations to next hot gas solenoid, state will remain for time in set point #117.

*6, rotation to next hot gas solenoid, #3, state will remain for time in set point #118.

*7, all hot gas solenoids in this group have been accessed. Value of set point #117 will be the time delay before the next group begins a defrost cycle.

e) Terminating a defrost cycle

A defrost cycle will be terminated when the control sensor's temperature is greater or equal to the value in set point #116 plus .5. If another defrost cycle is initiated the cycle will begin where the previous defrost cycle ended.

Chapter - 15. Centrifugal Purge Setup and Operation

15.1. External Purge System

Firmware Version 17.62R Config Ver. 18.01T

Since many centrifugal compressors operate in a vacuum, there is an opportunity for contaminants to get into the system from small leaks or minor servicing errors. These contaminants are classified as non-condensable requiring a method of disposal, known as purging.

A purge system is externally mounted on the chiller and its purpose is to remove the non-condensable. The external purge system has two main subsystems, refrigeration circuit and Purge Tank. The function of refrigeration circuit subsystem is to collect the non-condensable into the purge tank. The function of the purge tank is to exhaust the non-condensable.

Examples of external purge systems are the Redi-Purge®, Trane Purifier® or EarthWise®.

15.1.1 External Purge System MCS-Magnum's Configuration Setup

To configure the MCS-Magnum to control an external purge system, Setpoint #163 “Purge Target” must be active.

Setpoint Information Screen																		
#	Name	Value	Min	Max	Adjust Value	Time (SEC)	Max Time Allowed (SEC)	Lockout Delay (HRS)	Safety Down Time(MIN)	Active or Non-Active	Select Value: # decimals & print char	Level Of Auth. To Display	Type of Setpoint	Comments	SEC to Ignore Safety	Window to Ext. Safety Time(SEC)	Safety Time Extension (SEC)	
159	AdaptPurgOff	120	60	600	1	0	0	0	0	Active	... MINUTES	View Only	Setpoint		
160	AdaptNoPurge	60	30	300	1	0	0	0	0	Active	... MINUTES	View Only	Setpoint		
161	DEF TERM TMP	0	0	0	0	0	0	0	0	Non-Active	... TEMP	View Only	Setpoint		
162	DEF-RelayDelay	0	0	0	0	0	0	0	0	Non-Active	... SECONDS	View Only	Setpoint		
163	PURGE TARGET	18	-20	80	1	30	30	0	0	Active	... TEMP	View Only	Alarm		0	0	0	
164	PurgeFitTime	10	10	1200	1	0	0	0	0	Active	... SECONDS	View Only	Lockout		0	0	0	
165	PurgeExhTime	20	1	100	1	0	0	0	0	Active	... MINUTES	View Only	Setpoint		
166	PHASE LOSS	0	0	0	0	2	2	0	1	Active	... MINUTES	View Only	Alarm		0	0	0	
167	PurgeAlarm	80	40	100	1	0	0	0	0	Non-Active	... DIGITAL / SW	View Only	Setpoint		

In MCS-Config’s Setpoint Information Screen the following setpoints are used to control the external purge system:

- **Setpoint #159 “AdaptPurgOff”** is optional and required when using adaptive purge mode. This setpoint’s value contains the time (in minutes) to turn off the external purge system when no purge exhaust cycles have been detected
- **Setpoint #160 “AdaptNoPurge”** is optional and is required when using the adaptive purge mode. This setpoint’s value contains the time (in minutes) required for the purge enable relay to be ON without any purge exhaust cycles before the adaptive purge logic will turn off the purge enable relay.’
- **Setpoint #163 “Purge Target”** when active, it enables MCS-Magnum’s external purge logic and its value is used to trigger the purge exhaust cycle. When the purge suction temperature is less than or equal to this setpoint value, a purge exhaust cycle is started. For example, Purge exhaust pump turns on and 1 second later purge solenoid is turned on. When the purge suction temperature rises above setpoint #163 value field + Setpoint #163 Time (sec) assumed 1 decimal, the purge exhaust cycle is stopped and purge exhaust pump relay is turned off and 1 second later the purge solenoid is turned off.
- **Setpoint #164 “PurgeFitTime”** – if active and the purge safety sensor input is setup (not equal to UN-USED) the purge fault logic is run. The purge fault logic looks for the purge fault sensor input to be ON for 10 seconds (setpoint #164 value field) before generating a Purge Fault alarm and lockout the external purge system.
- **Setpoint #165 “PurgeExhTime”**- if active and the exhaust purge system has been in the purge exhaust cycle for more than 120 minutes (Setpoint #165 value field) an Excessive Purging alarm is generated.

In MCS-Config’s Circuit Base Screen, the “Purge Relay and Sensors” section must be setup.

Purge Relays and Sensors							
	Circuit # (reset button)	Purge Enable RO	Purge Solenoid RO	Purge Exhaust Pump RO	Purge Mode Switch SI	Purge Safety Switch SI	Purge Suction Temp SI
▶	1	...	PURGE	P-SEL	P-PUMP	MODE SW	SAFETY SW
							PrgSucTEMP

- **Purge Enable RO** – This is the MCS-Magnum’s relay output that will enable the purge refrigeration subsystem, for example, the purge compressor.
- **Purge Solenoid RO** – This is the MCS-Magnum’s relay output for the purge tank subsystem’s solenoid valve.
- **Purge Exhaust Pump RO** – This is the MCS-Magnum’s relay output for the purge tank subsystem’s exhaust pump.
- **Purge Mode Switch SI** – This is the MCS-Magnum’s sensor input for the Purge Mode selector switch. This selector switch can be a three way or four-way switch. The following purge modes are selectable by this switch:

Sensor Input Information Screen								
Point Number	Name (1 to 10 char)	Display Type	Offset	Manual Value or NC/NO (select to change)	Display Text (select to change)	Temp. / GPM / CFM / Pwr Factor SI	Humd./PSI/ Temp. Diff./ Enthal. Diff.	
1-16 ...	PurgeMode	MODE SEL SW	0	0	Not Used	Not Used	Not Used	
2-1 ...	PurgSucTmp	MCST100	0	55	Not Used	Not Used	Not Used	
2-2 ...	PurgLiqTmp	MCST100	0	65	Not Used	Not Used	Not Used	
2-3 ...	PurgSafety	DIGITAL	Not Used	Closed=OFF	OK/TRIP	Not Used	Not Used	
2-4 ...	CarbonTemp	User Defined	0	0	Not Used	Not Used	Not Used	

- **OFF** – The external purge system is forced off and all purge relay outputs are turned off. The purge state is set to “SWITCHED OFF”.
- **ON** – The external purge system is forced on always. In this mode the purge enable relay output is always on and the purge exhaust relay and purge solenoid relay outputs are cycled on/off as required to exhaust the non-condensables.
- **AUTO** – The external purge system is forced off when the Centrifugal compressor is off. And when the centrifugal compressor is on, the purge enable relay output is turned on and purge exhaust relay and purge solenoid relays are cycled on/off as required to exhaust the non-condensables. In firmware version CENT 17.XXX or greater the adaptive logic is also used in Auto mode when the purge relay is ON. Meaning if the purge enable relay has been ON for 60 minutes (60 minutes is defined by setpoint #160 “AdaptNoPurge” value) and no exhaust cycle have occurred, then the purge enable relay is turned off for 120 minutes (120 min is defined by setpoint #159 “AdaptPurgOff” value)
- **ADAPTIVE** - (only supported in MCS-Magnum firmware version 17.XXX or greater) The external purge system is forced on and only turned off when no purge exhaust cycles have occurred for 60 minutes (60 minutes is defined by setpoint #160 “AdaptNoPurge” value). Once no exhaust cycles has occurred the purge enable relay is turned off for 120 minutes (120 minutes is defined by setpoint #159 “AdaptPurgOff” value). Once 120 minutes has elapsed, the purge enable relay is turned back on.
- **Purge Mode Selection Switch Wiring**
 - There are two options for the mode selector switch:
 1. Three position switch with two normally open dry contacts and switch positions of ON, OFF and Auto modes.
 2. Four position switch with three normally open dry contacts and switch positions of ON, OFF, Auto and Adaptive modes.
 - **ON MODE** - a 100K ¼ watt resistor is wired thru a dry set of contacts between +5vdc and S1 terminals on the sensor input. When the dry contacts are closed this will apply approximately 2.5vdc to S1 terminal.
 - **OFF MODE** - is open sensor, nothing is wired to the S1 terminal. This will apply 0vdc to the S1 terminal.
 - **AUTO MODE** - the +5vdc is wired thru a dry set of contacts to S1 terminal. This will apply 5vdc to the S1 terminal.

- **ADAPTIVE MODE** - a 50K ¼ watt resistor is wired thru a dry set of contacts between +5vdc and S1 terminals on the sensor input. When the dry contacts are closed this will apply approximately 3.75vdc to S1 terminal.
- **Purge Safety Switch SI** – This is the MCS-Magnum’s sensor input for detecting a purge fault. If this sensor input is on for longer than the value in Setpoint #164 “P-FaultTimer” all purge relay outputs will be locked off and an alarm message will be generated. This will have no effect on the control of the centrifugal compressor.
- **Purge Suction Temp SI** - This is the MCS-Magnum’s sensor input for the purge suction temperature. When the purge enable relay is ON and the purge suction temperature sensor input is less than or equal to 18F (setpoint #163 “Purge Target”) this indicates the purge tank is full of non-condensable and a purge exhaust cycle is required.

15.1.2 External Purge System States

SWITCHED OFF – The mode selection switch is in the OFF position and purge relays outputs are all turned off.

FLOAT FAULT–The purge safety switch has been on longer than the value in Setpoint #164 “Purge Fault”. All purge Relay Outputs will be LOCKED OFF. When this switch returns to the normal off position, the purge Relay Outputs will be changed to AUTO and the purge state will be set to M-PRG Running, A-PRG OFF or ADAPTIVE OFF based on the purge selection switch.

M-PRG RUNNING – The purge relay enable is turned on and never cycled off. The purge exhaust and solenoid relays are cycled as needed (control by purge suction temperature sensor) to exhaust the non-condensables.

A-PRG OFF – The mode selection switch is in the AUTO position and the centrifugal compressor is off, all the purge relay outputs are turned OFF.

A-PRG RUNNING – The mode selection switch is in the AUTO position and the centrifugal compressor is ON, the purge relay enable is turned on and the purge exhaust and solenoid relays are cycled as needed (controlled by purge suction temperature sensor) to exhaust the non-condensables. In firmware version CENT 17.XXX or greater, if setpoint 159 and 160 are active, if the purge enable relay has been turned on and no purge exhaust cycles have occurred for 60 minutes (60 minutes defined by setpoint #160 “AdaptNoPurge” value), the purge enable relay is turned off for 120 minutes (120 min define by setpoint #159 “AdaptPurgOff” value). Once 120 minutes has elapsed, the purge enable relay is turned back on.

ADAPTIVE OFF – (This mode is only supported in firmware version CENT 17.XXX or greater) The mode selection switch is in the ADAPTIVE position and all the purge relays are turned OFF. When the purge enable relay has been turned off of 120 minutes (120 min defined by setpoint #159 “AdaptPurgOff” value) the state is set to ADAPTIVE ON.

ADAPTIVE ON – (This mode is only supported in firmware version CENT 17.XXX or greater) The mode selection switch is in the ADAPTIVE position and purge relay enable is on and the purge exhaust and solenoid relays are cycled as needed to exhaust the non-condensables. If the purge enable relay has be on for 60 minutes (60 minutes defined by setpoint #160 “AdaptNoPurge” value) and no exhaust cycles have occurred, the purge state is set to ADAPTIVE OFF and all purge relays are turned off.

15.1.3 External Purge System Alarms

- EXCESS PURGING
- FLOAT FAULT

15.2. Purge Carbon Tank Regeneration (Optional) - Rev 1.0

Requires MCS-Magnum CENT 17.62R or greater, MCS-Config 18.01T or greater

The Purge Carbon Tank is used to absorb refrigerant that may be blended in with the exhausted non-condensables. The carbon tank must be periodically regenerated to remove the refrigerant that has been absorbed.

The function of the MCS-Magnum Purge Carbon Tank Regeneration logic is to determine when to trigger the regeneration cycle and perform the regeneration cycle.

The MCS-Magnum stores the accumulated run time for the purge exhausting relay output. A regeneration cycle is triggered when one of the following conditions occur:

1. A regeneration cycle will occur if the compressor is running and no purge exhausting has occurred for 60 minutes (setpoint #160 Adapt NoPurge) and the capacity of the carbon tank is less than or equal to 70% (setpoint #233 RegenChlOn%) of the maximum carbon Regen capacity time of 500 minutes (setpoint #226 RegenCapTime) (500 x .7=350 minutes). So if the purge exhaust relay on time has subtracted enough from the max capacity time to be at 350 minutes or less then a regeneration cycle is performed.
2. If the compressor is off and no purge exhausting has occurred for 60 minutes (setpoint #160 AdaptNo-Purge) and the carbon tank capacity falls below 50% (setpoint #234 RegenChlOff%) of the maximum carbon Regen capacity time of 500 minutes (setpoint #226 RegenCapTime) (500 x .5=250 minutes). If the purge exhaust relay on time has subtracted enough from the max capacity time to be at 250 minutes or less then a regeneration cycle is performed.
3. If no regeneration has been performed based on the comp on and off percentages then a regeneration cycle will be performed when 0% is reached.

Once the regeneration cycle is started, the carbon heater and valve relays are turned on and all other purge relays are turned off. It will remain in the heating period until the carbon tank temperature reaches 240F or for a maximum of 4 hours.

Once the heating period has terminated, a cool down period is started. The carbon heater and valve are turned off, and purge enable relay is turned on. It will remain in the cool down period until the carbon tank temperature drops below 100F or for a maximum of 4 hours.

Once the cool down period has terminated the purge unit returns to normal operation.

15.2.1 **Carbon Tank Regeneration MCS-Magnum's Configuration Setup**

To configure the optional Carbon Tank Regeneration logic, the following MCS-Magnum configuration settings are required:

15.2.1.1. **Relay Outputs Configuration:**

- Carbon Tank Regeneration Heater
- Carbon Tank Regeneration Valve

Relay Output Information Screen										
Point Number	Name	Slide Mult.	Slide Div.	Slide Off.	Design Suc. PSI	Design Dis. PSI	Nominal Tonnage(of Step)	EXV Start (When Lead)	Type	
1-6 ...	RegenValve	---	---	---	---	---	---	---	Standard	
1-7 ...	RegenHeat	---	---	---	---	---	---	---	Standard	
1-8 ...	SpareR1-8	---	---	---	---	---	---	---	Standard	

15.2.1.2. **Sensor Input Configuration:**

- Carbon Tank Temperature

Point Number	Name (1 to 10 char)	Display Type	Offset	Manual Value or NC/NO (select to change)	Display Text (select to change)
2-3	PurgSafety	DIGITAL	Not Used	Closed=OFF	OK/TRIP
2-4	CarbonTemp	User Defined	0	0	Not Used
2-5	SpareR2-5	SPARE	0	0	Not Used

15.2.1.3. Circuit Base setup

- Point to the below circled points:

Purge Relays and Sensors									
Circuit # (reset button)	Purge Enable RO	Purge Solenoid RO	Purge Exhaust Pump RO	Purge Mode Switch S1	Purge Safety Switch S1	Purge Suction Temp S1	Regeneration Solenoid Valve	Regeneration Carbon Heater	Regeneration Carbon Tank Temp
1	PurgeEnable	PurgeSol	PurgExhPmp	PurgeMode	PurgSafety	PurgSucTmp	RegenValve	RegenHeat	CarbonTemp

15.2.1.4. **Setpoint Configuration:**

#	Name	Value	Min	Max	Adjust Value	Time (SEC)	Max Time Allowed (SEC)	Lockout Delay (HRS)	Safety Down Time(MIN)	Active or Non-Active	Select Value: # decimals & print char	Level Of Auth. To Display	Type of Setpoint
225	Reserved 225	0	0	0	1	0	0	0	0	Non-Active	...	Spare	View Only Setpoint
226	RegenCap Time	500	1	1000	5	0	0	0	0	Active	...	MINUTES	View Only Setpoint
227	RegenTerm Tmp	240	120	600	5	0	0	2	10	Active	...	TEMP	View Only Alarm
228	RegTerm Time	240	1	600	5	0	0	2	10	Active	...	MINUTES	View Only Alarm
229	HiRegen Temp	290	250	300	1	0	0	2	10	Active	...	TEMP	View Only Lockout
230	Reserved 220	0	0	0	1	0	0	0	0	Non-Active	...	Spare	View Only Setpoint
231	RegNo TmpRise	12.5	5	50	1	3600	3600	2	10	Active	...	TEMP	View Only Alarm
232	RegNo TmpDecr	12.5	5	50	1	3600	3600	2	10	Active	...	TEMP	View Only Lockout
233	RegenChlOn%	70	5	90	1	0	0	0	0	Active	...	HUMD or %	View Only Setpoint
234	RegenChlOff%	50	5	90	1	0	0	0	0	Active	...	HUMD or %	View Only Setpoint
235	SETPOINT-235	0	0	0	0	0	0	0	0	Non-Active	...	Spare	View Only Setpoint
236	SETPOINT-236	0	0	0	0	0	0	0	0	Non-Active	...	Spare	View Only Setpoint
237	SETPOINT-237	0	0	0	0	0	0	0	0	Non-Active	...	Spare	View Only Setpoint
238	SETPOINT-238	0	0	0	0	0	0	0	0	Non-Active	...	Spare	View Only Setpoint
239	SETPOINT-239	0	0	0	0	0	0	0	0	Non-Active	...	Spare	View Only Setpoint
240	SETPOINT-240	0	0	0	0	0	0	0	0	Non-Active	...	Spare	View Only Setpoint
241	AmpImbal	20	10	50	1	15	45	2	10	Active	...	HUMD or %	View Only Lockout
242	SETPOINT-242	0	0	0	0	0	0	0	0	Non-Active	...	Spare	View Only Setpoint
243	SETPOINT-243	0	0	0	0	0	0	0	0	Non-Active	...	Spare	View Only Setpoint
244	SETPOINT-244	0	0	0	0	0	0	0	0	Non-Active	...	Spare	View Only Setpoint
245	SETPOINT-245	0	0	0	0	0	0	0	0	Non-Active	...	Spare	View Only Setpoint
246	RegenCool Tmp	100	75	125	1	0	0	0	0	Active	...	TEMP	View Only Setpoint
247	RegenCool Tim	240	1	600	5	0	0	0	0	Active	...	MINUTES	View Only Setpoint

- **Setpoint #226 - “REGENCap Time”** - Value of this setpoint is the maximum time it takes the carbon capacity to go from 100% to 0 %.
- **Setpoint 227 “RegenTermTmp”** - If setpoint #227 is setup as an “ALARM” type, then this event is logged in the MCS-Magnum alarm history. This is an event notice only. If setpoint #227 is not setup as an “ALARM” type, the event is not logged in the MCS-Magnum alarm history.
- **Setpoint #228-”RegTermTime”** - If setpoint #228 is setup as an “ALARM” type, then these event are logged in the MCS-Magnum alarm history. This is an event notice only. If setpoint #228 is not setup as an “ALARM” type, the event is not logged in the MCS-Magnum alarm history.

- **Setpoint #229 “HiRegenTemp** - If setpoint #229 is active and carbon tank temperature reaches or excess the setpoint’s value, an alarm is generated, and the purge unit is locked out and all purge relays locked off.
- **Setpoint #231 - “RegNoTmpRise”** - If setpoint #231 is active and carbon tank temperature does increase more than the setpoint’s value with the time defined by the setpoint time field, an event alarm is generated. This is an event notice only.
- **Setpoint #232 “RegNoTmpDecr”** - If setpoint #232 is active and carbon tank temperature does decrease more than the setpoint’s value with the time defined by the setpoint time field, an event alarm is generated. This is an event notice only.
- **Setpoint #233 “RegenChlOn%”** - When compressor is running and no purge exhausting has occurred for 60 minutes (setpoint #160) and the capacity of the carbon tank is less than or equal to this value of the capacity (setpoint #226) perform a regeneration cycle.
- **Setpoint #234 “RegenChlOff%”** - When compressor is off and no purge exhausting has occurred for 60 minutes (setpoint #160) and the carbon tank capacity is less than or equal to this value of the capacity (setpoint #226) perform a regeneration cycle.

15.2.2 External Purge System Carbon Regeneration States

REGEN HEATING – This state indicates a regeneration cycle has been triggered and carbon heater relay output is turned on. When the regeneration cycle is started, the carbon tank temperature is saved and a rise of 12.5F (setpoint #231) must occur when 3600 seconds(60mins) or a “RegNoTmpRise” alarm is generation. The logic will remain in this state until the Carbon tank temperature reaches 240F (setpoint #227) or for maximum time of 240 mins (setpoint #228).

In this state the RegenValve and RegenHeat relays are turned on and all the other purge relay outputs are turned off.

REGEN COOL DWN – This state is entered once the REGEN HEATING state has terminated due to temperature or time. When the regeneration cool down cycle is started, the carbon tank temperature is saved and a decrease of 12.5F (setpoint #231) must occur when 3600 seconds(60mins) or a “RegNoTmpDecr” alarm is generation. The logic will remain in this state until the Carbon tank temperature drops below 100F (setpoint #246) or for a maximum time of 240 mins (setpoint #247). Once either of these two conditions is met, the carbon regeneration cycle is complete and the purge unit returns to normal control.

In this state the PurgEnable relay is turned on and all the other purge relay outputs are turned off.

REGEN HI TEMP – This state is entered if the carbon tank temperature reached 290F or higher (setpoint #229). If this high temperature condition occurs an alarm is generated, and the purge operation is locked out and all purge relays are locked off.

15.2.3 Carbon Tank Regeneration Alarms

The following alarms are generation by the Carbon Regeneration Logic.

- **RegenTermTmp**
If setpoint #227 is setup as an “ALARM” type, then this event is logged in the MCS-Magnum alarm history. This is an event notice only. If setpoint #227 is not setup as an “ALARM” type, the event is not logged in the MCS-Magnum alarm history.
- **RegTermTime**
If setpoint #228 is setup as an “ALARM” type, then these event are logged in the MCS-Magnum alarm history. This is an event notice only. If setpoint #228 is not setup as an “ALARM” type, the event is not logged in the MCS-Magnum alarm history.
- **HiRegenTemp**
If setpoint #229 is active and carbon tank temperature reaches or excess the setpoint’s value, an alarm is

generated, and the purge unit is locked out and all purge relays locked off.

- **RegNoTmpRise**

If setpoint #231 is active and carbon tank temperature does increase more than the setpoint's value with the time defined by the setpoint time field, an event alarm is generated. This is an event notice only.

- **RegNoTmpDecr**

If setpoint #232 is active and carbon tank temperature does decrease more than the setpoint's value with the time defined by the setpoint time field, an event alarm is generated. This is an event notice only.

- **RegenCoolTmp**

If setpoint #246 is setup as "ALARM" type, then this event is logged in the MCS-Magnum alarm history. This is an event notice only. If setpoint #246 is not setup as an "ALARM" type, the event is not logged in the MCS-Magnum alarm history.

- **RegenCoolTime**

If setpoint #247 is setup as an "ALARM" type, then this event is logged in the MCS-Magnum alarm history. This is an event notice only. If setpoint #247 is not setup as an "ALARM" type, the event is not logged in the MCS-Magnum alarm history.

MCS Connect will display one of the following based on the type of purge that is setup in the config.

This information will be found in the status screen, in the System Status window.

- Basic on / off purge

Purge State	Time	Purge Suct Temp	Purge Target	Exhaust Pump	24hr Exhaust Time(Min.)	Min. since Last Purge
SWITCHED OFF	00:00:15	25.0F	18.0F	OFF	4	0

- Carbon regen purge

Purge State	Time	Purge Suct Temp	Purge Target	Exhaust Pump	24hr Exhaust Time(Min.)	Min. since Last Purge	Carbon Tank Remain %	Carbon Temp
REGEN HI TEMP	00:00:55	25.0F	18.0F	OFF	4	0	0	87.0F

Below shows all the possible states the purge can be in. Do note that depending on the purge type all states may not be used.

- 0 SWITCHED OFF
- 1 FLOAT FAULT
- 2 M-PRG OFF
- 3 M-PRG RUNNING
- 4 A-PRG OFF
- 5 A-PRG RUNNING
- 6 FAULT EXS TIME
- 7 ADAPTIVE OFF
- 8 ADAPTIVE ON
- 9 REGEN HEATING
- 10 REGEN COOL DWN
- 11 REGEN HI TEMP

15.2.4 Trane CVHE, CVHF and CVHG Earthwise Chillers

A MCS temperature sensor (converted) is installed through the top of the carbon tank shell so that MCS controls can monitor the carbon bed temperature. The temperature sensor controls the regeneration cycle and protect against overheating. If the limit temperature is reached, the system shuts down and a Purge Carbon Regen Temperature Limit Exceeded diagnostic is generated. Below is how the SERVICE FIRST SENSOR PART #SENO1960 is converted to be used with the MCS MAGNUM.

15.2.4.1. MCS TRANE-CARBON PROBE SENSOR CONVERSION

The original ServiceFirst sensor supplied with the Trane Earthwise chiller is converted by removing the circuit board from the end of the cable as shown below and is wired to the MAGNUM three pin connector..

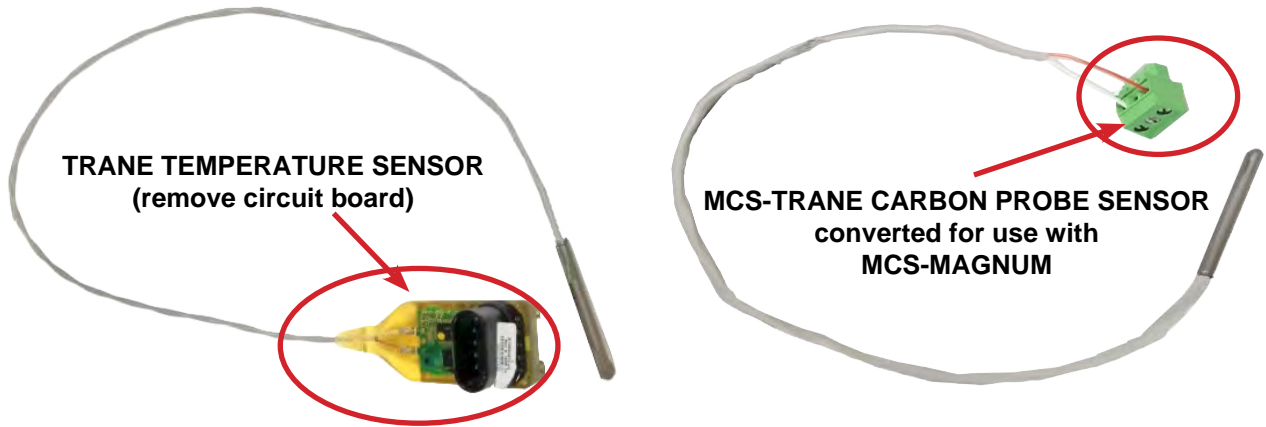

The MCS Temperature sensor is wired to the Magnum +5 and S1 terminals with the **jumper on Analog position**.

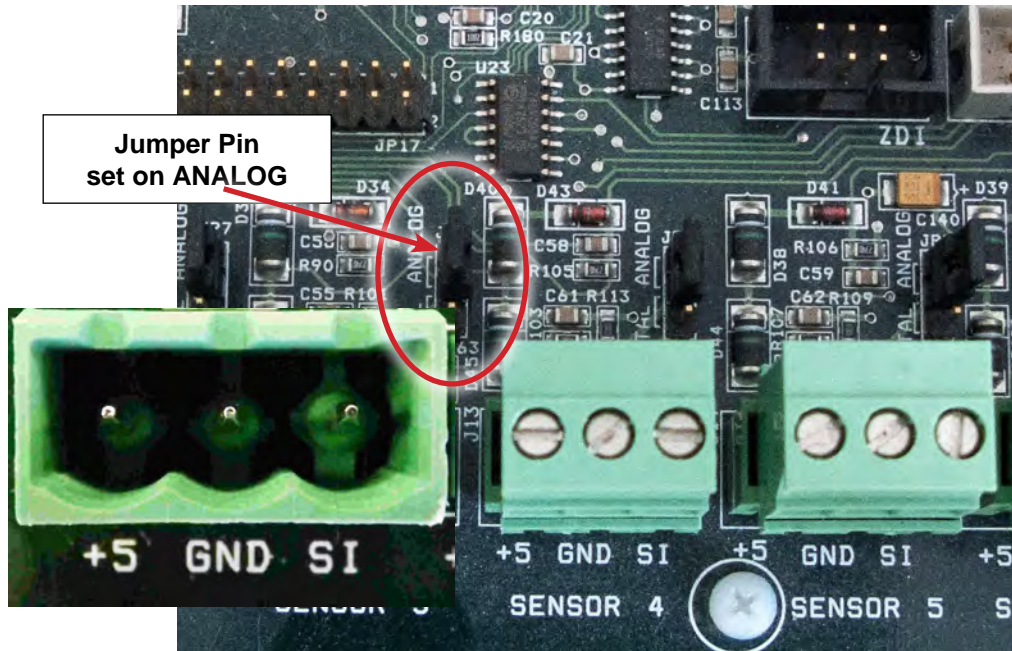

Chapter - 16. Standard Controls

16.1. Custom Rotation

The requirement is to enable rotation only in the first barrel and do not turn ON any compressors associated with the second barrel until all compressors are ON in the first barrel. When decreasing refrigerant capacity, if any compressors in the second barrel are ON, they must first be turned OFF before turning OFF any compressors in the first barrel. Only first ON and first OFF lead rotation strategy can be used.

To activate this option Setpoint #103 "LEAD COMP" must be set up as follows:

Value:	0 (indicates auto rotation, must be 0)
Time (SEC):	0 (indicates first on first off, must be 0)
Select Value:	DIGITAL/SW
Type of Setpoint:	Target (must be Target type)
High Zone:	1 (this is the starting compressor following a reset; usually 1)
Low Zone:	1 (number to rotate, will default to 1)
Night Setback:	8 (number of compressors in the first barrel)

If the Value, Time, and Type cells are not set as indicated, normal rotation using Setpoints #103 "LEAD COMP" and #104 "COMP ROTATION" will be used.

The following examples have 16 compressors, dual barrels with 8 compressors in each. Barrel 1 has compressors 1 through 8 and 9 through 16 are in barrel 2. The wanted/actual ON will function as usual only the rotation and the sequence of turning on the compressors have been changed.

Example 1: Compressor 1 is the lead capacity calls for 4 circuits to be ON (wanted 4/ actual 4), then reduced to 0/0.

Compressors 1, 2, and 3, then 4 will be turned ON. As capacity is reduced, Compressor 1 will be turned OFF and the lead will be rotated to Compressor 2. Then Compressors 2, 3, and 4 will be turned OFF with the lead ending with Compressor 5.

Example 2: Compressor 5 is now the lead and capacity calls for 6 compressors to be ON (6/6) then reduce to 0/0.

Compressors 5, 6, 7, and 8, then 1 and 2 will be turned ON (6/6). As capacity is reduced, Compressors 5, 6, 7, and 8, then 1 and 2 will be turned OFF (0/0) and Compressor 3 will be the lead. Note, compressors in barrel 2 were not turned ON.

Example 3: Compressor 3 is now the lead and capacity calls for 12 compressors to be ON (12/12) then reduce to 0/0.

Compressors 3, 4, 5, 6, 7, and 8, then 1 and 2 will be turned ON (8/8). At this point all compressors in barrel 1 are ON, as more capacity is needed Compressors 9 through 16 will be used. Compressors 9, 10, 11, and 12 will be turned ON to reach 12/12. As capacity is reduced, Compressors 9 then 10, 11, and 12 will be turned OFF (8/8) at this point. Now, all compressors in barrel 2 are OFF and all compressors in barrel 1 can now be turned OFF if less capacity is needed. Compressor 3 followed by 4, 5, 6, 7, 8, and 1 then 2 will be turned OFF (0/0). At this point Compressor 3 is the lead compressor.

16.2. Compressor Anti-Cycle Logic

When a compressor is to be turned off, the Magnum software will make a calculation to determine the amount of time that the compressor will remain in an anti-cycle state. This calculation is based upon how long the compressor has been on and Setpoints #59 "ACYC OFF->ON" and #63 "ACYC ON->ON".

- Adaptive mode a 50K ¼ watt resistor is wired thru a dry set of contacts between +5vdc and S1 terminals on the sensor input. When the dry contacts are closed this will apply approximately 3.75vdc to S1 terminal.

If the value of Setpoint #63 minus the amount of time that the compressor has been on is greater than the value in Setpoint #59, the compressor will remain in the anti-cycle state for the period of time specified in Setpoint #63. Else the anti-cycle timer will be set to the value in Setpoint #59.

For example:

#59 (ANTI-CYC OFF) = 300 seconds

#63 (ANTI-CYC ON) = 600 seconds

If the compressor had been running for 3 minutes (180 seconds)

$600 - 180 = 420$ this is greater than Setpoint #59; therefore, the anti-cycle timer will be set to 600 seconds, the value of Setpoint #63.

If the compressor had been running for 12 minutes (720 seconds)

$600 - 720 = -120$ this is less than Setpoint #59; therefore, the anti-cycle timer will be set to 300 seconds, the value of Setpoint #59.

If the controller loses power, the length of time that the system was down will be taken into consideration when determining whether the compressor should be in an anti-cycle state and for how long.

16.3. Part Wind and Star Delta Starters

Both Part Winding and Star Delta starter types are supported by the Magnum software. This option is specified in the 'Part Winding' cell of the Circuit Base screen in MCS-Config and will require two successive Relay Output points. When this option is selected, make Setpoint #73 "STARTER DLAY" active. This Setpoint contains the delay in seconds or transition percentage before the second Relay Output is turned on. This delay is normally 1 second for part winding or 5 seconds for a star delta starter. If using the transition percentage option, after initial startup amp spike, the amps must fall below this percentage of the FLA for the second step to be turned on.



73	STARTER DLAY	<p>This Setpoint controls the start of a compressor's second relay.</p> <p>If the 'Select Value: # decimals & print char' cell is set to 'HUMD or %' then logic is: If First Compressor Relay has been on longer than 2 seconds and the FLA% goes below the value of this setpoint or is still above the value but reaches the time value in the safety time field than turn on the second relay. (If the low zone field is zero use the hardcoded 2 seconds delay at start. If greater than zero use that value).</p> <p>Setpoint Information Screen, if the 'Select Value: # decimals & print char' cell is set to 'Seconds' then the Setpoints value is a time delay between the first and second relay's start. Used for part wind (typical value of 1) and star delta (typical value of 5) starter.</p>
----	--------------	---

16.4. Full Load Amp (FLA) calculation and slide positioning

For variable capacity compressors the Magnum will calculate a FLA for each compressor and it will be stored in the FLA Setpoints (#171 to #190) for compressors 1 through 20 with every pass of the algorithm. The calculated FLA value will be displayed when viewing the respective compressor Setpoint through the Keypad/Display or MCS-Connect. The calculation is based upon the slide multiplier, divisor and offset values and then adjusted for the difference between the actual and design pressures for suction and discharge. This calculation is then used to determine the slide position by taking the actual amp draw divided the calculated FLA value. The load and unload solenoids will be used to match the compressor slide position with the wanted FLA.

If a FLA Setpoint is changed from MCS Connect both the original and calculated values are displayed in the following screen:

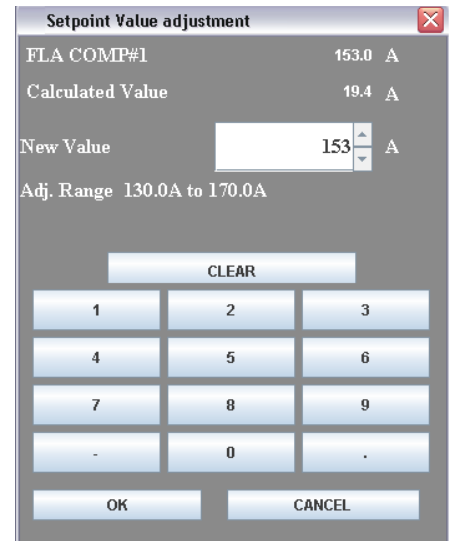

16.5. Chiller Barrel Heater

If a Chiller Barrel Heater is specified, it will be controlled based upon ambient temperature and Setpoint #134 "BARREL HEATER".

16.6. Hot Gas Bypass

Control of the Hot Gas Bypass function will depend on which Setpoints are made active/inactive. Refer to section 13 Setpoints #4-#7.

- **Setpoints #4-#7 INACTIVE**—If Setpoints #4-#7 are all inactive, then the HGB is enabled when the machine is unloaded to within 25% of the minimum slide percentage. The HGB is disabled when the machine rises above 30% of the minimum slide percentage. (These are just default values that can be overridden in the "Time(sec)" fields of Setpoints #4 and #5. The "Time(sec)" field of Setpoint #4 contains the minimum slide percentage offset to enable the HGB; the "Time(sec)" field of Setpoint #5 contains the minimum slide percentage offset to disable the HGB. For example, if Setpoint #4 "Time(sec)" field has a value of 10 and Setpoint #5's is 15, then the HGB will enable when the compressors FLA% is within 10% of Setpoint #31 "MIN FLA%" and will disable when FLA% goes above 15%.)

- **Only Setpoints #4-#5 ACTIVE**—The HGB is on when the machine is unloaded and the leaving liquid goes below the Cut In (Setpoint #4 "HGS TEMP ON"). HGB is turned off when the leaving liquid temperature goes above the Cut Out (Setpoint #5 "HGS TEMP OFF") or the machine leaves the unloaded state.

- **Only Setpoints #6-#7 ACTIVE**—The HGB is on when the machine is unloaded and the suction pressure goes below the Cut In (Setpoint #6 "HGS PSI ON"). HGB is turned off when the suction pressure goes above the Cut Out (Setpoint #7 "HGS PSI OFF") or the machine leaves the unloaded state.

- **Setpoints #4-#7 ACTIVE**—If both groups of Setpoints are active, then the HGB is on when the machine is unloaded and either the leaving liquid temperature or the suction pressure goes below the respective Cut In limit. The HGB goes off when the machine leaves the unloaded state or both the leaving liquid temperature and the suction pressure goes above the respective Cut Out limits.

16.7. Chilled Water Reset

Chilled Water Reset (CWR) is a 0 to 5 volts dc Sensor Input (Display Type is TRGTRST) to the MCS microprocessor. The CWR follows the following rules using Setpoint #21 "MAX TRG RESET":

1. If the input is 2.5 volts dc the CWR is zero.
2. At 0 vdc the CWR is a negative value equal to the Setpoint value.
3. At 5 vdc the CWR is a positive value equal to the value in the Setpoint.
4. For values in between 0 – 2.5 and 2.5 – 5.0 the CWR is a plus or minus value which is proportional to the Sensor Input voltage.

16.8. Oil Equalization Option

Oil equalization occurs with common suction/discharge systems. This feature allows for oil to equalize between compressors by opening a solenoid valve. The oil equalization occurs at compressor startup. Refer to section 12 for Relay Output order and options. If this feature is specified in the Circuit Base screen, the micro will energize the Oil Equalization solenoid valve for 1 minute at compressor startup.

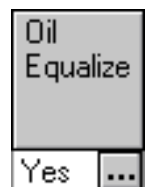

16.9. Liquid Injection Option

This option is specified in the Circuit Base screen:

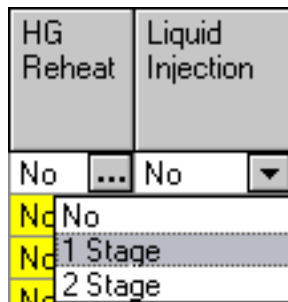

In the Liquid Injection column there is a dropdown menu for each compressor, giving options of No Liquid Injection, 1 Stage, or 2 Stage. If 2 Stage option is selected, the second stage relay must follow the list of available options, it may not necessarily follow the first stage relay. Refer to section 12 for Relay Output order and options.

The first stage will be turned on if either the discharge temperature is greater than Setpoint #8 or suction pressure is less than Setpoint #80 plus 5 psi (.5 Bar). If 2 Stage, the second relay will be turned on if the discharge temperature is greater than Setpoint #8 plus 5.0° F (2.5° C) and the first relay has been on for a time greater than the 'Time (sec)' field of this Setpoint. If the Slide Multiplier cell of the Relay Output for the first stage of liquid injection is non-zero, then this relay will be turned on during the fast unload logic.

16.10. Oil Cooler Option

The oil cooler option can be enabled for compressors with oil. This feature requires an oil seal temperature sensor, a Relay Output to energize the oil cooler, and Setpoint #145 "OIL COOLER ON" to be active. If the oil seal temperature is above Setpoint #145 for longer than the time specified, the oil cooler is energized until the temperature is 5° F below the Setpoint value. Refer to section 12 for Relay Output order and options.

16.11. Oil Pump Control Option

The Magnum supports 3 different types of oil pump control. This option is selected in the 'Control of Oil Pump' box in the 'Compressor Information' panel under the MAGNUM screen.

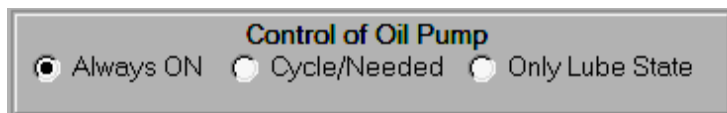

- **OIL PUMP ALWAYS ON** – The oil pump will start before the compressor to build up oil pressure and will always be on when the associated compressor is on. If the oil pressure drops below Setpoint #74 "OIL PUMP OFF", then shut down the associated compressor and generate a LOW DIFFERENTIAL alarm. The oil pump will continue running after the compressor is turned off regardless of the reason, for the time specified in Setpoint #62 "PUMP DOWN DELAY".
- **OIL PUMP CYCLES AS NEEDED** – After the compressor has been running for 2 minutes and when the differential pressure (discharge pressure minus suction pressure) is greater than Setpoint #74 "OIL PUMP OFF", then the oil pump will be turned off. If the differential pressure drops 10 PSI below the value of Setpoint #74, then the oil pump will be turned on again.
- **OIL PUMP LUBE ONLY** – After the compressor has been running for 2 minutes and when the differential pressure (discharge pressure minus the suction pressure) is greater than Setpoint #74 "OIL PUMP OFF", then the oil pump will be turned off. If the differential pressure has not reached Setpoint #74 after 5 minutes, then shut down the associated compressor and generate a LOW DIFFERENTIAL alarm. If the differential pressure has been reached and the oil pump turned off, then if the differential pressure drops 5 psi below the value of Setpoint #74, shut down the associated compressor and generate a LOW DIFFERENTIAL alarm.

16.12. Oil Differential Calculation

For chillers with external oil pumps: Oil Differential = Oil Pressure–Discharge Pressure

For all others: Oil Differential = Oil Pressure–Suction Pressure

If an oil pressure sensor is not available, then discharge pressure can be used in place of it. This is set up in the Circuit SI screen of MCS-Config by selecting the discharge pressure sensor in the oil pressure sensor's column.

16.13. On/Off Switches

The following digital inputs can affect the entire package or individual circuits:

- Flow switch – If OFF the system has no flow. The system will Lockout (if Setpoint #105 is active), or shut down (if Setpoint #105 is inactive).
- Pump down – If ON and the compressor is off, the compressor will not be allowed to start. If the compressor is on, the system moves to the Pump Down state to begin turning off the compressor(s) in normal steps.
- Run/Stop – If OFF the system will not run. If the system is running, the system turns all compressors off in normal steps (If a RUN/STOP and a Network RUN/STOP are both available they operate in series).
- Network Run/Stop – If OFF the system will not run. This input is provided by another system on the network. It functions in the same matter as the Run/Stop switch.
- Emergency Stop – If ON the system will be shut down immediately and will remain disabled until the switch is OFF.

16.14. Low Suction Unloading and Holding

This option is activated when Setpoint #78 “LO SUCT UNLD” is active. When suction pressure is below the calculated value of Setpoint #77 “LOW SUCTION” plus Setpoint #78 “LO SUCT UNLD” for the time specified in the ‘Time (sec)’ field, the Magnum will turn on the WARNING Relay Output if specified in MCS-Config and take the following action:

- For fixed step compressors: The Magnum will turn off one step of capacity of the compressor(s) with low suction until all steps except one are unloaded. The circuit state will be LO SUCT HOLD. The compressor will remain in this state until the capacity control indicates that another step is to be unloaded or if the suction pressure has returned to normal after the time in Setpoint #101 “SAFETY HOLD DELAY” has passed.
- For variable step compressors: The Magnum will begin unloading the compressor(s) with low suction until the suction pressure rises above the calculated value. During this time the circuit state is LO SUCT UNLOAD. Once this pressure has been reached, the circuit state will be LO SUCT HOLD. The compressor will remain in this state until the capacity control indicates that another step is to be unloaded or if the suction pressure has returned to normal after the time in Setpoint #101 “SAFETY HOLD DELAY” has passed.

Normal suction pressure is defined as any value greater than Setpoint #77 “LOW SUCTION” plus Setpoint #79 “LO SUCT RELD”. Refer to Setpoints #78 and #79 for additional information.

16.15. High Discharge Pressure Unloading and Holding

This option is activated when the Setpoint #82 “HI DISC UNLD” is active. When the discharge pressure is above the calculated value of Setpoint #81 “HI DISC PSI” minus Setpoint #82 “HI DISC UNLD” for the time specified in the ‘Time (sec)’ field, the Magnum will turn on the WARNING Relay Output if specified in MCS-Config and take the following action:

- For fixed step compressors: The Magnum will turn off one step of capacity of the compressor(s) with high discharge until all steps except one are unloaded. The circuit state will be HI DISC HOLD. The compressor will remain in this state until the capacity control indicates that another step is to be unloaded or if the discharge pressure has returned to normal after the time in Setpoint #101 “SAFETY HOLD DELAY” has passed.

- For variable step compressors: The Magnum will begin unloading the compressor(s) with high discharge until the discharge pressure drops below the calculated value. During this time the circuit state is HI DISC UNLOAD. Once this pressure has been reached, the circuit state will be HI DISC HOLD. The compressor will remain in this state until the capacity control indicates that another step is to be unloaded or if the discharge pressure has returned to normal after the time in Setpoint #101 "SAFETY HOLD DELAY" has passed.

Normal discharge pressure is defined as any value less than the calculated value of Setpoint #81 "HI DISC PSI" minus Setpoint #83 "HI DISC RELD" and greater than Setpoint #85 "LO DISC PSI". Refer to Setpoints #82 and #83 for additional information.

16.16. High Discharge Temperature Unloading and Holding

This option is activated when the Setpoint #88 "DISC TMP UNLD" is active. When the discharge temperature is above the calculated value of Setpoint #87 "HI DISC TMP" minus Setpoint #88 "DISC TMP UNLD" for the time specified in the 'Time (sec)' field, the Magnum will turn on the WARNING Relay Output if specified in MCS-Config and take the following action:

- For fixed step compressors: The Magnum will turn off one step of capacity of the compressor(s) with high discharge temperature until all steps except one are unloaded. The circuit state will be HI DISC HOLD. The compressor will remain in this state until the capacity control indicates that another step is to be unloaded or if the discharge temperature has returned to normal after the time in Setpoint #101 "SAFETY HOLD DELAY" has passed.
- For variable step compressors: The Magnum will begin unloading the compressor(s) with high discharge temperature until the temperature drops below the calculated value. During this time the circuit state is HI DISC UNLOAD. Once this temperature has been reached, the circuit state will be HI DISC HOLD. The compressor will remain in that state until the capacity control indicates that less capacity is needed or if the discharge temperature has returned to normal after the time in Setpoint #101 "SAFETY HOLD DELAY" has passed.

Normal pressure is defined as any value less than the calculated value of Setpoint #87 "HI DISC TMP" minus Setpoint #89 "HI DISC RELD". Refer to Setpoints #88 and #89 for additional information.

16.17. High Ampere Unloading and Holding

This option is activated when the Setpoint #75 "HI AMPS %" is active. Note: This option can only be active for fixed step compressors. When the amp draw is within one-half of the calculated HI AMP safety value, the Magnum will turn on the WARNING Relay Output if specified in MCS-Config and take the following action:

- For fixed step compressors: the Magnum will turn off one step of capacity associated with that compressor until that compressor is in an UNLOADED state that is all steps except one are unloaded. The circuit state will be HI AMP HOLD. The compressor will remain in that state until the capacity control indicates that another step is to be unloaded or if the amp draw has returned to normal after the time in Setpoint #101 "SAFETY HOLD DELAY" has passed.

16.18. Low Water Temperature Unloading and Holding

When the leaving liquid temperature is within 1.5° F (.8° C) of the freeze safety, the Magnum will turn on the WARNING Relay Output if specified in MCS-Config and take the following action:

- For fixed step compressors: The Magnum will turn off one step of capacity of the compressor(s) with low water temperature until all steps except one are unloaded. The circuit state will be LO TMP HOLD. The compressor will remain in that state until the capacity control indicates that another step is to be unloaded or if after 5 minutes the leaving liquid temperature has turned to normal.
- For variable step compressors: The Magnum will begin unloading the compressor(s) with low water temperature until the leaving liquid temperature rises above the calculated value. During this time the circuit state is LO TMP UNLOAD. Once the leaving liquid temperature rises above the calculated temperature the circuit state will change to LO TMP HOLD. The compressor will remain in that state until the capacity control indicates that less capacity is needed or if after 5 minutes the leaving liquid temperature

has turned to normal.

Normal leaving liquid temperature is defined as any value more than 3.0F (1.6C) above the freeze safety trip value.

16.19. Energy Efficient Compressor Staging

In a multi-screw system, it may be more efficient to run the screws at less than 100% capacity until all compressors have been turned on.

The following Setpoints are used to control the screw compressor staging:

- Setpoint #30 “MAX SLIDE %” contains the maximum slide percentage, based upon amp draw, before the system will bring on the next compressor.
- Setpoint #31 “MIN SLIDE %” contains the minimum slide percentage, based upon amp draw, before the system will reduce the number of compressors wanted on.

For example if “MAX SLIDE %” is 80% and the “MIN SLIDE %” is 40%, the two-screw compressor system would be ramped up as follows:

The Lead compressor will be started at 40% and increased up to 80%. If more capacity is needed the next compressor will be started at 40% and the first compressor decreased to 40%. The two compressors will then have their slide positions changed together. Since there are only two compressors, they will be ramped together up to 100% if required. If both compressors are at 40% and less capacity is needed, one compressor will be turned off and the other increased to 80%.

If running compressors at 100% is not desired, then the “Last Stage to 100% (Override Setpoint)” cell in the Compressor Information panel of the MAGNUM screen should be set to ‘No’. Then the maximum capacity allowed will be the value in Setpoint #30. If ‘Yes’, then all compressors will load to the value in Setpoint #30 until all compressors are on, then they will load to 100% together.

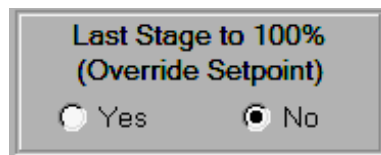

16.20. Chilled Water Pump Control

The current Magnum software will support a chilled water pump plus a backup with rotation logic. These must be set up in MCS-Config. **Setpoint #105** and **Setpoint #106** are used with this control logic.

- If **Setpoint #105** “PUMP FAILURE” is **active**, flow is lost for the period of time contained in the ‘Time (sec)’ field, and only one pump is present, then the system will move to a LOCKED OUT state. If the system has two pumps and flow is lost, then the backup pump will start and the lead pump will be locked out. A Lockout Reset will be required to restart the system or to reactive a locked out pump.
- If **Setpoint #105** is **inactive** and the flow is lost, the system will move to the OFF- NO EVAP FLOW state. When flow is returned the system will automatically restart, no reset is required.

Setpoint #106 “LEAD PUMP” indicates whether the rotation option is active or which pump is the lead pump.

- If Setpoint #106 is zero, then rotation of the pumps will occur whenever the lead pump is turned off. If no rotation has occurred during the current day, a forced rotation at midnight will occur. This forces at least one rotation per day.
- If **Setpoint #106** is non-zero, then rotation of the pumps is inactive and the value will specify the lead pump. This Setpoint can be changed in a live unit and the appropriate action will be taken.

16.20.1 Special Rotation for Chiller Pump Rotation

This feature is designed to rotate the chiller pumps at midnight with a minimum disruption to the flow.

- **Setpoint #238** must be active and contain the following information:

Type: Delay

Value: Not used

Safety time: delay between states

- **Set point #106** must be active and contain the following information:

Type: Set point

Value: Number of days between rotation

At mid-night when rotation is required both chiller pumps will be on for the time in the safety time cell of set point #238. Once this time has elapsed, the current lead chiller pump will be turned off and the lead switched to the other chiller pump.

Prior to rotation the system will verify that the next chiller pump is available. That chiller pump's status must be AUTO and if a fault is specified it must be off or the rotation will not be made. Rotation is only checked a mid-night. If the lead pump fails; normal rotation will occur to the next chiller pump.

16.20.2 Special Rotation For Process Pumps Rotation.

This feature is designed to rotate the process pumps at mid night with a minimum disruption to the flow.

Set point #239 must be active and contain the following information:

Select Value: HUMD or%

Type: Delay

Value: VFD setting of lead process pump during State 1

Safety time: delay between states 3o

MIN VFD Opening: setting of lead process pump during State 2 2.0

MAX VFD Opening: setting of next process pump during State 2 5.;

Set point #197 must be active and contain the following information:

Type: Set point

Value: Number of days between rotation 0

At mid-night when rotation is required the lead process pump's VFD will be set to Value of set point #239, this is state 1, the next process pump is off. The process pumps will be in state 1 for the time in the safety time cell of set point #239.

Once this time has elapsed, the current lead process pump's VFD will be set to the value in MIN VFD of set point #239 and the next process pump will be turned on and its VFD will be set to the value in MAX VFD of set point #239, this is state 2. The process pumps will be in state 2 for the time in the safety time cell of set point #239.

Once this time has elapsed, the current lead process pump's VFD will be set to 0 and the process pump turned off. The lead will be switched to the next process pump and normal process pump control will continue.

Prior to rotation the system will verify that the next process pump is available. That process pump's status must be AUTO and if a fault is specified it must be off or the rotation will not be made. Rotation is only checked a mid-night. If the lead process pump fails; normal rotation will occur.

16.21. Process Pump (Heat Exchanger) Control

The Magnum software can support either variable or fixed stages of heat exchangers with up to two process pumps with rotation and control based upon pressure or temperature. This option is specified in the Evaporator Information panel in the MAG screen.

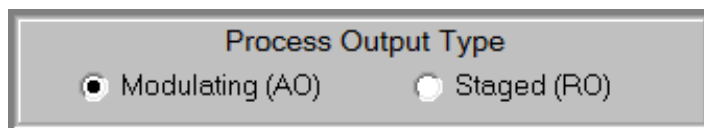

The pump information must be set up in the Evaporator Information Panel under the MAGNUM screen. The following information is required for each pump if used:

Pump Relay Output

Pump VFD Analog Output (if used)

VFD fault (if used)

Pressure Sensor Input (if used)

Pressure sensor output (if used)

Process temperature (if temperature control)

The following Setpoints are required:

- #146 "PROC TARGET"
- #147 "PROC ZONE"
- #148 "PROC DELAY"
- #149 "PROC MAX ROC"
- #150 "Proc Minutespd%"
- #197 "LEAD ProcPmp"
- #198 "PROC PUMP FLT"

See Section on Setpoints for descriptions.

The process pump is on whenever the chilled water pump is on.

16.22. Control Power Relay (No Stop)

This feature provides the capability to interrupt the power supply to the system when a particular compressor continues to draw a specified amperage level when it is called to be OFF. A Relay Output, referred to as the control relay, must be wired so that no power reaches the compressors when it is switched OFF. The Relay Output must be selected in the 'Control Relay' cell of the General Information panel of MCS-Config and Setpoint #112 "NO STOP" must be active. The Magnum will continually monitor the amp draw of compressors that are called to be OFF. If the amp draw is greater than the FLA for that compressor multiplied by the percentage in Setpoint #112 "NO STOP" for the time specified in the 'Time (sec)' field, then the control relay will turn OFF, a NO STOP alarm will be generated, and the system will be Locked Out.

16.23. Low and High Ambient Shutdown

The Magnum software supports both low and high ambient temperature shut downs. This option requires an ambient temperature sensor and one or both of Setpoints #24 "LOW AMB OFF" and #26 "HIGH AMB OFF". The AMBIENT OFF state is entered when the ambient temperature falls below the Setpoint #24 or above Setpoint #26. The system will remain in this state until the ambient temperature rises 5.0F (2.5C) above Setpoint #24 value or drops 5.0F (2.5C) below Setpoint #25. When the chiller is in this state, the individual compressor states are changed to the CMP IS OFF state through the normal staging function.

16.24. Imperial, Metric, and Combined Unit sensor readings

The Magnum software supports Imperial, Metric, and Combined unit sensor readings. This setting is specified in the Setup screen of MCS-Config. All sensor values and all software-coded offsets are automatically converted to the option selected and displayed with the appropriate character. The following table contains the display character:

SENSOR READING	ENGLISH CHARACTER	METRIC CHARACTER	MIXED CHARACTER
Temperature	F	C	C
Pressure – Gage Reading	P	B	P
Pressure – Absolute Reading	p	b	p
Humidity	%	%	%
Digital or Switch			
Amp or CT	A	A	A
Voltage	V	V	V
Refrigeration Level	%	%	%

If the unit type is changed, MCS-Config will give you an option to automatically change the values of all items in the Setpoints to match the new type and will automatically adjust the display characters.

16.25. Warning and Alarm Relay Outputs

The Warning Relay Output will be turned on whenever the Magnum generates a warning message. These messages are:

- LOW REFR TEMP UNLOAD
- LOW SUCT PSI UNLOAD
- HIGH DISC TEMP UNLOAD
- LOW SUCT RELOAD
- LOW DISC RELOAD
- CIRCUIT IS IN A SAFETY STATE

The system will continue to run since no safeties have tripped. The Warning Relay Output will also be turned on whenever a compressor is placed in a safety state.

The Alarm Relay Output will be turned on whenever the Magnum generates an alarm message. This indicates that a safety trip or Lockout has occurred.

16.26. Vi Port Control Logic (Open Drive Screw only)

The internal volume (Vi) of the open drive screw can be dynamically adjusted to achieve maximum efficiency modulating the Vi control solenoids. The duration of each solenoid pulse is contained in Setpoint #114 "Vi PULSE".

The ratio of discharge pressure divided by suction pressure is calculated. This ratio is blocked between 50 and 22. The value of Setpoint #115 "Vi DEADBAND" is added to and subtracted from this ratio to develop a control zone. The control zone will be recalculated based upon the time in Setpoint #116 "Vi DELAY". Refer to Setpoints #117, #118 and #119. The system will pulse the solenoids to keep the Vi reading within the calculated control zone.

16.27. Operating Schedules

Two operating schedules per each day of the week and 8 holidays are supported by the Magnum software. Each schedule contains a start and end time. If the time and day of the Magnum clock is within these limits then the schedule is true and the system will be allowed to run. If not, the system will be off due to schedule.

16.28. Mod-Motor Limit Control for Flooded Chiller

This option was added for Dunham-Bush flooded chillers. The Mod-Motor is a self-contained device that modulates a flooded chiller barrel level control valve based on a level sensor. The Magnum controls two Relay Outputs that change the limits on the movement of the Mod-Motor (The Relay Outputs change resistance to an input on the Mod-Motor). These Relay Outputs must be placed consecutively and specified in the General Information panel under the MAGNUM screen of MCS-Config.

- When one or less compressors are on, the first Mod-Motor Relay Output is turned on and the second Mod-Motor Relay Output is off.
- When 2 or more compressors are on, the first Mod-Motor Relay Output is turned off.
- The second Mod-Motor Relay Output will be turned on if the suction pressure is greater than 85.0 psi (5.8 bar) and the discharge suction pressure differential is less than 30.0 psi (2.0 bar), and the second Mod-Motor Relay Output will stay on as long as the suction pressure is greater than 80.0 psi (5.8 bar) and the discharge suction pressure differential is less than 35.0 psi (2.4 bar). If neither of the above is true, then the second Mod-Motor Relay Output will be turned off.

16.29. Hot Gas Reheat (Humidity) Control

The Hot Gas Reheat Control option is activated by selecting Yes in the 'HGReheat' cell in the Circuit Base Screen.

The hot gas control sensor is specified in the Evaporator Information panel of the MAGNUM screen. Select the input sensor that will be used to control the hot gas reheat function in the 'Reheat Control' cell.



Evaporator Information

Capacity Control

Control Method
 Cut In/Out Control Zone

Control Temperature On
 Entering Tmp Leaving Tmp

Entering Temperature: WTR IN
 Leaving Temperature: WTR OUT

Target Reset:
 Ice Mode: DI On/Off Normal: AI:0-5V

Target (SP #1) Reset: NetRun/Stp
 Refrigerant Type: R407C

Evaporator Tonnage: UNIT TONS

Pump/Fan

Pump/Fan #1A: Not Used Pump/Fan #1B: Not Used
 Pump/Fan #2A: Not Used Pump/Fan #2B: Not Used

Flow Switch A: WATER FLOW Flow Switch B: Not Used

Process Control

Process Output Type
 Modulating (AO) Staged (RO)

Process Control Type
 VFD (0V-10V) ByPass Valve(10V-0V)

Process Pump Relay #1: CHW PUMP 1 Process Pump Relay #2: CHW PUMP 2
 VFD Speed AO #1: BLD PUMP1% VFD Speed AO #2: BLD PUMP2%
 Pressure SI IN #1: PmpPsi IN Pressure SI IN #2: PmpPsi IN
 Pressure SI OUT #1: PmpPsiOUT Pressure SI OUT #2: PmpPsiOUT
 VFD Fault #1: Pmp1VfdFlt VFD Fault #2: Pmp2VfdFlt

Subcooler Valve Control

Type of Subcooler Valve in Use
 None AO(Open When Off)
 RO Type AO(Closed When Off)

Circuit Valve/Pump Control

Force One Always On?
 Yes No

Heat Control

Defrost Type: Reverse Cycle
 Barrel Heater Relay: Not Used

Reheat Control: REHEAT TMP

Economizer/Fluid Cooler

Economizer AO: Not Used

EXV Control

Control By The Lowest Superheat In The Suction Group
 Yes No

When this option is selected the Reheat Relay Outputs must be setup as follows:

Relay Output Information Screen						
# w/ HELP Button	Name	Slide Multiple	Slide Division	Slide Offset	Design Suction Pressure	
1-1	COMP	-----	-----	-----	-----	
1-2	LOAD	-----	-----	-----	-----	
1-3	UNLOAD	-----	-----	-----	-----	
1-4	LLS	-----	-----	-----	-----	
1-5	LIQ INJ	-----	-----	-----	-----	
1-6	REHEAT	-----	-----	-----	-----	
1-7	R-Hvalve	-----	-----	-----	-----	
1-8	R-Hbleed	-----	-----	-----	-----	

These Hot Gas Reheat relays are required and they must be placed in the proper sequence to work correctly. The following Setpoints must be active: #129 "RH CUTIN", #130 "RH CUTOUT ADJ", #131 "RH START DLY", #132 "RH BLEED DLY", #133 "RH STAGE DLY".(see Section full Setpoint descriptions).

Hot Gas Reheat sequence of operations:

(The names in the above example will be used to indicate the status of the relays: 1-6 REHEAT, 1-7 R-Hvalve, and 1-8 R-Hbleed)

Condition	1-6 REHEAT	1-7 R-Hvalve	1-8 R-Hbleed
The reheat state is OFF. The compressor is running and the RH TEMP is greater than Setpoint #129 plus #130.	ON	OFF	OFF
The reheat state is STARTING. The compressor is running and the RH TEMP is less than Setpoint #129. It will remain in this state until the time is greater than Setpoint #131, and then will move to the ON state.	ON	ON	ON
The reheat state is ON. The reheat will remain in this state until the reheat temperature is greater than Setpoint #129 plus #130. When the temperature is greater the state will be changed to BLEED.	OFF	ON	ON
The reheat state is BLEED. It will remain in this state until the time is greater than Setpoint #132, it will then move to the OFF state.	ON	OFF	ON

16.30. Extra Liquid Line Solenoid Control

Second and third Liquid Line Solenoids (economizers) are supported and can be used for extra control. To specify, select the Circuit Base Screen:

The third solenoid (economizer) can be controlled either on the slide wanted percentage or as the last step on for that compressor (Refer to section 13 Setpoints #98 and #99). Liquid line solenoids 2 and 3 will be turned on and off as indicated in their Setpoints.

2nd LLS		Economizer		Econo Control	
Yes	...	Yes	...	Slide %	...
No	...	No	...	Slide %	...
No	...	No	...	Slide %	...

16.31. Outside Air Economizer/Fluid Cooler with Analog

16.31.1 Output Control

The purpose of an economizer/fluid cooler is to take advantage of any available free cooling so as to avoid the need of mechanical cooling. Several options can be specified in MCS-Config to accomplish this.

16.31.2 Economizer Set up

The analog valve that will be modulated is selected in the 'Economizer AO' cell in the Evaporator Information panel. In this example the name is 3 WAY VLV.

If the economizer/fluid cooler has separate fans (not associated with condensers) then answer yes in the 'Separate Economizer Fans?' cell. If Yes, then four additional cells will appear: 'Starting Economizer Fan' (select the first fan Relay Output), '# of Econ Fans' (specify the number of fan points), 'Starting Economizer Fault' (select the first fan fault, this is a Sensor Input), and '# of Econ Faults' (specify the number of faults)

In the above example there are two fans and two faults associated with the economizer/fluid cooler. If there is more than one fan they must be consecutive Relay Outputs. The same is true of the condenser faults.

The condenser fans can also be used to assist in the free cooling function when the system is not using mechanical cooling. To set this up in the condenser information grid, select "Fluid Cooler Econo" equals "Yes", else "No" if condenser fans are not used. All types of condensers can be used. The above example has indi-

vidual fans per compressor. Whenever a compressor is running the control of its condenser fans will be based solely on the discharge pressure of that compressor, while the condenser fans of compressors that are not running will be controlled by the economizer function. If the type of condenser is common; if any compressor is on all of the fans will be controlled by the highest discharge pressure and not by the economizer function.

The following Setpoints must be set up: #107 "EcoDelayMech", #115 "EcoVFDfanDely", #119 "EcoOffsetON", #120 "Eco Stg Dely", #121 "Eco MIN VLV%", #122 "Eco MAX VLV%", #123 "Eco MAX ADJ", #124 "EcoVlvAdjDly", #125 "Eco StageDly", #126 "Eco MULTI", and #127 "Eco DIVIDE"

(Refer to section for Setpoint descriptions)

16.31.3 Sequence of Operation

The Economizer logic will be enabled whenever the ambient temperature meets the requirement as stated in Setpoint #119 "EcoOffsetON" (Ambient Temperature < Target Temperature–Setpoint #119). For example if the target is 45.0F and Setpoint #119 is 10.0F, then the ambient temperature must be less than 35.0F to enable the economizer function to begin.

If mechanical cooling has not been enabled (no steps are Wanted On or Actual On), when the economizer starts the Unit State will be ECONOMIZER ONLY. In this state mechanical cooling will not be started until the economizer function has reached its maximum capacity (Economizer valve is at maximum opening, all available fans are turned on, and the control temperature is still not in the target zone).

When the economizer logic starts, the Magnum will modulate the Analog Output to the economizer valve to maintain the control sensor reading within the target zone. The valve will be modulated between Setpoint #121 "Eco MIN VLV%" and Setpoint #122 "Eco MAX VLV%" and will wait the time contained in Setpoint #124 "EcoVlvAdjDly" before making each adjustment to the valve opening.

- If control temperature is above the control target, Setpoints #1, and the control temperature rate of change is greater than the value of Setpoint #27 "MAX ROC-":

This indicates that the control temperature is too high and it is not approaching the target fast enough, therefore the valve opening must be increased if possible. The adjustment value will be the difference between the target (Setpoint #1) and the control sensor temperature multiplied by Setpoint #126 "Eco MULTI" and divided by Setpoint #127 "Eco DIVIDE". If the absolute adjustment is greater than the value of Setpoint #123 "Eco MAX ADJ", then it will be limited to this value. The economizer valve opening will be increase by this value.

- If control temperature is below the economizer control zone (Setpoint #1–Setpoint #3) and the control temperature rate of change is less than the value of Setpoint #28 "MAX ROC+":
- This indicates that the control temperature is too low and it is not approaching the target fast enough, therefore the valve opening must be decreased if possible. The adjustment value will be the difference between the target (Setpoint #1) and the control sensor temperature multiplied by Setpoint #126 "Eco MULTI" and divided by Setpoint #127 "Eco DIVIDE". If the absolute adjustment is greater than the value of Setpoint #123 "Eco MAX ADJ", then it will be limited to this value. The economizer valve opening will be decrease by this value.
- If control temperature is above the bottom of control zone (Setpoint #1–Setpoint #3) but less than the control target (Setpoint #1) no change to the economizer valve opening will be made.

Once the valve has reached its maximum opening (Setpoint #122), the Magnum will wait the time specified in Setpoint #125 "Eco StageDly" before checking if there are any fans associated with the economizer function. If there are the Magnum will stage the fans to maintain the control temperature with in the target zone. If a fan VFD is present, then this will be modulated in the same manner. The delay between VFD adjustments will be the value in Setpoint #115 "EcoVFDfanDely" if active, else Setpoint #124 will be used. Once all fans associated with the economizer function are on, the Magnum will check if any condenser fans can also be used. If yes, then these fans will then be staged to maintain the control temperature.

Once all the fans and/or VFD have been turned on and the control temperature is still greater than the control zone for the time specified in Setpoint #107 "EcoDelayMech" if active (else the time in Setpoint #125 "Eco StageDly" will be used) then mechanical cooling will be enabled.

- If the ambient temperature rises above the offset in Setpoint #119 during economizer cooling mode, then the economizer function will be terminated, its valve opening will be set to zero, and mechanical cooling will be enabled.

- If the control temperature is less than the target temperature (Setpoint #1) minus the 3 times value of Setpoint #3, then the economizer function will be terminated, its valve opening will be set to zero, and all fans will be turned off.
- If during mechanical cooling mode the ambient temperature drops below the offset in Setpoint #119, then the economizer function will begin. Note: the Unit State will not change, the economizer valve will be modulated as described above, fans directly associated with the economizer will be used, and no fans associated with the condensers will be used.
- The control rate of change is always checked before an adjustment to the valve is made. The purpose is to not change the valve opening if the temperature is moving toward the target at an acceptable rate.

16.31.4 Outside Air Supply Economizer

If the purpose of the economizer is to provide outside air, then there will be no fans associated with the economizer and no condenser fans will be used. In this setup the economizer valve opening will never be less than the value of Setpoint #121 "Eco MIN VLV%". This is required to supply the minimum of outside air.

16.31.5 Mechanical Cooling Enabled

Once mechanical cooling has been enabled, the economizer will control only the individual compressor condenser fans of compressors that have not been started. The discharge pressure will control all others.

The percentage of the economizer valve opening will not be decreased. It will remain at its maximum setting until all stages of mechanical cooling are off.

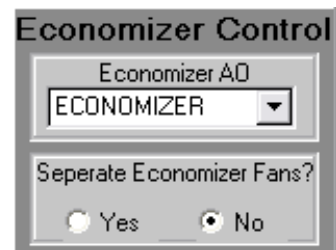

16.31.6 Example: Fluid Cooler with VFD condenser fan

The economizer AO has been selected and there are no separate economizer fans.

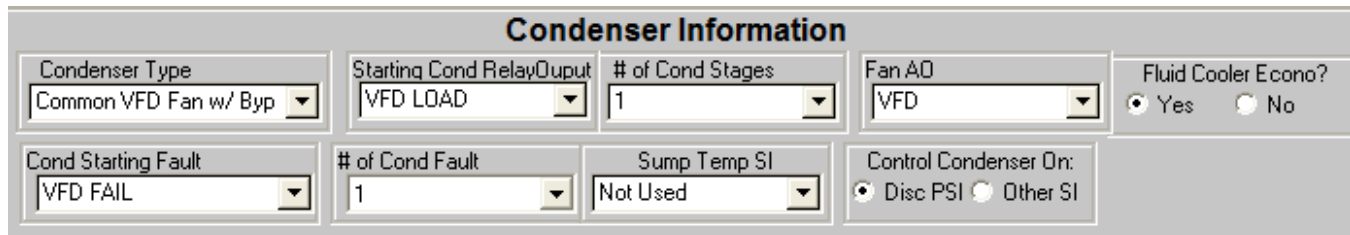

The condenser type is common with VFD control and the Fluid Cooler Economizer option has been enabled. The VFD of the condenser fan will be controlled by the economizer function unless any compressor is running. If a compressor is running the VFD control will be based upon the highest discharge pressure.

Assume the following setup:

Setpoint #	Name	Value
1	SPPLY TRGT	44.0F
2	CTRL ZONE+	2.0F
3	CTRL ZONE-	1.0F
27	MAX ROC-	-.6F
28	MAX ROC+	.6F
54	CND MIN OPEN	20.0%
55	CND MAX OPEN	100.0%
107	ECON-MECHdly	240s
115	EconVFDdelay	45s
119	EcoOffsetON	10.0F
120	EconDelyFans	60s

121	EcoVlvMinVlv	0.0%
122	EcoVlvMaxVlv	100.0%
123	EcoVlvMaxAdj	5.0%
124	EcoVlvDelay	30s
125	EcoVlvMaxDly	120s
126	EcoVlv Mul	3
127	EcoVlv Div	2

Analog output	Name
AO M-1	ECONOMIZER

Conditions when the run/stop was set to RUN

Ambient temperature 30.0F
 Control temperature 48.5F

The ambient temperature is less than 44.0 (Setpoint #1) – 10.0 (Setpoint #119) and no mechanical cooling steps are on; therefore, the Unit state will be ECONOMIZER ONLY and the economizer function will be enabled.

The AO M-1 “3 WAY VLV” will be opened to its minimum valve of 0% (Setpoint #121) and it will be modulated based upon the control temperature and the target (Setpoint #1). The first adjustment will be 48.5 – 44.0 = 4.5. This value will be adjusted by multiplier of 3 (Setpoint #126) and divided by 2 (Setpoint #127) to give an adjusted value of 6.7. This value is blocked; maximum allowed adjustment, by Setpoint #123 to allow an adjustment of 5.0%. The economizer valve opening will be increased by this amount if the temperature control rate of change is greater than the value of Setpoint #27.

The economizer function will wait 30 seconds (Setpoint #124) before determining the next adjustment. If the control temperature is now 47.3F; the following adjustment will be calculated.

$47.3 - 44.0 = 3.3 \times 3 / 2 = 4.9$. Since this is less than 5.0 the valve will be open an additional 4.9% if the temperature control rate of change is greater than the value of Setpoint #27.

Each adjustment will be made after a delay of 30 seconds. If the control temperature is below the control target (Setpoint #1) and above the bottom the control zone (43.0F to 44.0F) there will be no change to valve opening.

If the control temperature drops below the control zone the valve opening will be reduced. For example if the control temperature is 42.6F then the following calculation will be made:

$42.6 - 44.0 = 1.4 \times 3 / 2 = 2.1$. Since this is less than 5.0 the valve opening will be reduced an additional 2.1%.

When the valve reaches its maximum opening of 100.0% (Setpoint #122) the economizer function will use other fans if they are available. In this example there are no fans that are associated only with economizer but the VFD fan can now be used. At time delay of 120 seconds (Setpoint #125) be for the VFD will be modulated. Following this initial delay the VFD will be opened to its minimum opening, Setpoint #54 of 20%.

At this point the unit state is ECONOMIZER ONLY, economizer valve is at 100% and VFD will be modulated between its minimum (Setpoint #54) and it maximum (Setpoint #55). The delay between these adjustments will be 45 seconds (Setpoint #115).

Once the VFD opening is equal to its maximum (Setpoint #55) there will be a delay of 240 seconds (Setpoint #107). At this time the unit state will be changed and mechanical cooling will be enabled.

16.31.7 Example: Fluid Cooler with condenser compressor fans

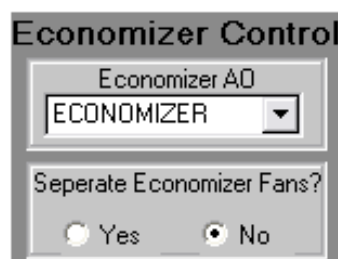

The economizer AO has been selected and there are no separate economizer fans.

Condenser Information

Condenser Type

Fluid Cooler Econo?
 Yes No

Sump Temp SI

Control Condenser On:
 Disc PSI Other SI

The condenser type is RO Step Individual and the Fluid Cooler Economizer option has been enabled. The individual compressor condenser fans will be controlled by the economizer function unless a compressor is running. If a compressor is running, then the condenser fans associated with that compressor will be controlled based upon the discharge pressure of the compressor that is running.

Assume the following setup:

Setpoint #	Name	Value
1	SPPY TRGT	44.0F
2	CTRL ZONE+	2.0F
3	CTRL ZONE-	1.0F
27	MAX ROC-	-.6F
28	MAX ROC+	.6F
107	ECON-MECHdly	240s
115	EconVFDdelay	45s
119	EcoOffsetON	10.0F
120	EconDelyFans	60s
121	EcoVlvMinVlv	10.0%
122	EcoVlvMaxVlv	100.0%
123	EcoVlvMaxAdj	10.0%
124	EcoVlvDelay	30s
125	EcoVlvMaxDly	120s
126	EcoVlv Mul	2
127	EcoVlv Div	1

Analog output	Name
AO M-1	3 WAY VLV
AO M-2	VFD

Conditions when the run/stop was set to RUN

Ambient temperature 30.0F

Control temperature 49.7

The ambient temperature is less than 44.0 (Setpoint #1) – 10.0 (Setpoint #119) and no mechanical cooling steps are on, therefore the Unit state will be ECONOMIZER ONLY and the economizer function will be enabled.

The AO M-1 “ECONOMIZER” will be opened to its minimum valve of 10% (Setpoint #121) and it will be modulated based upon the control temperature and the target (Setpoint #1). The first adjustment will be 49.7 – 44.0 = 5.7. This value will be adjusted by multiplier of 2 (Setpoint #126) and divided by 1 (Setpoint #127) to give an adjusted value of 11.4. This value is blocked by the maximum allowed adjustment (Setpoint #123) to 10.0%. The economizer valve opening will be increased by this amount if the temperature control rate of change is greater than the value of Setpoint #27. With Setpoint #126 equal to 2 and #127 equal to 1, the valve will be adjusted by 2% for every degree difference from the target.

The economizer function will wait 30 seconds (Setpoint #124) before calculating the next adjustment. If the control temperature is now 47.3F the following adjustment will be made.

47.3 – 44.0 = 3.3 x 2 / 1 = 6.6. Since this is less than 10.0 the valve will be open an additional 6.6% if the temperature control rate of change is greater than the value of Setpoint #27.

Each adjustment will be made after a delay of 30 seconds. If the control temperature is below the control target (Setpoint #1) and above the bottom the control zone (43.0F to 44.0F) there will be no change to valve opening.

If the control temperature drops below the control zone the valve opening will be reduced. For example if the control temperature is 42.6F then the following calculation will be made:

$42.6 - 44.0 = 1.4 \times 2 / 1 = 2.8$. Since this is less than 10.0 the valve opening will be reduced an additional 2.8%.

When the valve reaches its maximum opening of 100.0% (Setpoint #122) the economizer function will use other fans if they are available. In this example there are no fans that are associated only with economizer but the condenser fans can now be used. After the time delay of 120 seconds (Setpoint #125) the first condenser fan will be turned on (the first fan of the first compressor unless unavailable).

At this point the unit state is ECONOMIZER ONLY, the economizer valve is at 100%, and the compressor fans will be used to aid in the economizer cooling. The delay between starting the condenser fans will be 30 seconds (Setpoint #124). If all condenser fans are available and not manually turned off, the pattern of starting fans will be the first fan on compressor 1, after the delay then the first fan of compressor 2, after the delay then the second fan on compressor 1. This will continue until all available condenser fans have been turned on.

Once all of the condenser fans have been turned on there will be a delay of 240 seconds (Setpoint #107). At this time the Unit State will be changed and mechanical cooling will be enabled. When a compressor is running, its associated condenser fans will be controlled by the discharge pressure of the running compressors.

16.32. High Suction Superheat Safety

To add a high suction superheat safety, make Setpoint #203 "HiSuctSheat" active. If the suction superheat is greater than the value of this Setpoint for the 'Time(sec)' field, an alarm will be generated and the compressor will be shut down with a safety or Lockout state.

16.33. Low Temperature Safety and Unload (Low Saturated Suction Temperature)

The Magnum is set up to check for low refrigerant temperature safety and unload functions. To enable this test make Setpoint #155 "LO REF TMP" active and point to the sensor in the 'Refrigeration Temp' column of the Compressor SI grid in MCS-Config.

This safety will be checked only when the compressor is running. If the sensor value is less than Setpoint #155 for the 'Time(sec)' field, then an alarm message will be generated and the associated compressor will either be placed in a safety or Lockout state.

The Magnum will also determine if a low temperature condition occurs and to stop loading or unload if necessary. If the sensor value is less than the value of Setpoint #155 plus Setpoint #156 "LO REF UNLD", then the compressor state will be LO TMP UNLOAD. Refer to state (21) in section 6.2.26.

By using the User Logic type sensor, we can test any value for a low condition. For example point the refrigerant temperature index to a User Logic sensor that picks up the saturated suction temperature for that compressor. Make Setpoint #155 active with the low temperature value that will trigger the safety and unload action and you have a low saturated suction temperature condition.

Chapter - 17. VFD Controlled Compressors

17.1. INTRODUCTION

The MCS Magnum controller is designed to control Variable Frequency Drive (VFD) centrifugal compressors. Its algorithm allows the user to define specific functions to maximize startup and running conditions. It handles all of the following:

1. Startup control
2. DX chiller barrel
3. DX remote coils
4. Flooded chiller barrel
5. Water cooled condenser
6. Air cooled condenser
7. Slide control for starting unloaded
8. EXV startup control
9. EXV Anticipatory loading
10. EXV low suction Anticipatory control

17.2. STARTUP CONTROL

When the compressor is started the state will be 'CMP IN STARTUP'. During this phase the compressor's Analog output will be placed at the percentage specified in the Config for startup and for the length of time specified. If the compressor has a slide valve it will be started unloaded. After a few seconds the slide is moved to the loaded position and all control is via the VFD. In the MCS Config the user can specify the following:

1. The starting frequency of the compressor which is via the compressor's Analog Output.
2. The length of time the compressor is to remain in 'CMP IN STARTUP' state.
3. The starting position of the Electric Expansion Valve (EXV).

17.3. OPERATING CONTROL

When the compressor completes the startup phase it enters normal operating controls. In the normal operating phase the primary function is to maintain the target based on the controlling sensor. (Usually this is Leaving Water Temperature.) To do this the following control functions occur:

1. The compressor Analog output will be adjusted to match the current wanted capacity percent.
2. The EXV position will be adjusted when the compressor speed is adjusted and depending on the current value of its superheat.
3. The compressor slide remains at 100% during normal operating control.

17.4. COMPRESSOR LOADING / UNLOADING

The standard MCS algorithm applies. However for the VFD controlled screw additional set point capabilities have been expanded as follows:

1. On a standard slide operated screw SP 32 'MAX ADJUST %' would usually be set to 4% to 5%. With the VFD it is typical to allow larger adjustments, when required, say to 10%. The loading/unloading algorithm can be set to increase/decrease slowly because the VFD allows exact positing of the capacity.
2. Controlling this adjustment is SP 56, 'COMP ADJ DELAY', which tells the Magnum the frequency to set. The EXV is adjusted at the same time allowing precise superheat control.

17.5. COMPRESSOR SHUTDOWN

Compressor shutdown is a function of the set point values setup at Config time. Normal function would be to shutoff the EXV and pump down based on set points. However if it's a flooded evaporator no pump down is done. When the compressor is off the MCS control system forces the slide vale to its minimum position so at the next start time the compressor is unloaded.

17.6. Staging

- **Vane Position Indicator is required – A high quality potentiometer**
 - Vanes are 0% open – fully closed
 - Comp Speed set to 100% - 60hz on VFD
 - As the load requires the Vanes are pulsed open
- **When Chilled Water Out Temp reaches Target setpoint**
 - First the comp speed is reduced as required to hold temp
 - If the comp speed reaches Minimum Allowed speed then the Vane are pulsed closed as required to hold temp
- **If Chilled Water Out Temp rises above the Target setpoint**
 - First the Vanes are pulsed open as required to achieve target
 - If the Vanes reach 100% open then the comp speed is increased as required to hold temp

17.7. VFD Interface - Hardwired

- MCS-Magnum relay output wired to run on VFD
- MCS-Magnum Analog output wired to speed control on the VFD, 0-10Vdc equals 0-60Hz.
- Min speed allowed is set in MCS-Magnum setpoint
- VFD Fault wired to MCS-Magnum Sensor Input
- Magnum can except 0-5vdc analog outputs from VFD for Hz, Amps, etc.

17.8. VFD Setting

- Speed control by external 0-10Vdc signal, where 0Vdc = 0Hz and 10Vdc = 60Hz.
- Min Freq=38Hz(2400 rpm) & Max Freq=60hz(3600rpm)
- Accel Time & Decel Time = 30 seconds
- Emergency Decel Time = 1 second
- Break Point Freq = 35Hz
- Stall Freq = 20Hz & Stall Time = 20 seconds
- Torq Boost Current = 100%

17.9. CONFIG CONSIDERATIONS

There are a number of considerations when setting up the set points. Some of the relations have multiple functions allowing for almost unlimited control. Listed below are some of the set points and recommended starting values: (All values are in degrees F and PSI)

SP #	SP NAME	VALUE	TIME	DISCRIPTION
9	SUPERHEAT TARGET	12F	7SEC	The time field is usually between 6 and 8 seconds. It defines the ROC time of the superheat. When LOW SUCTION OPENING it also defines when to stop opening. (When the ROC is zero, the slope has gone positive, it stops the EXV from continuing to open eliminating overshoot.)
13	EXV COURSE	0.5%	2	This set point is the EXV adjustment made when in 4X opening or closing. Change the set point type to 'TIME' and the value in time will become a multiplier for the adjust made when in "LO PSI OPENING". Recommend to start at 2. If the compressor goes into LOW SUCTION OPENING the value in this set point will be multiplied by the value in time and this value will be used to adjust the EXV.

65	EXV ZONE X1	2F		Using SP 65, 66, 67, 69, 70,71 & 72 allow individual control of each EXV zone. Changing SP 65 type to 'TARGET' allows the value in 'NIGHT SETBACK' to increase/decrease the position of Y2 in the EXV chart. If using a negative value you should be careful not to go below SP 17 'LOW SUPERHEAT'.
32	MAX ADJUST %	10%		This allows larger adjustments based on capacity wanted but at a controlled loading rate.
33	MIN ADJUST %	1%		This is the minimum value to adjust based on the controlling sensor. This set point value also defines the adjustment to the compressor speed Analog output when the AO is not equal to the wanted %.
56	CMP ADJ DELAY	2SEC		This specifies that the compressor speed is to be adjusted every 2 seconds until the actual compressor capacity % matches the wanted capacity %.

Chapter - 18. Centrifugal VFD Control Logic

18.1. Control Logic – Surge Avoidance

■ **Surge Line is used to avoid the Surge Area**

- Saturated temperatures are used to calculate Lift
- Min Allowable Speed is determined by the calculated Lift

18.2. Control Logic – Surge Protection

- If the ROC drops and then increase within 30 seconds – this is a Surge. (Setpt #210 for Amp = 8 & Setpt #211 for Lift = 4)
- Magnum calculation the Rate of Change every second for Amps & Lift
- If 2 surges (setpt #212) in 60 seconds (setpt #213) the Magnum increases Speed (setpt #205) & close the Vanes
- Every time another surge occurs – increase speed & close the Vanes
- If no surges occur for 2 minutes (setpt #204) return to normal staging logic
- If 8 surges (setpt #209) occur in 5 minutes (setpt #209 time) then trip the comp on “COMP SURGING”

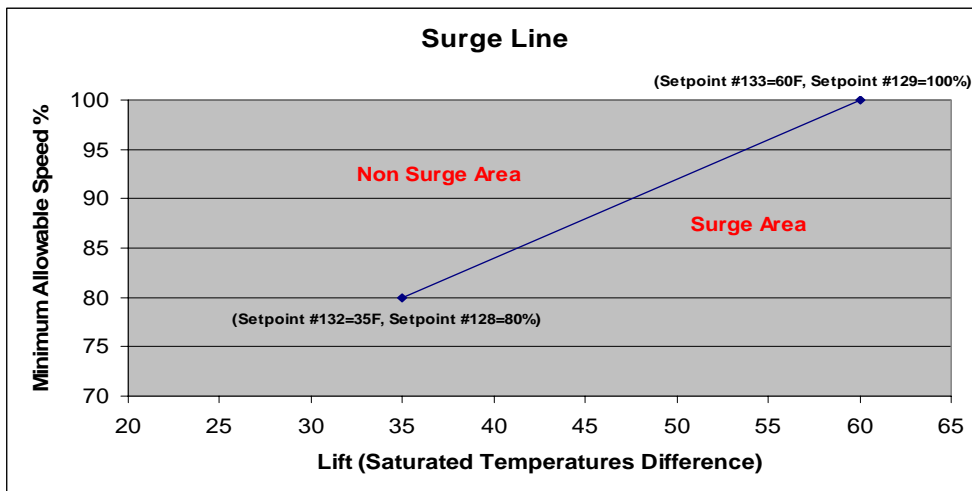

18.3. Surge and Stall Protection:

Surge is an unstable condition that occurs at low mass flows. Surges decrease compressor performance and efficiency, and could even cause permanent equipment damage.

CENT V17 defines a single surge as a large decrease in compressor amps followed by a large increase in the amps or a large decrease in lift pressure followed by large increase in lift pressure. The CENT V17 software will keep the last 60 seconds of samples for both amps and lift pressure. It will calculate the last ten 1 second Rate of Changes for both amps and lift pressure. If within these 10 Rate Of Changes there is a value less than (Setpoint #220 “AmpSurgeROC” x -1) or (Setpoint #221 “LiftSurgeROC” x -1) followed by a value greater than Setpoint #220 or #221, a compressor surge has occurred.

The software will then count the number of compressor surges that occur. If the number of surges is more than the value in Setpoint #219 “ExcessSurges” within 5 minutes (value of Setpoint #219 ‘Time (sec)’ field) the system will shut down and generate an “ExcessSurges” alarm. This safety condition will automatically restart the compressor after the time in the Safety Down Time of the Setpoint #219. If a second “ExcessSurges” occurs within the time of the Lockout Delay Field, the compressor will be placed in “Cmp Locked Out” state and a manual reset is required to enable the compressor to restart again.

18.4. Lift Based Surge Prevention Logic:

This logic looks at the current evaporator differential to determine if the current compressor lift (saturate lift temp) is above safe conditions for that differential. If the saturated lift temp rises above the calculated max safe lift temp for that differential, we will then force the compressor into a surge prevention unload. The Compressor will continue to unload until the saturated lift temp falls .6°F below the maximum safe lift temp.

The logic accomplishes this by looking at 2 separate lookup tables, the first lookup table takes the evaporator differential and converts it to a 0-100% line. The minimum and maximum evaporator differential temp values will need to be input into the first lookup table depending on the design of the unit.

Example:

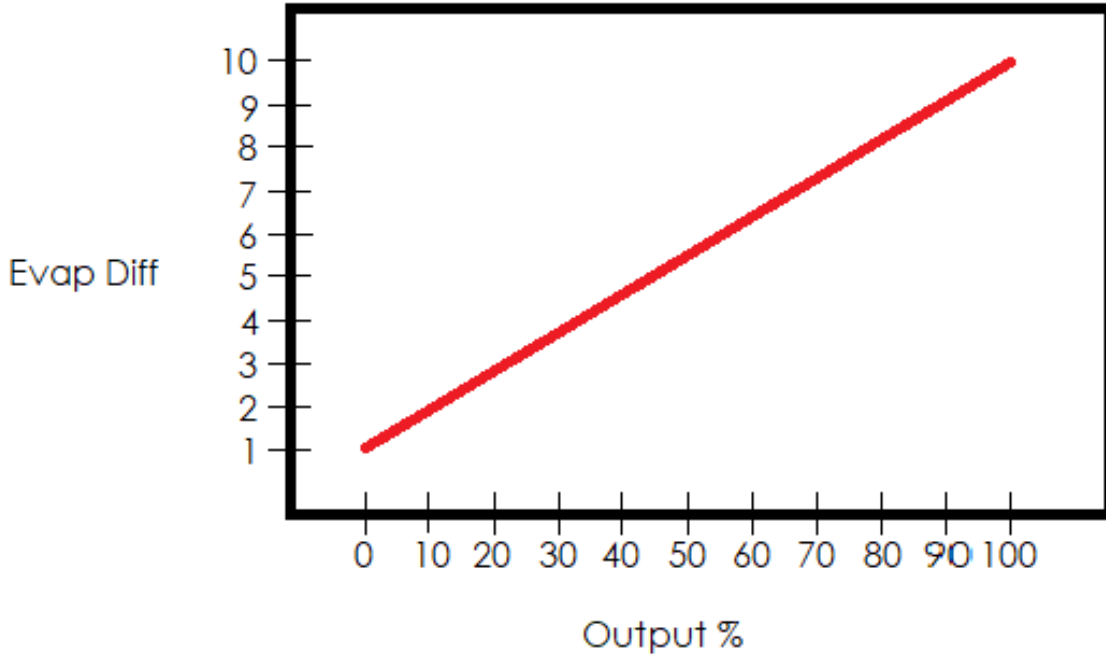

The second lookup table takes the 0-100% output from the first table and applies that to the maximum safe lift values for the unit. In the graph below, the unit has a maximum safe saturated lift temp of 38°F at 1°F evaporator differential, and a maximum safe saturated lift temp of 59°F at 10°F of evaporator differential.

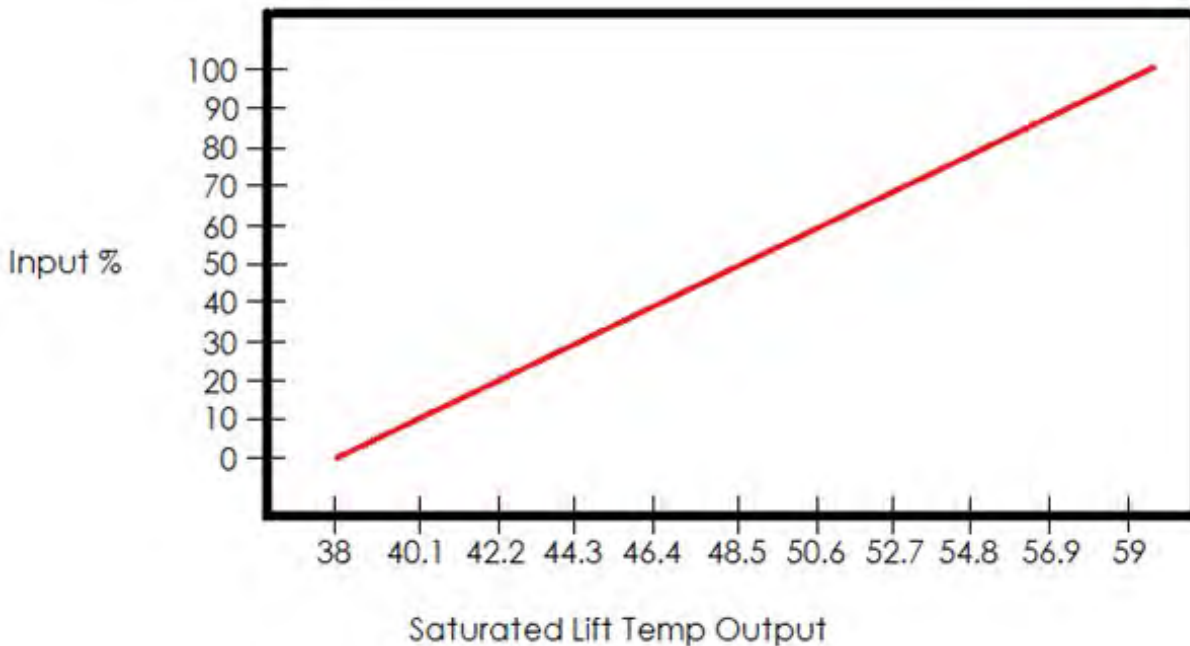

Chapter - 19. Condenser Control Logic

Many condenser types are supported by the Magnum controller including individual condensers per circuit, shared condensers between multiple circuits, and common condensers for all circuits. The type of condenser plus the number of Relay Outputs needed are specified in MCS-Config.

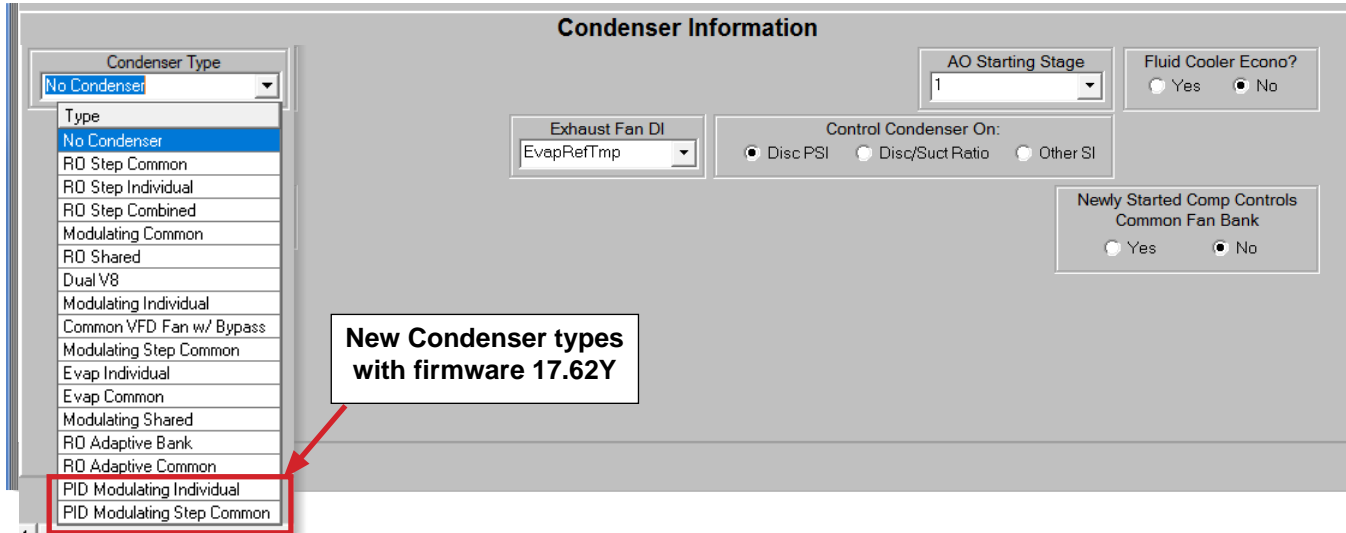

The Magnum supports the following Condenser Types:

- **No Condenser**
No condenser specified.
- **RO Step Common**
The highest discharge pressure from any compressor on the system will be the controlling pressure.
- **RO Step Individual**
Each compressor will have one or more condenser Relay Outputs associated with it. The discharge pressure on that compressor will be the control pressure for its own condenser.
- **RO Step Combined**
The highest discharge pressure from either of the compressors on the shared circuits will be the controlling pressure (circuits 1 and 2 are shared, circuits 3 and 4 are shared, circuits 5 and 6 are shared, and circuits 7 and 8 are shared).
- **Modulating Common**
The highest discharge pressure from any compressor on the system will be the controlling pressure. The Analog Output is modulated based on the Rate of Change of the controlling discharge pressure. It can also be controlled on a selected sensor input.
- **Modulating Step Common**
This type of condenser has a common fan bank for the system. The control will be on the systems highest discharge pressure. The Relay Outputs are also supported along with an Analog Output.
- **Modulating Individual**
Each compressor will have its own condenser Analog Outputs associated with it. The Analog Output for each circuit is modulated based on its own discharge pressure Rate of Change. It can also be controlled on a selected sensor input. You may also select Relay Outputs to be turned ON/OFF while modulating the Analog Output.

■ RO Shared

This type of condenser will take the highest discharge pressure of circuits 1 and 2, then 2 and 3, then 3 and 4, etc. to use as the control discharge pressure. This condenser type does not have the option to bypass the startup compressor.

■ Dual V8

This special type of condenser is a common control air condenser with two stages of fans plus a VFD Fan. Control of the fan speed will be different depending on whether one or two stages are on. All compressors are in the same fan bank with the highest discharge pressure being the control.

■ Common VFD Fan with Bypass

Three consecutive Relay Outputs, an Analog Output, and a VFD fault indicator are required to control this type of condenser. RO's needed:

- 1) VFD LOAD—This relay will be ON indicating the fan can be used.
- 2) VFD BYPS—This relay will be OFF unless a VFD fault has occurred.
- 3) VFD ENAB—This relay will be ON unless a VFD fault has occurred.

During normal operation, VFD LOAD will be on, VFD BYPS will be off, and VFD ENAB will be on. The fan will be modulated as required by the condenser or economizer logic. If a fault occurs, all relays will be turned off and the VFD will be set to 0. The Magnum will wait for the time specified in Setpoint #90 "COND FAULT" before the fan will be run without VFD control if it is needed by the condenser logic (economizer logic will not function in this condition). Once this time has passed and the condenser logic calls for the fan, then VFD BYPS will be turned on thereby turning the fan on, however it will NOT be modulated.

The Magnum can also support a variable speed fan for all three of the air type of condensers. Each compressor can support a variable speed fan. The variable speed must be on the first Relay Output associated with that compressor.

Note 1: The discharge temperature must be at least 117° F and the discharge superheat needs to be at least 20° F to guarantee good oil separation.

Note 2: Condenser staging is critical if the Magnum is to function in different climates. The best option for air-cooled chillers is to have each fan on its own contactor and a frequency drive on fan 1. This configuration allows the most optimum control in all weather.

■ Modulating Step Common

Similar to the Modulating Common type with the addition of relay outputs. The highest discharge pressure from any compressor on the system will be the controlling pressure. The Analog Output is modulated based on the Rate of Change of the controlling discharge pressure. It can also be controlled on a selected sensor input. When the analog output reaches its maximum value and more cooling is required the next relay will be turned on and the analog output value will be set to its minimum value.

■ Evap Individual

Evaporative condensers are used to improve the condensers efficiency by spraying water over the condensing coil from above while air is blown up through the coil from below. Each compressor will have its own condenser Analog Outputs associated with it. The Analog Output for each circuit is modulated based on its own discharge pressure Rate of Change. It can also be controlled on a selected sensor input. You may also select Relay Outputs to be turned ON/OFF while modulating the Analog Output.

■ Evap Common

Evaporative condensers are used to improve the condensers efficiency by spraying water over the condensing coil from above while air is blown up through the coil from below. Similar to the Modulating Common type with the addition of relay outputs. The highest discharge pressure from any compressor on the system will be the controlling pressure. The Analog Output is modulated based on the Rate of Change of the controlling discharge pressure. It can also be controlled on a selected sensor input. When the analog output reaches its maximum value and more cooling is required the next relay will be turned on and the analog output value will be set to its minimum value.

- **RO Adaptive Bank– Air cooled Condenser Fan Control**
 Used to control the condenser fan relay outputs for a single compressor, multiple compressors on the same refrigerant circuit, or a bank of condenser fans for multiple refrigerant circuits. If single compressor the condenser fans are stage on/off based on the compressor discharge pressure. If multiple compressor or refrigerant circuit, then the high discharge of the running compressors is used to stage condenser fans.
- **RO Adaptive Common – Air Cooled Condenser Fan Control**
 Used to control the condenser fan relay outputs for all the refrigerant circuits on the unit. This control logic finds the high discharge pressure on the running compressors and uses it to stage on/off the condenser fan relays.
- **PID MOD Individual**
 Required software:
 Config version 18.01V or later
 Connect version 18.31 or later
 Firmware 17.62Y (all firmware except LWC MAG and CPM MAG)
 Each compressor will have its own condenser Analog Outputs associated with it.
 PID control will turn an analog output into a stand alone PID controlled output. This output will have a controlling sensor that modulates the AO to a maintain target. This logic will run all the time.
- **PID Step Common**
 Required software:
 Config version 18.01V or later
 Connect version 18.31 or later
 Firmware 17.62Y (all firmware except LWC MAG and CPM MAG)
 This type of condenser has a common fan bank for the system. The control will be on the systems highest discharge pressure.
 PID control will turn an analog output into a stand alone PID controlled output. This output will have a controlling sensor that modulates the AO to a maintain target. This logic will run all the time.

19.1. Condenser Introduction

19.1.1 RO Step Condenser Cut In – Out Logic

The Cut In and Cut Out Logic Setpoints are as follows:

- Setpoint #45 “CND STG1 ON” - Condenser stage 1 Cut In (ON).
- Setpoint #46 “CND STG1 OFF” - Condenser stage 1 Cut Out (OFF).
- Setpoint #47 “CND DIFF ON” - Cut In differential for additional condenser stages for (ON).
- Setpoint #48 “CND DIFF OFF” - Cut Out differential for additional condenser stages (OFF).
- Setpoint #49 “CND MIN RUN” - Minimum run time for a condenser stage

Condenser Relay Outputs will be turned on based upon the value in Setpoint #45 “CND STG1 ON”. When discharge pressure reaches this value, the first condenser Relay Output is turned on. If additional condenser outputs are present, they will be turned on when the pressure exceeds the cut in value plus the value contained in Setpoint #47 “CND DIFF ON”. When discharge pressure falls, the condenser outputs will be turned off based upon the Setpoint #46 “CND STG1 OFF” plus the value contained in Setpoint #48 “CND DIFF OFF”. The first step will be turned off when discharge pressure falls below Setpoint #46 “CND STG1 OFF”.

Example: COND FAN 1 ON at 200 psi (Discharge)

Setpoint #45 “CND STG1 ON” = 200 psi	COND FAN 1 OFF at 170 psi
Setpoint #46 “CND STG1 OFF” = 170 psi	
Setpoint #47 “CND DIFF ON” = 20 psi	COND FAN 2 ON at 220 psi (200 + 20)
Setpoint #48 “CND DIFF OFF” = 5 psi	COND FAN 2 OFF at 175 psi (175 + 5)
COND FAN 3 ON at 240 psi (220 + 20)	
COND FAN 3 OFF at 180 psi (175 + 5)	

19.1.2 RO Step Condenser with Variable Speed Fan

The Setpoints for variable speed fan control are as follows:

Setpoint #54 “CND MIN SPD” - Minimum variable speed allowed.

Setpoint #55 “CND MAX SPD” - Maximum variable speed allowed.

The purpose of the variable speed fan is to reduce the cycling of the fans by adjusting the speed of the variable fan point. This control works in conjunction with the Cut In and Cut Out logic of each compressor. When a fan is turned on, the speed of the variable point for that compressor is set to maximum allowed percentage. As the discharge pressure falls, the fan speed is adjusted proportionally. When the minimum is reached the fan will turn off.

19.1.3 Condenser Control

The Condenser Control logic is run with every pass of the algorithm.

19.1.3.1. Common Terms

Information that relates to condensers on the circuit

# Cond Faults	Cond Fan Bank	Condenser Coil Temp #1	Condenser Coil Temp #2	Tandem EXV Circuit #	EXV Control	Suction Group	Comp Name/ID
0	1	Not Used	Not Used	1	Suct Spht	1	1
0	2	Not Used	Not Used	2	Suct Spht	2	2
0	3	Not Used	Not Used	3	Suct Spht	3	3

Condenser Fan Bank:

Indicates which circuits share common condenser fans or are individually controlled.

Suction Group:

Indicates which circuits share a common suction line.

Fluid Cooler Econo?option:

Specifies if the Fluid Cooler Economizer (if used) can use the condenser fans or VFD.



19.1.3.2. Control Discharge Pressure Calculation

If control is based on discharge pressure, all types of condensers will operate in the following sequence. For compressors within the same fan bank or suction group, the compressor with the highest discharge pressure will be held as the control pressure, regardless if the compressors are running or not.

The newly started compressor will have the controlling discharge pressure even if it is not the highest value in order for it to build pressure (startup mode is defined as the compressor has been on for less than 5 minutes and its discharge pressure is less than the value of Setpoint #45 “CND STG1 ON” minus the value of Setpoint #47 “CND DIFF ON”). However, this logic will be overruled if another compressor sharing the same condenser approaches the high discharge safety (if discharge pressure rises above calculated value of Setpoint #81 “HI DISC PSI” minus #83 “HI DISC RELOAD”)

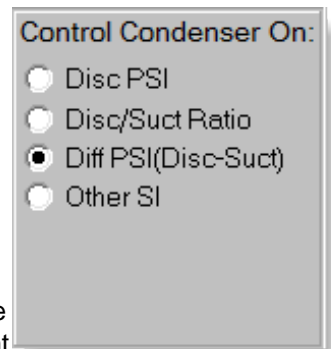

If control is based on Other SI, the value of that sensor is always used as the control discharge pressure.

Control Condenser On:

- **Disc PSI**–The Magnum will check for the compressor with the highest discharge and use that as the controlling pressure.

- **Disc/Suct Ratio** - Control logic will be the same as Disc PSI control except the ratio of the discharge pressure to the suction pressure will be used as the control. Note changes to related set points will be required.

- **Diff PSI(Disc-Suct) -**



HVAC FIRMWARE VERSION 17.34 and up
MCS-CONFIG VERSION 18.01G and up
MCS-CONNECT VERSION 18.20.06 and up
NEW LOGIC ADDED WITH THESE UPDATES

Control Condenser On:

- Disc PSI
- Disc/Suct Ratio
- Diff PSI(Disc-Suct)
- Other SI

Differential Condenser Target Adjustment

If Discharge Superheat <= for Seconds Then
 Increase Differential PSI Target By

If Discharge Superheat >= for Seconds Then
 Decrease Differential PSI Target By

Max Adjustment Allowed

This logic will utilize the calculated differential pressure (Discharge Pressure/Suction Pressure) to control the condenser.

Capacity Control State	Time	Wanted/ Actual	Step Delay	Wanted %	Rate of Change	Control On	
UNIT IS LOADED	00:30:20	2/2	10	100.0	0.0	CHILWTROUT= 55.0F	
State	Time	PSI Diff	FLA %	Steps	Lead?	Manual FLA %	Condenser Adjustment
1)CMP IS HOLDING	00:19:25	265.0P	100%	1	Yes	N/A	40.0P
2)CMP IS HOLDING	00:19:20	200.0P	100%	1		N/A	0.0P
Suction Temp	Saturated Suction	Suction Superheat	Disc Temp	Saturated Discharge	Disc Superheat	Subcooling	
1) 58.0	31.5	26.5	120.0	110.0	10.0	20.0	
2) 58.0	42.9	15.1	130.0	101.6	28.4	11.6	

Differential Condenser Target A...

If Discharge Superheat <= for Seconds Then
 Increase Differential PSI Target By

If Discharge Superheat >= for 30 Seconds Then
 Decrease Differential PSI Target By 20.0
Max Adjustment Allowed

CLEAR VALUE

1	2	3
4	5	6
7	8	9
-	0	.

ADJUST CANCEL

All condenser setpoints will remain the same for both modulating and step control.

When Diff PSI is selected the below information will become editable in the config program.

Here you will be able to customize adjustments to the differential target based on discharge superheat being low or high.

In this config example if discharge superheat falls below 20 degrees for 30 seconds then the differential target will be increased by 5 psi. If 30 more seconds goes by and the discharge superheat has not increased above 20 degrees then we will do another increase of 5 psi to the target. The adjustments will continue all the way

up to a maximum of 40 psi defined by our “Max Adjustment Allowed” box. Once discharge superheat is between the high and low settings the adjustment will hold where it’s currently at.

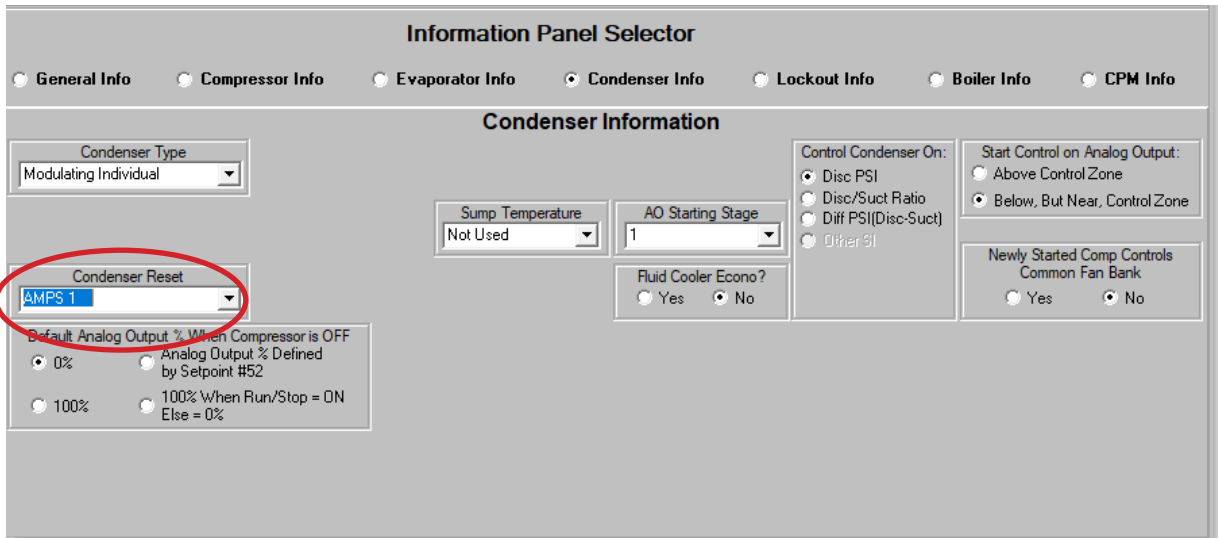

The logic works the same exact way when the discharge superheat rises above 40 degrees only we will decrease the differential every 30 seconds by 5 psi all the way back down to a 0 psi adjustment. The adjustments cannot go to a negative value.

MCS-CONNECT SCREEN ADJUSTMENT - Diff PSI(Disc-Suct)

- **Other SI** - Control logic will be the same as Disc PSI control except the value of the sensor that is specified will be used as the control. Note changes to related set points will be required. When this option is selected a “Other Control Sensor” window will enable the sensor to be selected.



To use ‘Other SI’, the condenser type must be a ‘COMMON TYPE’

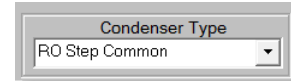

The Magnum will not check for the compressor with the highest discharge pressure but will always use the value of the sensor that is selected as the control.

19.1.3.3. Condenser Reset

If Diff PSI(Disc-Suct) is selected as your condenser type in the MCS Config program you’ll have a “Condenser Adjustment” box in your system status window through MCS Connect. Here you will see the adjustments made to your condenser target based on the discharge superheat. If you’re at least “Factory” authorized you can double click the value in the condenser adjustment box, it will open a window as you see in the example which will allow you to make changes to how the adjustments are made.

If sensor is specified its value will be added to the condenser control set points #45, #46 and #50.

19.1.3.4. Condenser Low Ambient

When a compressor is started its discharge pressure will be used as the controlling pressure for five minutes, enabling that compressor to build head pressure. However, if Setpoint #204 COND LOW AMB is active and there is an ambient temperature sensor reading less than this Setpoint, then this compressor’s discharge pressure will remain in control for an additional time as specified in the “Time (sec)” field.

19.1.3.5. Condenser Related Setpoints

The following are Condenser related Setpoints:

45	CND STG1 ON (RO Type)	When the discharge pressure is above this value, turn on the first stage of the condenser fans. 'Time (sec)' field: (Applies to compressors with shared condensers) If non-zero, then the compressor in startup state will not be in sole control of the condenser fans, it will control off of highest discharge pressure. If zero, then compressor in startup will have sole condenser control for 5 minutes. This option is selected in in the 'Newly started Comp Controls Common Fan Bank' box in the 'Condenser Information' panel under the MAGNUM screen.
46	CND STG1 OFF (RO Type)	If stage 1 of condenser capacity is on and the discharge pressure drops below this value, then turn this stage off.
50	CND TRGT (Modulating Type)	Target logic will try to maintain by modulating the AO. SP must be set up as target type. Hi/Low zones are used for setting control zone. If target type in HP mode, setback is added to target.

19.2. CONDENSER TYPES

19.2.1 No Condenser

This option indicates there is no condenser associated with this unit.

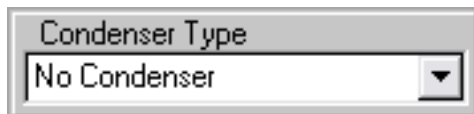

19.2.2 RO Step Common

The RO Step Common of condenser has one bank of fans. Make sure that all compressors in the Circuit Base point to the same common fan bank. The above example does not have a Fan Analog Output and there are three stages of fans starting with CND FAN 1 relay. All stages must be consecutive Relay Outputs.

Condenser Information

Condenser Type RO Step Common	Starting Cond RelayOutput CND FAN 1	# of Cond Stages 3	Fan AO Not Used	Fluid Cooler Econo? <input type="radio"/> Yes <input checked="" type="radio"/> No
Cond Starting Fault Not Used	# of Cond Fault 0	Sump Temp SI Not Used	Control Condenser On: <input checked="" type="radio"/> Disc PSI <input type="radio"/> Other SI	

Newly started Comp Controls
Common Fan Bank
 Yes No

For example:

Setpoint #	Name	Value
45	CND STG1 ON	200.0P
46	CND STG2 OFF	170.0P
47	CND DIFF ON	15.0P
48	CND DIFF OFF	5.0P

Discharge control pressure is 200.0 P, CND FAN 1, first condenser stage will be turned on.

If control pressure is equal to or greater than 215.0 P then the second stage will be turned on. (200.0 + (15.0 * 1))

If control pressure is equal to or greater than 230.0 P then the third stage will be turned on. (200.0 + (15.0 * 2))

Discharge control pressure is above 230.0 P; all three condenser stages are on.

When the control pressure drops below 180.0P the third condenser stage will be turned off. $(170.0 + (5.0 * 2))$

When the control pressure drops below 175.0P the second condenser stage will be turned off. $(170.0 + (5.0 * 1))$

When the control pressure drops below 170.0P the first condenser stage will be turned off. (170.0)

Condenser Faults

This example has no condenser faults. If used, and any one of the digital inputs are ON for the time specified in Setpoint #90 if active, then the unit will be locked out and an alarm message will be generated.

19.2.2.1. RO Step Common with a Fan AO and Condenser Faults

Condenser Information						
Condenser Type RO Step Common	Starting Cond RO CND FAN1-1	# of Cond Stages 3	Fan AO COMP1 SPD%	AO Starting Stage 1	Fluid Cooler Econo? <input type="radio"/> Yes <input checked="" type="radio"/> No	
Cond Starting Fault Cmp1VfdFit	# of Cond Fault 0	Sump Temperature Not Used	Control Condenser On: <input checked="" type="radio"/> Disc PSI <input type="radio"/> Disc/Suct Ratio <input type="radio"/> Other SI			
Condenser Reset OIL PSI 1						Newly Started Comp Controls Common Fan Bank <input checked="" type="radio"/> Yes <input type="radio"/> No

The above example is the same as the previous example with the addition of a Fan AO and two condenser faults.

Fan AO Control (same for all types of air condenser control)

Two more Setpoints than the previous example are needed to control the speed of the fan:

Setpoint #	Name	Value
54	CND MIN SPD	20.0%
55	CND MAX SPD	100.0%

CND FAN 1 will be turned on when the control pressure is equal to or greater than 200.0, same as in previous example. At this point the Fan AO speed will be set to its maximum value, Setpoint #55. If the pressure changes between 170.0 and 214.9 the fan speed will also be modulated proportionally between its maximum and minimum settings. If the pressure is at 185.0 the fan speed will be set to 61.2%. If the pressure is at 190.0 the fan speed will increase to 75.0%. This will provide precision control in maintaining optimum discharge pressure.

If the pressure increases to 215.0 the condenser's second stage will be turned on and the fan speed will also be at 100.0%. If the pressure changes between 175.0 and 229.9 the fan speed will also be modulated proportionally between its maximum and minimum settings.

If the pressure increases to 230.0 the condenser's third stage will be turned on and the fan speed will also be at 100.0%. If the pressure changes between 180.0 and 229.9 the fan speed will also be modulated proportionally between its maximum and minimum settings. If the pressure is at 230.0 and above the fan speed will be at 100.0%.

As the pressure decreases toward the Cut Out point the fan speed will decrease toward its minimum setting. Once a stage is turned off, the fan speed will be set to 100.0% and again it will be modulated based upon the pressure.

Condenser Faults

This example has two condenser faults. They must be consecutive digital input types starting with FAN FLT 1. If either of these digital inputs are ON for the time specified in Setpoint #90 if active, then the unit will be locked out and an alarm message will be generated.

19.2.3 RO Step Individual

Condenser Information

Condenser Type
RO Step Individual

AO Starting Stage
1

Fluid Cooler Econo?
 Yes No

Condenser Reset
OIL PSI 1

Sump Temperature
Not Used

Control Condenser On:
 Disc PSI
 Disc/Suct Ratio
 Other SI

Newly Started Comp Controls
Common Fan Bank
 Yes
 No

The RO Step Individual has a bank of fans for each compressor. The number and location of the fan are specified under the Circuit Base screen.

Information that relates to condensers on the circuit														
	Circuit # (reset button)	# of Cond ROs	Starting Condenser RO	Condenser Fan AO	Starting Condenser Fault	# Cond Faults	Cond Fan Bank	Condenser Coil Temp #1	Condenser Coil Temp #2	Tandem EXV Circuit #	EXV Control	Suction Group	Comp Name/ID	
▶	1	...	3	CND FAN 1	Not Used	Not Used	0	1	Not Used	Not Used	1	Suct Sph	1	1
	2	...	3	CND FAN 2	Not Used	Not Used	0	2	Not Used	Not Used	2	Suct Sph	2	2

of Cond ROs –Total number of Relay Outputs of each compressor, in this example there are 3. The number of fans in each compressor does not have to be the same.

Starting Condenser RO – The starting condenser Relay Output. All the Relay Outputs specified for each circuit must follow consecutively to this point. In this example CND FAN 1 is the starting Relay Output for circuit 1 and the other 2 fans follow consecutively in the RO screen.

Condenser Fan AO–If a condenser fan AO was specified in this cell it would function as described in the example in section 7.74.3.6 RO Step Common with a Fan AO and Condenser Faults. There is no condenser fan AO in this example.

Starting Condenser Fault–If there were condenser faults specified in this cell they would function as described in the example in section 7.74.3.6 RO Step Common with a Fan AO and Condenser Faults. There are no condenser faults in this example.

Cond Faults – Total number of Condenser Faults.

Cond Fan Bank – In this type of condenser all compressors should have a different fan bank.

Condenser Information

Condenser Type
RO Step Combined

AO Starting Stage
1

Fluid Cooler Econo?
 Yes No

Condenser Reset
OIL PSI 1

Sump Temperature
Not Used

Control Condenser On:
 Disc PSI
 Disc/Suct Ratio
 Other SI

Newly Started Comp Controls
Common Fan Bank
 Yes
 No

Each compressor fan bank is controlled individually. The discharge pressure for each compressor is used to control condenser logic.

19.2.4 RO Step Combined

The RO Step Combined has a bank of fans that are shared by two consecutive circuits. The number and location of the fans are specified in the Circuit Base screen. This is similar to the RO Step Individual set up except only every other compressor has a condenser fans associated with it.

Information that relates to condensers on the circuit												
Circuit # (reset button)	# of Cond ROs	Starting Condenser RO	Condenser Fan AO	Starting Condenser Fault	# Cond Faults	Cond Fan Bank	Condenser Coil Temp #1	Condenser Coil Temp #2	Tandem EXV Circuit #	EXV Control	Suction Group	Comp Name/ID
1	...	3	FAN 1&3 #1	Not Used	Not Used	0	1	Not Used	Not Used	1	Suct Spl	1
2	...	0	Not Used	Not Used	Not Used	0	1	Not Used	Not Used	2	Suct Spl	2
3	...	3	FAN 2&4 #1	Not Used	Not Used	0	3	Not Used	Not Used	3	Suct Spl	3
4	...	0	Not Used	Not Used	Not Used	0	3	Not Used	Not Used	4	Suct Spl	4

Circuit 1 and 2 will share the same fan bank specified in the 'Cond Fan Bank' cell. Circuit 3 and 4 will also share the same fan bank specified. The highest discharge pressure between the two compressors on each respective circuit will be used as the control pressure for their fan bank.

Condenser Faults

If any of these digital inputs are ON for the time specified in Setpoint #90 if active, then both compressors sharing that condenser will be locked out and an alarm message will be generated. This example has no condenser faults.

19.2.5 Modulating

19.2.5.1. Modulating Common

Condenser Information

Condenser Type
Modulating Common

AO Modulating Valve
CND1 VFD%

Fluid Cooler Econo?
 Yes No

Sump Temperature
Not Used

Control Condenser On:
 Disc PSI
 Disc/Suct Ratio
 Other SI

Condenser Reset
Cmp2VfdFlt

Start Control on Analog Output:
 Above Control Zone
 Below, But Near, Control Zone

Newly Started Comp Controls
Common Fan Bank
 Yes No

Default Analog Output % When Compressor is OFF

This type of condenser uses water for condenser cooling. The AO Modulating Valve will modulate the cold water valve based upon the system's highest discharge pressure.

48	CND ADJ DELAY (Modulating Type)	If active this is the time in seconds between condenser adjustments to the AO. If inactive, then 30 seconds will be used as the delay. If type is DELAY: (required for condenser relay delays). -MIN VFD Opening cell contains the time delay between turning on a relay and moving the AO to its minimum position (Setpoint #52). -MAX VFD Opening cell contains the time delay between turning off a relay and moving the AO to 100%.
49	CND START % (Modulating Type)	If active, then the value is the starting % for the AO when the RO that is tied to it turns on. The value in the "Time (SEC)" cell is the AO starting stage. If no Relays are used when CMP starts set value.
50	CND TARG (Modulating Type)	Target logic will try to maintain by modulating the AO. SP must be set up as target type. Hi/Low zones are used for setting control zone. If target type in HP mode, setback is added to target.
51	CND ADJ DIV (Modulating Type)	Controls scaling of the amount the AO is adjusted (usually 1). The larger the number the smaller the AO adjustment as the adjustment will be divided by this value.

52	CND MIN % (Modulating Type)	Minimum AO % allowed. If compressor is off, then check the "Time (SEC)" field: If 0, then the AO % will be set to the value of this Setpoint. If 2 and the run/stop is set to run, then set the AO % to 100%, else set the AO % to 0%. This option is selected in the "Default Valve Opening % when Comp. is OFF" box in the condenser information section in the MAG HVAC screen.
53	CND ROC- (Modulating Type)	Maximum negative rate of change allowed. If the rate of change is less than this Setpoint, then stop modulating the AO. The absolute value of this Setpoint also serves as the maximum positive rate of change allowed. If the rate of change is greater than the absolute value of this Setpoint, then stop modulating the AO.
54	CND ADJ MULT (Modulating Type)	Controls scaling of the amount the AO is adjusted. The larger the number the larger the AO adjustment as the adjustment will be multiplied by this value.
55	CND MIN ADJ (Modulating Type)	The value in this Setpoint is the minimum % the AO will be modulated when a change is made.

Note 1: The purpose of Setpoint #193 'CND HI/LO ZONE' and the delays in the MAX AND MIN VFD Opening cells for Setpoint #48 'CND ADJ DELAY' are to prevent repeated cycling of additional stages.

Note 2: The purpose of Setpoint #194 'CND 2nd ZONE' is to prevent the discharge pressure from over shooting the target (Setpoint #50 'CND TARG'). The way the logic works is if the discharge pressure is in the 2nd Zone and the pressure is falling less than twice the CND ROC- (Setpoint #53 'CND ROC-') then a negative adjustment will be made to the AO. If the discharge pressure is raising more than twice the rate of change (Setpoint #53) then a positive adjustment will be made to the AO.

Note 3: The value in the "AO Starting Stage" cell under the MAG HVAC screen in the condenser info section is the stage that has to be turned on to begin modulating the AO.

The following applies to both the modulating common and individual water condenser types:

The 'Default Valve Opening % when Comp. is OFF' cell can be used to set the valve (1) to be completely closed (0%), (2) the value of Setpoint #52 (Valve % defined by Setpoint #52), or (3) completely open (100% if the Run/Stop indicator = ON else = 0%).

The delay timer will be decremented by a standard value of 1 every second, however if the control discharge pressure is more than 15.0 psi (1.5 bar) away from the target Setpoint #50, then the delay will be decremented by 2; if more than 20.0 psi (2.0 bar) away from the target then the delay will be decremented by 4.

When the delay counts down to zero, an adjustment will be made based on the equation:

(Control discharge pressure – Setpoint #50) × Setpoint #54 ÷ Setpoint #51 = Adjustment Value.

When the control discharge pressure is greater than Setpoint #50 plus the value in the high zone:

If the control discharge pressure rate of change is dropping too fast (more than twice the value of Setpoint #53), then close the valve by the calculated adjustment. If the control discharge pressure rate of change is dropping too slowly (more than the value of Setpoint #53), then open the valve by the calculated adjustment. Else make no adjustment.

When the control discharge pressure is less than Setpoint #50 minus the value in the low zone:

If the control discharge pressure rate of change is increasing too fast (more than twice the value of Setpoint #53), then close the valve by the calculated adjustment. If the control discharge pressure rate of change is increasing too slowly (more than the value of Setpoint #53), then open the valve by the calculated adjustment. Else make no adjustment.

When the control discharge pressure is within the zone: If the control discharge pressure rate of change is increasing more than the value of Setpoint #53, then close the valve by 1 percent. If the control discharge pressure change is decreasing more than the value of Setpoint #53, then open the valve by 1 percent.

Modulating Condenser Type: If heat pump and the mode is HEAT (not in defrost) all condenser relays will be turned on and the VFD set to 100% when compressor is turned on. If the control pressure is above the control zone, the condenser will unload; if below the control zone the condenser will load else there will be no change.

19.2.6 Modulating Step Common

Condenser Information					
Condenser Type Modulating Step Common	Starting Cond RO CND FAN1-1	# of Cond Stages 2	Fan AO CND1 VFD%	AO Starting Stage 0	Fluid Cooler Econo? <input type="radio"/> Yes <input checked="" type="radio"/> No
Cond Starting Fault Not Used	# of Cond Fault 1	Sump Temperature Not Used	Control Condenser On: <input checked="" type="radio"/> Disc PSI <input type="radio"/> Disc/Suct Ratio <input type="radio"/> Other SI		
Condenser Reset Cmp2VfdFit	Start Control on Analog Output: <input type="radio"/> Above Control Zone <input checked="" type="radio"/> Below, But Near, Control Zone		Newly Started Comp Controls Common Fan Bank <input checked="" type="radio"/> Yes <input type="radio"/> No		
Default Analog Output % When Compressor is OFF <input checked="" type="radio"/> 0% <input type="radio"/> Analog Output % Defined by Setpoint #52 <input type="radio"/> 100% <input type="radio"/> 100% When Run/Stop = ON Else = 0%					

When a RO is being used with an AO the AO will key off the RO turning on. The RO will turn on when the discharge pressure enters the bottom of the CND HI/LO ZONE (Setpoint #193). At that time the AO will move to its starting % (Setpoint #49). The AO will stay at its starting % until the discharge pressure gets outside the top of the CND HI/LO ZONE (Setpoint #193). At that point the AO will modulate based on Setpoints #51, #53-55. Now if there are 2 RO's tied to the AO and the "AO Starting Stage" is 1 then once the AO gets to 100% the 2nd RO will be turned on after a delay (value in the "MIN VFD Opening" cell for Setpoint #48) and the AO will be set back to its minimum % (Setpoint #52) and then modulate as described above. Now if the pressure begins to fall and goes below the CND HI/LO ZONE (Setpoint #193) the AO will modulate. Once the AO gets to its minimum % (Setpoint #52) the 2nd RO will be turned off after a delay (value in the "MAX VFD Opening" cell for Setpoint #48) and the AO will be set back to 100% and continue to modulate as needed.

If the "AO Starting Stage" is 2 then when the discharge pressure enters the bottom of the CND HI/LO ZONE (Setpoint #193) the 1st RO (stage 1) will be turned on. The 2nd RO will turn on once the discharge pressure gets outside the Heating Info CND HI/LO ZONE (Setpoint #193) and the delay has been met (value in the "MIN VFD Opening cell" for Setpoint #48) at that time AO will be set to its starting % (Setpoint #49). If the discharge falls below the CND HI/LO ZONE (Setpoint #193) the AO will begin to modulate. Once the AO reaches its minimum % (Setpoint #52) it will turn off the associated RO after a delay (value in the "MAX VFD Opening" cell for Setpoint #48). The 1st RO will remain on until the discharge pressure falls below the CND HI/LO ZONE (Setpoint #193) and the delay has been met (value in the "MAX VFD Opening" cell for Setpoint #48).

19.2.6.1. Modulating Individual

Condenser Information	
Condenser Type Modulating Individual	Fluid Cooler Econo? <input type="radio"/> Yes <input checked="" type="radio"/> No
Sump Temp SI Not Used	Control Condenser On: <input checked="" type="radio"/> Disc PSI <input type="radio"/> Other SI
Default Valve Opening % when Comp. is OFF <input type="radio"/> 0% <input checked="" type="radio"/> Valve % defined by Setpoint #52 <input type="radio"/> 100% when Run/Stop = ON else = 0%	
Newly started Comp Controls Common Fan Bank <input checked="" type="radio"/> Yes <input type="radio"/> No	

This type of condenser uses water to provide cooling to the compressors. The AO Modulating Valve will modulate the cold water based upon this discharge pressure for each circuit. You may also select Relay Outputs to be turned ON/OFF while modulating the Analog Output.

The individual condensers must be set up in the Circuit Base screen.

The control will be similar to the Modulating Common type, except that the discharge pressure for each circuit will control its own condenser.

19.2.7 RO Shared

The RO Shared condenser has banks of fans that are shared between two consecutive circuits. The number and location of the fans are specified under the Circuit Base screen. This is similar to the RO Step Individual set up. Circuits 1 and 2 will share the fan bank that is specified in the circuit 1 grid in the Circuit Base screen. The highest discharge pressure of these two compressors will be used to control this bank of fans. Circuits 2 and 3 will share the fan bank that is specified in the circuit 2 grid in the Circuit Base screen. The highest discharge pressure of these two compressors will be used to control this bank of fans. In a unit with three circuits, circuit three will not have a fan bank associated with it. It shares circuit 2’s fan bank.

19.2.8 Dual V8

This is a special type of condenser. It is a common circuit control type with two stages of fans and VFD. The control of the fan speed will be different depending on whether one or two stages are on. All circuits are checked to calculate the control discharge pressure, and should be in the same fan bank.

If the control discharge pressure is less than Setpoint #45, then both condenser stages are off and the fan speed is zero.

If the control discharge pressure is greater than Setpoint #45 and less than Setpoint #46 stage 1 will be on. The fan speed will be equal the value of (Setpoint #55 minus Setpoint #54) divided by (Setpoint #46 minus Setpoint #45) and then multiplied by (control discharge pressure minus Setpoint #46) plus Setpoint #54.

If the control discharge pressure increases while in stage 1 above the value of Setpoint #46 plus Setpoint #48 for the time contain in Setpoint #49 stage 2 will be entered. Both relays will be on and the fan speed will be equal the value of (Setpoint #55 minus Setpoint #54) divided by Setpoint #46 and then multiplied by (control discharge pressure minus Setpoint #46) plus Setpoint #54.

If the speed of the condenser fan is less than Setpoint #54 it will be set to that value or if the speed of the condenser fan is greater than Setpoint #55 it will be set to that value.

19.2.9 Common VFD Fan w/Bypass

The Common VFD Fan with a Bypass type of condenser has one fan. All circuits will use this fan; make sure that all circuits in the Circuit Base point to the same common fan bank. The above setup shows that there is one condenser stage. However this type requires the following three consecutive Relay Outputs to be set up. For example:

1-5	...	VFD LOAD
1-6	...	VFD BYPASS
1-7	...	VFD ENABLE

This type of condenser requires one condenser fault. If the fault occurs then the VFD will be bypassed and the fan will run at 100% if needed.

45	CND STG1 ON (RO Type)	When the discharge pressure is above this value, turn on the first stage of the condenser fans. 'Time (sec)' field: (Applies to compressors with shared condensers) If non-zero, then the compressor in startup state will not be in sole control of the condenser fans, it will control off of highest discharge pressure. If zero, then compressor in startup will have sole condenser control for 5 minutes. This option is selected in the 'Newly started Comp Controls Common Fan Bank' box in the 'Condenser Information' panel under the MAGNUM screen.
	PID MOD Individual PID Step Common	Uses PID condenser control KP (Proportional). Setup as setpoint.
46	CND STG1 OFF (RO Type)	If stage 1 of condenser capacity is on and the discharge pressure drops below this value, then turn this stage off.
	PID MOD Individual PID Step Common	If active, uses Multiplier for Ki adjustments, (Integral Delay). Setup as setpoint
54	CND MIN SPD (RO Type)	Minimum speed percentage for variable speed condenser control.
	CND ADJ MULT (Modulating Type)	Controls scaling of the amount the AO is adjusted. The larger the number the larger the AO adjustment as the adjustment will be multiplied by this value.
55	CND MAX SPD (RO Type)	Maximum speed percentage for variable speed condenser control.
	CND MIN ADJ (Mod- ulating Type)	The value in this Setpoint is the minimum % the AO will be modulated when a change is made.

Fan control when there is no fault:

The highest discharge pressure of all the compressors is the control value.

The first relay, VFD LOAD, is on and the second relay, VFD BYPASS, is off.

When the control discharge pressure is greater than the value of Setpoint #45, then the third relay (VFD ENABLE) will be turned on and the VFD will be set to the value of Setpoint #55. If the control discharge pressure decreases the VFD will be modulated between Setpoints #54 and #55 based upon the control discharge pressure.

Assume Setpoint values:

45	CND STG1 ON	250 psi
46	CND STG1 OFF	170 psi
54	CND MIN SPD	20%
55	CND MAX SPD	100%
90	COND FAULT	30s

When the discharge control pressure is greater than 250 psi the relay VFD ENABLE will be on and the VFD on the fan will be set to 100%. If the discharge control pressure drops to 210, then the fan speed will be set to 60%. The discharge control pressure is half of its Cut In and Cut Out range ($250 - 170 = 80 / 2 = 40 = 170 + 40 = 210$) therefore, the VFD will be positioned to half of its range ($100 - 20 = 80 / 2 = 40 + 20 = 60$). The VFD will continue to be modulated in this manner until the discharge control pressure drops below 170. Then the VFD will be at 0% and relay VFD ENABLE will remain on. If the pressure goes above 170 the VFD will be modulated. For example if the discharge control pressure goes to 190.0 the VFD will be set to 50%.

Fan control when a fault occurs:

If a fault occurs, an alarm message will be generated, relay VFD LOAD will Lock off, relay VFD ENABLE will be off, the VFD speed will be set to 0% and the bypass, VFD BYPASS, will be enabled if needed after waiting for 30 seconds, Setpoint #90. Once the fan bypass is enabled and the discharge control pressure goes above 250 psi the bypass will be turned on enabling the fan to run at 100% and it will remain on regardless of the discharge control pressure.

If the fault resets itself, and is no longer on, the state of VFD LOAD will be set to AUTO, the VFD BYPASS relay will be turned off and VFD will be enabled to control the fan speed if it is needed.

54	CND MIN SPD	20%
55	CND MAX SPD	100%
90	COND FAULT	30s

When the discharge control pressure is greater than 250 psi the relay VFD ENABLE will be on and the VFD on the fan will be set to 100%. If the discharge control pressure drops to 210, then the fan speed will be set to 60%. The discharge control pressure is half of its Cut In and Cut Out range ($250 - 170 = 80 / 2 = 40 = 170 + 40 = 210$) therefore, the VFD will be positioned to half of its range ($100 - 20 = 80 / 2 = 40 + 20 = 60$). The VFD will continue to be modulated in this matter until the discharge control pressure drops below 170. Then the VFD will be at 0% and relay VFD ENABLE will remain on. If the pressure goes above 170 the VFD will be modulated. For example if the discharge control pressure goes to 190.0 the VFD will be set to 50%.

Fan control when a fault occurs:

If a fault occurs, an alarm message will be generated, relay VFD LOAD will Lock off, relay VFD ENABLE will be off, the VFD speed will be set to 0% and the bypass, VFD BYPASS, will be enabled if needed after waiting for 30 seconds, Setpoint #90. Once the fan bypass is enabled and the discharge control pressure goes above 250 psi the bypass will be turned on enabling the fan to run at 100% and it will remain on regardless of the discharge control pressure.

If the fault resets itself, and is no longer on, the state of VFD LOAD will be set to AUTO, the VFD BYPASS relay will be turned off and VFD will be enabled to control the fan speed if it is needed.

19.2.10 Evaporative types of Condenser Control

Evaporative condensers are used to improve the condensers efficiency by spraying water over the condensing coil from above while air is blown up through the coil from below.

Two types are support:

Condenser Information

Condenser Type Evap Individual	AO Starting Stage 0	Fluid Cooler Econo? <input type="radio"/> Yes <input checked="" type="radio"/> No
Condenser Reset Not Used	Sump Temperature Not Used	Control Condenser On: <input checked="" type="radio"/> Disc PSI <input type="radio"/> Disc/Suct Ratio <input type="radio"/> Other SI
Sump Level Indicator Not Used	Sump Heater Relay Not Used	Start Control on Analog Output: <input type="radio"/> Above Control Zone <input checked="" type="radio"/> Below, But Near, Control Zone
		Newly Started Comp Controls Common Fan Bank <input checked="" type="radio"/> Yes <input type="radio"/> No
Default Analog Output % When Compressor is OFF <input checked="" type="radio"/> 0% <input type="radio"/> Analog Output % Defined by Setpoint #52 <input type="radio"/> 100% <input type="radio"/> 100% When Run/Stop = ON Else = 0%		

- Evap Individual Step, has the same control logic as Modulating Individual.
- Evap Common, has the same control logic as Modulating Common.

In addition to the standard control logic, the evaporative spraying water requires addition input.

Sump Temperature, this sensor will provide the temperature of the sump, area where the spray water is held.

Sump Level Indicator, if set point #249 and a digital input is specified, if it is continually on for the time greater than the value of the safety time of set point #249 a Sump Low Level alarm will be generated and this condenser will locked off. If the digital goes to an off state and the condenser is locked off, its state will be changed to auto and the condenser will be available.

Sump Heater Relay, if this relay and sump temperature sensor is specified and set point #250 is active, this relay will be turned on and off based upon the values of set point #250.

19.2.11 RO Adaptive Bank- Air cooled Condenser Fan Control

Used to control the condenser fan relay outputs for a single compressor, multiple compressors on the same refrigerant circuit, or a bank of condenser fans for multiple refrigerant circuits. If single compressor the condenser fans are stage on/off based on the compressor discharge pressure. If multiple compressor or refrigerant circuit, then the high discharge of the running compressors is used to stage condenser fans.

Relay Output Information Screen												
Number	Name	Slide Mult.	Slide Div.	Slide Off.	Design Suc.PSI	Design Dis.PSI	Nominal Tonnage(of Step)	EXV Start (When Lead)	Type	EXV L Adjus	Circuit	
1-3	CND FAN 1	---	---	---	---	---	---	---	Standard	---	1	
1-4	CND FAN 2	---	---	---	---	---	---	---	Standard	---		

Singe Compressor

Information that relates to condensers on the circuit

Circuit # (reset button)	# of Cond ROs	Starting Condenser RO	Condenser Fan AO	Starting Condenser Fault	# Cond Faults	Cond Fan Bank	Condenser Coil Temp #1	Condenser Coil Temp #2	Tandem EXV Circuit #	Evaporator EXV Control	Suction Group	Comp Name/ID
1	2	CND FAN 1	Not Used	Not Used	0	1	Not Used	Not Used	1	Suct Spht	1	1

Tandem Compressors

Information that relates to condensers on the circuit

Circuit # (reset button)	# of Cond ROs	Starting Condenser RO	Condenser Fan AO	Starting Condenser Fault	# Cond Faults	Cond Fan Bank	Condenser Coil Temp #1	Condenser Coil Temp #2	Tandem EXV Circuit #	Evaporator EXV Control	Suction Group	Comp Name/ID
1	2	CND FAN 1	Not Used	Not Used	0	1	Not Used	Not Used	1	Suct Spht	1	1
2	0		Not Used	Not Used	0	1	Not Used	Not Used	2	Suct Spht	1	2

Tandem Compressors- 2 Circuits

Circuit 1 and 2 will share the same fan bank specified in the 'Cond Fan Bank' cell. Circuit 3 and 4 will also share the same fan bank specified. The highest discharge pressure between the two compressors on each respective circuit will be used as the control pressure for their fan bank.

Information that relates to condensers on the circuit													
Circuit # (reset button)	# of Cond ROs	Starting Condenser RO	Condenser Fan AO	Starting Condenser Fault	# Cond Faults	Cond Fan Bank	Condenser Coil Temp #1	Condenser Coil Temp #2	Tandem EXV Circuit #	EXV Control	Suction Group	Comp Name/ID	
1	3	FAN 1&3 #1	Not Used	Not Used	0	1	Not Used	Not Used	1	Suct Spht	1	1	
2	0	Not Used	Not Used	Not Used	0	1	Not Used	Not Used	2	Suct Spht	2	2	
3	3	FAN 2&4 #1	Not Used	Not Used	0	3	Not Used	Not Used	3	Suct Spht	3	3	
4	0	Not Used	Not Used	Not Used	0	3	Not Used	Not Used	4	Suct Spht	4	4	

19.2.12 RO Adaptive Common – Air Cooled Condenser Fan Control

Used to control the condenser fan relay outputs for all the refrigerant circuits on the unit. This control logic finds the high discharge pressure on the running compressors and uses it to stage on/off the condenser fan relays.

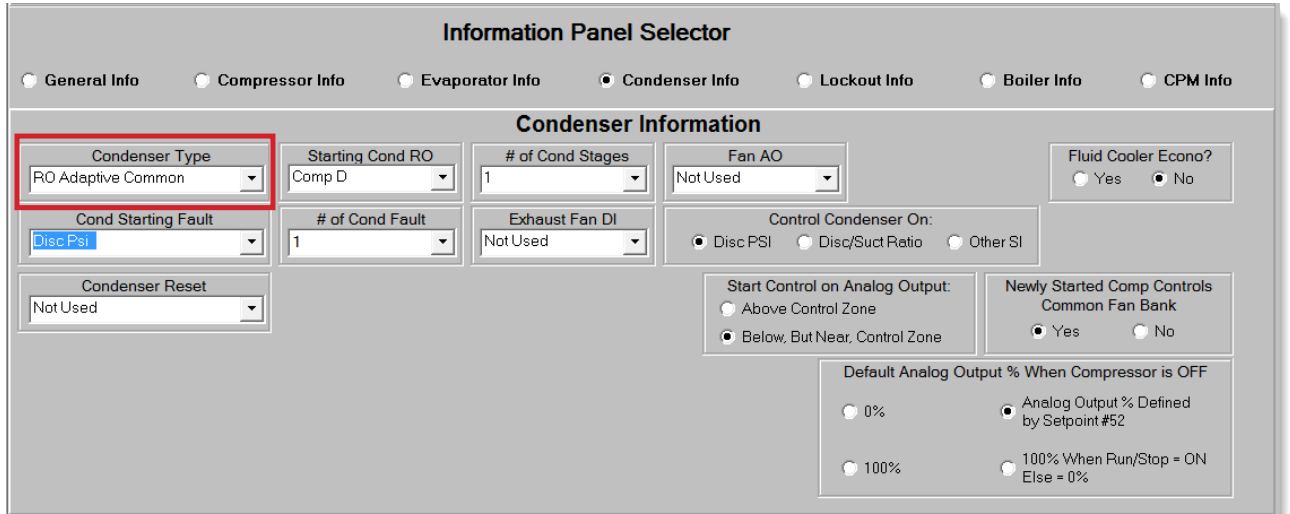

19.2.12.1. Adaptive Condenser Control Setpoints

Setpoint #45 “CND STG1 ON” – contains the value for turning on 1st condenser fan relay.

Setpoint #46 “CND STG2 OFF” – contains the value for turning off the 2nd condenser fan relay.

Setpoint #47 “CND DIFF ON” – contains the differential value for turning on the 2nd condenser fan., plus all the remaining condenser fan stages. This value is added to previous stage on value to calculate when to turn on the next condenser fan.

Setpoint #48 “CND DIFF OFF” – contains the differential value for turn off the 3rd condenser fan relay, plus all the remaining condenser fan stages. This value is added to the previous stage off value to calculate when to turn off the next condenser fan.

Setpoint #49 “CND STG1 OFF” – contains the value for turning off 1st condenser fan relay.

Setpoint #50 “CND TARG PSI” – contains the maximum adjusted value for turning on the last condenser stage.

A compressor must be operating for the condenser fans to operate. The definition of an operating compressor is a, compressor amps >= Low Amp limit or no amp sensor and compressor is in a running control state. The condenser relays (i.e. fans) will turn on based upon the value in setpoint STAGE 1 ON. When the discharge pressure exceeds this value, the first condenser relay is turned on. If additional condenser relays exist, they will be turned on when the pressure exceeds the previous cut in value (Stage 1 ON for the first stage) plus the value contained in STAGE DIFF ON setpoint.

Condenser relays (i.e. fans) will be turned off based upon the value in the setpoint STAGE 2 OFF (Stage 2 turn OFF point). As the discharge pressure is reduced, the condenser relay will be turned off based upon the STAGE 2 OFF setpoint, plus the value in STAGE OFF DIFF setpoint for each stage number above stage 2. Stage 1 of condenser staging will be turned off based upon the value in the setpoint (Stage 1 OFF).

Setpoint Information Screen														
#	Name	Value	Min	Max	Adjust Value	Time (SEC)	Max Time Allowed (SEC)	Lockout Delay (HRS)	Safety Down Time(MIN)	Active or Non-Active	Select Value: # decimals & print char	Level Of Auth. To Display	Type of Setpoint	
45	CND STG1 ON	200	190	220	0.5	0	1	0	0	Active	PSI GAGE	View Only	Setpoint	
46	CNC STG2 OFF	170	170	220	0.5	0	0	0	0	Active	PSI GAGE	View Only	Setpoint	
47	CND DIFF ON	20	10	50	1	0	0	0	0	Active	PSI GAGE	View Only	Setpoint	
48	CND DIFF OFF	10	5	50	1	0	0	0	0	Non-Active	PSI GAGE	View Only	Setpoint	
49	CND STG1OFF	175	170	195	0.5	0	0	0	0	Active	PSI GAGE	View Only	Setpoint	
50	CND TARG PSI	225	220	240	0.5	0	0	0	0	Active	PSI GAGE	View Only	Setpoint	

19.2.12.2. Adaptive Control Logic

The Adaptive Condenser logic is a self-learning fan control. The adaptive self-learning logic offers reduced fan cycling and improved efficiency. The Adaptive Condenser Control Logic automatically adjusts the fan cut-in offset based upon the following criteria:

1. If the last stage fan turned on (including stage 1) is cycled off in 10 minutes or less, then an Adaptive Offset value will be incremented by 5 PSI. This increases the stage 1 turn on value (“CND STG1 ON” plus Adaptive Offset) which in turn increases all the remaining fan on values. The Adaptive Offset will continue to increase, until fan cycling ceases or the adjusted turn on value for the last fan stage is greater than setpoint #50 “LastStgMax”.
2. The Adaptive Offset value will be decreased by 5 PSI if the last fan to be turned on has not cycled off within 1 hour. The Adaptive Offset will continue to decrease by 5 PSI every 10 minutes unless fan cycling begins again.

The Adaptive Control Logic will only affect the condenser fan turn on logic, it will not affect the fan turn off logic.

19.2.12.3. Adaptive Rotation Logic

The adaptive condenser logic can be setup to rotate the condenser fans based on first on/first off or the lead condenser fan can be forced to any one of the condenser fans. Setpoint #46 is used to setup/control the type of rotation.

If setpoint #46 is not setup as “TIME” type of setpoint no rotation is done and lead condenser fan is forced to the first condenser fan relay output.

If setpoint #46 is setup as a “TIME” type

- And the value of the “Time” column is Zero, then first on/first off rotation is performed. The rotation occurs when a fan is required to cycle off by the pressure cut out value.
- And the value of the “Time” column is greater than zero and less than the max condenser stages, the lead condenser fan is set to the value in the “Time” field. For example, if the time column contains a 2, then the lead condenser fan is the second condenser fan in the relay output sequence.
- And if the value if the “Time” column is greater than the max condenser stages, the lead condenser fan is force to first condenser fan in the relay output sequence.

19.2.12.4. Viewing on MCS-CONNECT and MCS-MAGNUM LCD KEYPAD

19.2.12.4.1. MCS-Connect Display

New columns in the compressor section are being added to the control status window where the adaptive offset values will be display.

System Status									
Capacity Control State	Time	Wanted/ Actual	Step Delay	Wanted %	Rate of Change	Control On	Mode	Ref Type	
UNIT IS HOLDING	00:04:12	0/0	180	0.0	0.0	ChlWtrOut= 46.0F	COOLING	R22	
State	Time	PSI Diff	FLA %	Steps	Lead?	Manual FLA %	Cond. Adap. Cut In Offset		
1)FAST UNLOADING	00:04:12	97.0P	78%	0	Yes	N/A	5.0P		
2)SAFETY TRIPPED	00:04:12	97.0P	78%	0		N/A	0.0P		
Suction Temp	Saturated Suction	Suction Superheat	Disc Temp	Saturated Discharge	Disc Superheat	Subcooling	Liquid Temp	Saturated Liquid Temp	
1) 45.0	33.7	136.3	152.0	101.3	50.7	-3.7	105.0F	101.3	
2) 50.0	33.7	136.3	152.0	101.3	50.7	-3.7	105.0F	101.3	

19.2.12.4.2. MCS-MAGNUM LCD KEYPAD

The adaptive Offset value can be viewed on the MCS-Magnum LCD/Keypad by selecting the “Status” option from the Menu screen. Once in the “Status” screens page down to the compressor 1st screen showing Compressor state, state timer, Suct, Disch, OPD, and Motor values. Then press the right arrow button one time to scroll over to view the AMPS. On the second line below the AMPS heading (not the first line below the heading which displays the comp amps) the Adaptive Offset value is displayed.



19.2.13 PID MOD Individual

Each compressor will have its own condenser Analog Outputs associated with it. The Analog Output for each circuit is modulated based on its own discharge pressure Rate of Change. It can also be controlled on a selected sensor input. You may also select Relay Outputs to be turned ON/OFF while modulating the Analog Output.

PID control will turn an analog output into a stand alone PID controlled output. This output will have a controlling sensor that modulates the AO to a maintain target. This logic will run all the time.

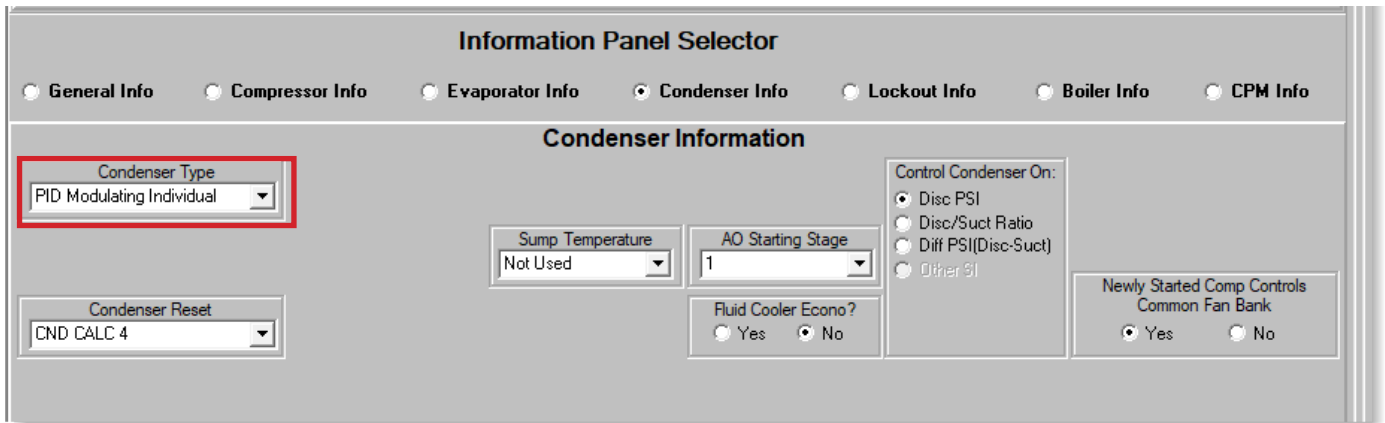

Setpoints used for PID Mod Individual and PID Step Common

45	CND STG1 ON (RO Type)	When the discharge pressure is above this value, turn on the first stage of the condenser fans. 'Time (sec)' field: (Applies to compressors with shared condensers) If non-zero, then the compressor in start-up state will not be in sole control of the condenser fans, it will control off of highest discharge pressure. If zero, then compressor in start-up will have sole condenser control for 5 minutes. This option is selected in the 'Newly started Comp Controls Common Fan Bank' box in the 'Condenser Information' panel under the MAGNUM screen.
	PID MOD Individual PID Step Common	If active, the value is the multiplier for the Proportional(Kp) adjustment, <u>Setup as Setpoint Type</u>
46	CND STG1 OFF (RO Type)	If stage 1 of condenser capacity is on and the discharge pressure drops below this value, then turn this stage off.
	PID MOD Individual PID Step Common	If active, uses Multiplier for Ki adjustments (Integral Time Delay). <u>Setup as Time Field</u>

47	CND DIFF ON (RO Type)	Differential pressure added to Setpoint #45 to set the threshold at which each additional stage of condenser capacity will turn on.
	PID MOD Individual PID Step Common	If active, use Multiplier for Kd adjustments, <u>Setup as Time Field-Time (sec) field is ROC window</u>
50	CND TRGT (Modulating Type)	Target logic will try to maintain modulating the AO. SP must be set up as target type and use the Hi/Low zones for the target control zone. If target type in Heat Pump mode, setback is added to target.
	LO AMB SUMP OFF (RO Type)	If active and ambient temperature is less than the value of this Setpoint, then the sump pump relay will be locked off if it is the starting condenser Relay Output. When the ambient temperature rises above the value of this Setpoint plus two times the value in Setpoint #192 "FRZ TEMP DIFF" if active (hard coded 15°F if inactive), then the sump pump relay will be allowed on again.
52	CND MIN % (Modulating Type)	Minimum AO % allowed. If compressor is off, then check the "Time (SEC)" field: If 0, then the AO % will be set to the value of this Setpoint. If 2 and the run/stop is set to run, then set the AO % to 100%, else set the AO % to 0%. This option is selected in the "Default Valve Opening % when Comp. is OFF" box in the condenser information section in the MAG HVAC screen.
55	CND MAX SPD (RO Type)	Maximum speed percentage for variable speed condenser control.
	CND MIN ADJ (Modulating Type)	The value in this Setpoint is the minimum % the AO will be modulated when a change is made.

Circuit Base settings

MAGNUM Circuit Base Screen													
Information that relates to Condensers and Evaporators on the circuit													
Circuit # [reset button]	# of Cond ROs	Starting Condenser RO	Condenser Fan AO	Starting Condenser Fault	# Cond Faults	Cond Fan Bank	Condenser Coil Temp #1	Condenser Coil Temp #2	Tandem EXV Circuit #	EXV #3 Circuit#	EXV #4 Circuit#	EXV #5 Circuit#	EXV #6 Circuit#
1	2	CND FAN1-1	CND1 VFD%	CND1 V FLT	1	1	CND1 COIL	Not Used	1	1	1	1	1
2	2	CND FAN2-1	CND2 VFD%	CND2 V FLT	1	2	CND2 COIL	Not Used	2	2	2	2	2

19.2.14 PID Step Common

This type of condenser has a common fan bank for the system. The control will be on the systems highest discharge pressure. The Relay Outputs are also supported along with an Analog Output.

PID control will turn an analog output into a stand alone PID controlled output. This output will have a controlling sensor that modulates the AO to a maintain target. This logic will run all the time.

Magnum HVAC Information Screen

Information Panel Selector

General Info
 Compressor Info
 Evaporator Info
 Condenser Info
 Lockout Info
 Boiler Info
 CPM Info

Condenser Information

Condenser Type: **PID Modulating Step Common**
 Starting Cond RO: Not Used
 # of Cond Stages: 0
 Fan AO: Not Used
 Control Condenser On:
 Disc PSI
 Disc/Suct Ratio
 Diff PSI(Disc-Suct)
 Other SI
 Cond Starting Fault: Not Used
 # of Cond Fault: 0
 Sump Temperature: Not Used
 Condenser Reset: Not Used
 Fluid Cooler Econo?: Yes No
 Newly Started Comp Controls Common Fan Bank: Yes No

19.3. PID CONTROL

- **Control Target**
SI, AO, or Setpoint used as the target the AO will try to maintain.
- **AO**
Min to Max value the AO can modulate between.
- **Proportional(Kp)**
Multiplier for Kp adjustments.
- **Integral(Ki)**
Multiplier and delay between Ki Adjustments.
- **Derivative(Kd)**
Multiplier and time in seconds interval to calculate Kd.
- **Adjustment Limits**
Min and Max adjustments allowed to the AO per adjustment, both negative and positive.

Under the Analog Outputs window in the MCS Connect software. You'll find an AO PID tab that will show all of the PID CONTROL AOs and all of the calculated adjustments being made to those Analog Outputs. Here you will be able to see all three adjustments being made to the PID. This will assist you in any fine tuning required for the given analog output.

AO #	Analog Outputs	Value	Manual Status	Total Adj.	Proportional Adj.	Integral Delay	Integral Adj.	Derivative Adj.
<input type="checkbox"/> M- 1	COMP1 SPD%	56.5%	AUTO	1773.2	138.94	0	131.25	138.74
<input type="checkbox"/> M- 2	COMP2 SPD%	56.5%	AUTO	1798.6	172.03	0	166.97	123.36
<input type="checkbox"/> M- 3	Exv#1-PID	42.3%	AUTO	1412.9	174.76	0	123.58	125.92
<input type="checkbox"/> M- 4	Exv#2-PID	51.0%	AUTO	1387.4	177.17	0	172.01	138.94
<input type="checkbox"/> 1-1	CND1 VFD%	100.0%	AUTO	261.8	166.94	0	177.18	133.60
<input type="checkbox"/> 1-2	CND2 VFD%	99.6%	AUTO	1233.6	174.57	0	146.59	126.00
<input type="checkbox"/> 1-3	WTR PUMP1%	0.0%	AUTO	1670.6	174.62	0	128.54	141.49
<input type="checkbox"/> 1-4	WTR PUMP2%	100.0%	AUTO	1745.9	169.44	0	123.55	138.94
<input type="checkbox"/> 2-1	SCEXV1-PID	0.0%	AUTO	1746.4	125.93	0	123.56	169.51
<input type="checkbox"/> 2-2	SCEXV2-PID	0.0%	AUTO	1414.9	128.54	0	179.89	174.62

Chapter - 20. Electronic Expansion Valve Control

20.1. Electronic Expansion Valve Control Logic (EXV)

The function of the thermostatic expansion valve is to hold a constant evaporator superheat.

The EXV is set up in MCS-Config as follows:

Relay Output Information Screen											
Number	Name	Slide Mult.	Slide Div.	Slide Off.	Design Suc.PSI	Design Dis.PSI	Nominal Tonnage(of Step)	EXV Start (When Lead)	Type	EXV Load Adjust %	EXV Unld Adjust %
M-1	COMP 1						0	28.5	Step w\ EXV		

For relay outputs for Type of Step w\ EXV:

'EXV Start (when Lead)' cell contains the EXV start percentage if this relay is the lead compressor.

'EXV Load Adjust %' cell contains the percentage of adjustment to the EXV when a step is added.

'EXV Unld Adjust %' cell contains the percentage of adjustment to the EXV when a step is deleted.

MAGNUM Circuit Base Screen

Information that relates to compressors on the circuit

Circuit # (reset button)	# of Comp ROs	Starting Compressor RO	Part Winding	Start Unload Bypass	Fast Unloader	Type of LLS	2nd LLS	Economizer	Econo Control	Unloading Stages	Loader Type	HGB	HG Reheat	Liquid Injection	Oil Equal
1	5	COMP 1	No	No	No	EXV&LLS	No	No	Slide %	0	Unloader	None	No	No	No
2	5	COMP 2	No	No	No	EXV&LLS	No	No	Slide %	0	Unloader	None	No	No	No
3	0	Not Used	No	No	No	None	No	No	Slide %	0	Unloader	None	No	No	No
4	0	Not Used	No	No	No	LLS only	No	No	Slide %	0	Unloader	None	No	No	No
5	0	Not Used	No	No	No	EXV&LLS	No	No	Slide %	0	Unloader	None	No	No	No
6	0	Not Used	No	No	No	EXV only	No	No	Slide %	0	Unloader	None	No	No	No
7	0	Not Used	No	No	No	None	No	No	Slide %	0	Unloader	None	No	No	No
8	0	Not Used	No	No	No	None	No	No	Slide %	0	Unloader	None	No	No	No

Select Output and Sensor Inputs per circuit

Circuit # (reset button)	Alarm Relay	Comp Proof	Compr Speed or Modulate Hot Gas AO	Compressor speed fault	Slide Closed Indicator	Pump Down	EXV Output	Flow	Circuit Pump/Valve	Lo Valve
1	Not Used	Not Used	Not Used	Not Used	Not Used	DISABLE 1	EXV1 %	Not Used	Not Used	Not Used
2	Not Used	Not Used	Not Used	Not Used	Not Used	DISABLE 2	EXV2 %	Not Used	Not Used	Not Used
3	Not Used	Not Used	Not Used	Not Used	Not Used	Not Used	Not Used	Not Used	Not Used	Not Used
4	Not Used	Not Used	Not Used	Not Used	Not Used	Not Used	Not Used	Not Used	Not Used	Not Used
5	Not Used	Not Used	Not Used	Not Used	Not Used	Not Used	Not Used	Not Used	Not Used	Not Used
6	Not Used	Not Used	Not Used	Not Used	Not Used	Not Used	Not Used	Not Used	Not Used	Not Used
7	Not Used	Not Used	Not Used	Not Used	Not Used	Not Used	Not Used	Not Used	Not Used	Not Used
8	Not Used	Not Used	Not Used	Not Used	Not Used	Not Used	Not Used	Not Used	Not Used	Not Used

Information that relates to condensers on the circuit

Circuit # (reset button)	# of Cond ROs	Starting Condenser RO	Condenser Fan AO	Starting Condenser Fault	# Cond Faults	Cond Fan Bank	Condenser Coil Temp #1	Condenser Coil Temp #2	Tandem EXV Circuit #	EXV Control	Suction Group	Comp Name/ID
1	5	CndFan 1-1	Not Used	Not Used	0	1	Not Used	Not Used	1	Suct Spht	1	1
2	5	CndFan 2-1	Not Used	Not Used	0	2	Not Used	Not Used	2	Ref Lvl	2	2

Purge Relays and Sensors

Circuit # (reset button)	Purge Enable RO	Purge Solenoid RO	Purge Exhaust Pump RO	Purge Mode Switch SI	Purge Safety Switch SI	Purge Suction Temp SI	Regeneration Solenoid Valve	Regeneration Carbon Heater	Regeneration Carbon Tank Temp
1	Not Used	Not Used	Not Used	Not Used	Not Used	Not Used	Not Used	Not Used	Not Used
2	Not Used	Not Used	Not Used	Not Used	Not Used	Not Used	Not Used	Not Used	Not Used
3	Not Used	Not Used	Not Used	Not Used	Not Used	Not Used	Not Used	Not Used	Not Used
4	Not Used	Not Used	Not Used	Not Used	Not Used	Not Used	Not Used	Not Used	Not Used
5	Not Used	Not Used	Not Used	Not Used	Not Used	Not Used	Not Used	Not Used	Not Used
6	Not Used	Not Used	Not Used	Not Used	Not Used	Not Used	Not Used	Not Used	Not Used
7	Not Used	Not Used	Not Used	Not Used	Not Used	Not Used	Not Used	Not Used	Not Used
8	Not Used	Not Used	Not Used	Not Used	Not Used	Not Used	Not Used	Not Used	Not Used

MCS-MAGNUM EXV SUCTION/DISCHARGE SUPERHEAT LOGIC

MCS-MAGNUM EXV Setpoints

#9 SUPERHT TARG = Target temperature setting for Superheat ('Time (sec)' is the seconds between samples used for calculating the Superheat Rate of Change).

#10 SPRHT ZONE+- = This value is added to and subtracted from setpoint #9 to calculate the upper and lower zones of the superheat control zone.

#11 EXV LOAD ADJ = The opening adjustment that will be made to the EXV when the compressor load solenoid is pulsed, or the closing adjustment when the compressor unload solenoid is pulsed.

#12 EXV FINE ADJ = Small Adjustment for the Valve (See Chart).

#13 EXV COURSE = Large Adjustment for the Valve (See Chart).

#14 EXV LOAD DIV = As the compressor amp draw % changes, this divides the EXV % change. It is calculated as follows: (Last FLA % - Current FLA %)/Setpoint #14

#15 EXV MIN% = Minimum Valve % allowed.

#16 EXV MAX% = Maximum Valve % allowed.

#17 LO SUPERHEAT = Temperature setting for Low Superheat.

#18 LOSUCTPSIDLY = Delay (sec) when in Lo Suct PSI Opening

#19 EXV DELAY = Maximum Delay (sec) between valve adjustments.

#20 EXV STRT TME = Delay (sec) to remain in EXV IN STARTUP when the compressor first starts.

#65 EXV ZONE1 DB = When set up as a setpoint or target type, the value field is added to and subtracted from setpoint #9 "Superheat Target" \pm setpoint #10 "Superheat zone" to develop the upper and lower limits for "EXV is Opening" and "EXV is Closing" zones in zone 1. When set up as a target, the night setback field is used as an offset that is added to setpoint #9 (Superheat Target) to calculate the bottom value for the limit of where Low PSI opening is allow to operate.

#66 EXV ZONE2 DB = The offset added to and subtracted from setpoint #9 "Superheat Target" \pm (setpoint #10 "Superheat zone" \times 2 OR setpoint #65 "EXV ZONE1 DB" if active) to develop the upper and lower limit for "EXV Opening 2x" and "EXV Closing 2x" zones in zone 2.

#67 EXV ROC ZN1 = The superheat's Rate Of Change (ROC) holding limit for the "EXV Opening" and "EXV Closing" zone. This setpoint value is entered as a positive number and for "EXV is Opening" zone multiplied by -1. Time in seconds = Minimum time to hold when outside the zone and the ROC is moving in the right direction. The EXV will be forced into a hold state for this minimum time.

#69 EXV ROC ZN2 = The superheat's Rate Of Change (ROC) holding limit for the "EXV Opening 2x" and "EXV Closing 2x" zone. The setpoint value is entered as a positive number and for "EXV Opening 2x" zone multiplied by -1. Time in seconds = Minimum time to hold when outside the zone and the ROC is moving in the right direction. The EXV will be forced into a hold state for this minimum time.

#70 EXV ROC ZN3 = The superheat's Rate Of Change (ROC) holding limit for the "EXV Opening 4x" and "EXV Closing 4x" zone. The setpoint value is entered as a positive number and for "EXV Opening 4x" zone multiplied by -1. Time in seconds = Minimum time to hold when outside the zone and the ROC is moving in the right direction. The EXV will be forced into a hold state for this minimum time.

#71 EXV ROC HD2x = The superheat ROC Opening 2x/Closing 2x limit for the "EXV is HOLDING" zone. The setpoint value is entered as a positive number and for "EXV Opening 2x" tested multiplied by -1. Time in seconds = Minimum time to hold when outside the zone and the ROC is moving in the right direction. The EXV will be forced into a hold state for this minimum time.

#72 EXV ROC HD1x = The superheat ROC Opening/Closing limit for the "EXV is HOLDING" zone. The setpoint value is entered as a positive number and for "EXV Opening" zone multiplied by -1.

#77 LOW SUCTION = Low suction PSI safety (See chart for calculation).

#78 LO SUCT UNLD = Time value is used to delay the comp from going into safety unloading state to allow EXV time to open.

#79 LO SUCT RELD = Low suction reloading (See chart for calculation).

MICRO CONTROL SYSTEMS Inc.	
DATE:	07-23-12 Page 1 of 3
DRAWN BY:	M. Schreiber
REVISION :	G
DWG NAME:	MCS-MAGNUM EXV SUCTION-DISCHARGE SUPERHEAT LOGIC - REV G.DWG

MCS-MAGNUM EXV SUCTION/DISCHARGE SUPERHEAT LOGIC

MCS-MAGNUM EXV Setpoints

#199 MOP TARG PSI = The Maximum Operation Suction pressure (MOP). If the suction pressure is greater than this value plus setpoint #200, then the EXV is forced to close. The EXV state is set to "EXV IS MOP CLS".

#200 MOP PSI ZONE = If the suction pressure is greater than setpoint #199 minus this value, then the EXV is force into "EXV IS MOP HLD" and the EXV will not be allowed to open.

#201 MOP ADJ % TME = This setpoint's value is used as the amount to adjust the EXV closed when in "EXV IS MOP CLS". This setpoint's "Time in sec" column is used as the delay between EXV adjustments when in the "EXV IS MOP CLS" state.

#205 EXV MDP = The Minimum Oil Differential pressure limit. When oil differential is below this value the EXV state will go to "EXV is MDP CLS". The setpoint's 'Time (sec)' column is an offset pressure value to allow the EXV back to normal control (Value is entered with one assumed decimal place. Ex: value of 50 = 5.0 psi offset). The 'Sec. To Ignore Safety' column is the time in minutes for the MDP logic to run after the compressor starts; if zero then MDP logic will run all the time. The 'Lockout Delay Hrs.' column is the adjust amount the EXV will be closed each time the delay reaches zero (Value is entered with one assumed decimal place. Ex: value of 20 = 2.0%).

EXV STARTING % is stored in RO Grid in Compressor row.

MICRO CONTROL SYSTEMS Inc.	
DATE:	07-23-12 Page 2 of 3
DRAWN BY:	M. Schreiber
REVISION :	G
DWG NAME:	MCS-MAGNUM EXV SUCTION-DISCHARGE SUPERHEAT LOGIC - REV G.DWG

Legend:

Calculated
Zone Limit

EXV State = Adjustment to EXV when delay reaches 0, Adjustment to delay every second
Superheat Rate of Change requirement to stay out of HOLD state

If Superheat exceeds the Calculated Zone Limit and the Rate of Change requirement is satisfied then EXV State, EXV Adjust, and Delay Adjust will all equal the corresponding values in the chart below. If those conditions are not met, the EXV state will be set to HOLD.

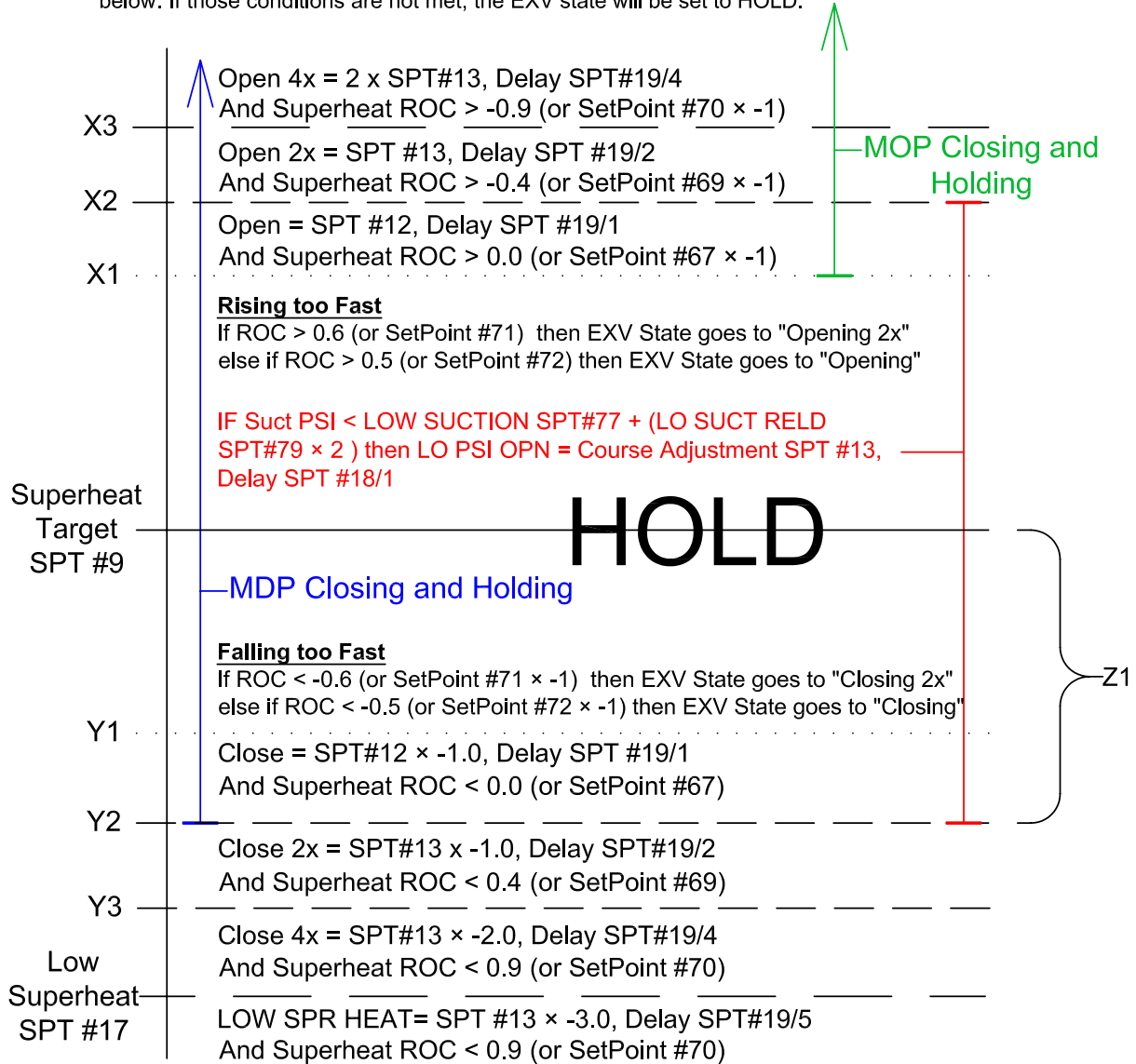

X1 = Stpt #9 + Stpt #10

Y1 = Stpt #9 - Stpt #10

X2 = X1 + Stpt #10

Y2 = Y1 - Stpt #10

or if Setpoint #65 is active
then X2 = X1 + Stpt #65

or if Setpoint #65 is active
then Y2 = Y1 - Stpt #65

X3 = X2 + Stpt #10

Y3 = Y2 - Stpt #10

or if Setpoint #66 is active
then X3 = X2 + Stpt #66

or if Setpoint #66 is active
then Y3 = Y2 - Stpt #66

Z1 = If setpoint #65 is not defined as a "TARGET" type then Y2 is the bottom limit where "LO PSI OPN" logic is allowed to work.

If setpoint #65 is defined as a "TARGET" type then setpoint #65 night setback field is added to setpoint #9 valve to calculate the bottom limit where "LO PSI OPN" logic is allowed to work.

MICRO CONTROL SYSTEMS Inc.	
DATE:	07-23-12 Page 3 of 3
DRAWN BY:	M. Schreiber
REVISION :	G
DWG NAME:	MCS-MAGNUM EXV SUCTION-DISCHARGE SUPERHEAT LOGIC -REV G.DWG

20.1.1 EXV Control States

The EXV Control States show the status of the compressor's expansion valve. If the compressor has an EXV it will be displayed under the Status entry.

Capacity Control State	Time	Wanted/ Actual	Step Delay	Wanted %	Rate of Change	Control On	Mode
UNIT IS HOLDING	00:00:16	1/1	60	100.0	0.0	ChlWtrOut= 55.0F	COOLING
State	Time	Oil Diff	FLA %	Steps	Lead?		
1)FAST UNLOADING	00:00:14	140.0P	97	1	Yes		
2)SAFETY TRIPPED	00:01:15	156.0P	116	0			
Suction Temp	Saturated Suction	Suction Superheat	Disc Temp	Saturated Discharge	Disc Superheat	Ref Type	
1) 45.0	33.0	12.0	152.0	100.6	51.4	R22	
2) 50.0	38.1	11.9	185.0	102.9	82.1	R22	
Valve State	Time	Valve %	SuperHeat	SuperHeat ROC	ADJ Delay		
1) EXV PRE-PMPDWN	00:00:16	15.0	12.0	0.0	0		
2) EXV IS CLOSED	00:01:16	0.0	11.9	0.0	0		

To view the EXV status through the Keypad LCD, select Status from the Main Menu and then page to the EXV screen.

EXV States:

LOCKED OUT	The compressor is in a Lockout state.
IS CLOSED	The associated compressor is OFF and the valve is closed
PRE-PMPDWN	The valve has been in a closed state and the system is now requiring the valve action.
IN STARTUP	At startup the valve will remain in this state for the time in Setpoint #20. At that time the state will be changed to holding, at this point the valve control logic will position the valve.
AT 100%	This state will be entered when the valve opening reaches 100%.
IS HOLDING	Refer to EXV Logic Chart, superheat is in control zone and ROC is acceptable.
IS OPENING	Refer to EXV Logic Chart, superheat is in control zone but rising too fast, ROC less than 1.0.
IS CLOSING	Refer to EXV Logic Chart, superheat is in the control zone and the rate of change is acceptable, ROC greater than -0.5.
LOW SPRHT	Refer to EXV Logic Chart, force a course valve adjustment.
OPENING 4x	Refer to EXV Logic Chart, superheat is above control zone.
OPENING 2x	Refer to EXV Logic Chart, superheat is in control zone but rising too fast, the ROC is greater than 1.0.
LO PSI OPN	Refer to EXV Logic Chart, state indicates that a low suction pressure condition exists. The suction pressure is less than Setpoint #77 "LOW SUCTION" plus twice the value of Setpoint #79 "LOW SUCT RELOAD" and the superheat is greater than Setpoint #9 "SUPERHT TRGT" plus twice the value of Setpoint #10 "SPRHT ZONE+."
CLOSING 2x	Refer to EXV Logic Chart, superheat is in the control zone and the rate of change is acceptable, the ROC is less than -0.5 and greater than -1.0.
CLOSING 4x	Refer to EXV Logic Chart, superheat is in control zone but falling too fast, ROC less than -1.0.
HI LVL CLS	This state indicates that a high refrigerant level. This state is entered if Setpoint #109 "HiRefLevel" is active and the superheat is greater than the value of this Setpoint.
IS MOP CLS	Refer to EXV Logic Chart. Maximum operating pressure option is active and it is forcing the EXV to close. In this state the EXV valve's opening will be reduced.
IS MOP HLD	Refer to EXV Logic Chart. Maximum operating pressure option is active and it is forcing the EXV to hold.

20.1.2 EXV Maximum Operating Pressure

Setpoint #199 “MOP TARG PSI” must be active if the suction pressure is to be checked for maximum operating pressure.

If the suction pressure is above the MOP control zone, then the EXV state will be changed to EXV IS MOP CLS. The EXV valve opening will be closed by the value in Setpoint #201 with each adjustment. The ‘Time(sec)’ field of Setpoint #201 will be the delay between making adjustments to the EXV valves. The EXV will remain in this state until the suction pressure drops below the top of the MOP control zone. At this point the state will be changed to EXV IS MOP HOLD.

In the EXV IS MOP HOLD state the EXV valve’s opening cannot be increased but it can be closed. The EXV will remain in this state until the suction pressure drops below the MOP control zone. At that time the EXV control state will change to EXV IS HOLDING and normal EXV control will resume.

(Refer to section 13 Setpoints #199, #200, and #201)

20.1.3 Tandem EXV Setup

The Magnum supports tandem EXV control. However a separate compressor must be set up to support this function. Therefore, the maximum compressors that can be supported with tandem EXV are ten. The tandem EXV compressors must follow the active compressors in the system.

20.1.4 Example: One Compressor with One Step and Tandem EXV’s

In the General Information panel of the MAGNUM screen enter the number of compressors and steps:

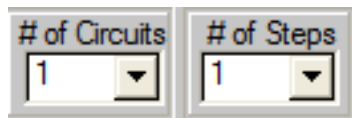

In the Circuit Base screen the base compressor information will be entered. The active compressors information is to be completed as normal and the tandem EXV information will be provided as needed. Note the Type of LLS cell must be ‘EXV&LLS’ for the active compressor and ‘EXV only’ for the tandem compressor.

Information that relates to compressors on the circuit													
Circuit # (reset button)	# of Comp ROs	Starting Compressor RO	Part Winding	Start Unload Bypass	Fast Unloader	Type of LLS	2nd LLS	3rd LLS	3rd LLS Control	Unloading Stages	Loader Type	HGB	HG Reheat
1	2	COMP	No	No	No	EXV&LLS	No	No	Slide %	0	Unloader	None	No
2	0	Not Used	No	No	No	EXV only	No	No	Slide %	0	Unloader	None	No

In the next section the EXV Output cell must be set up for both the EXV’s

Select Output and Sensor Inputs per circuit								
Circuit # (reset button)	Alarm Relay	Comp Proof	Compr Speed or Modulate Hot Gas AO	Compressor speed fault	Slide Closed Indicator	Pump Down	EXV Output	
1	Not Used	Not Used	Not Used	Not Used	Not Used	Not Used	EXV A	
2	Not Used	Not Used	Not Used	Not Used	Not Used	Not Used	EXV B	

In the next section the active compressor is associated with its tandem EXV in the ‘Tandem EXV Circuit #’ cell. Circuit #1 ties to circuit #2, this is the tandem EXV. The Suction Group cells are 1 and 2 respectively.

Information that relates to condensers on the circuit											
Circuit # (reset button)	# of Cond ROs	Starting Condensator RO	Condensator Fan AO	Starting Condensator Fault	# Cond Faults	Cond Fan Bank	Condenser Coil Temp #1	Condenser Coil Temp #2	Tandem EXV Circuit #	EXV Control	Suction Group
1	0	Not Used	Not Used	Not Used	0	1	Not Used	Not Used	2	Superht	1
2	0	Not Used	Not Used	Not Used	0	1	Not Used	Not Used	2	Superht	2

In the Compressor SI screen the active compressors information is to be completed as normal, while only the Suction Pressure and Suction Temperature must be entered for the tandem EXV. The different suction temperature provides separate control for the tandem EXV.

20.1.4.1. Example: Two Compressors with Four Steps and Tandem EXV's
 In the General Information panel of the MAGNUM screen enter the number of compressors and steps:

of Circuits

of Steps

Information that relates to compressors on the circuit																		
Circuit # (reset button)	# of Comp ROs	Starting Compressor RO	Part Winding	Start Unload Bypass	Fast Unloader	Type of LLS	2nd LLS	3rd LLS	3rd LLS Control	Unloading Stages	Loader Type							
▶ 1	...	3	COMP 1	No	...	No	...	No	...	EXV&LLS	No	...	No	...	Slide %	...	1	Unloader
2	...	3	COMP 2	No	...	No	...	No	...	EXV&LLS	No	...	No	...	Slide %	...	1	Unloader
3	...	0	Not Used	No	...	No	...	No	...	EXV only	No	...	No	...	Slide %	...	0	Unloader
4	...	0	Not Used	No	...	No	...	No	...	EXV only	No	...	No	...	Slide %	...	0	Unloader

In the next section the EXV Output cell must be set up for all the EXV's

Select Output and Sensor Inputs per circuit								
Circuit # (reset button)	Alarm Relay	Comp Proof	Compr Speed or Modulate Hot Gas AO	Compressor speed fault	Slide Closed Indicator	Pump Down	EXV Output	
▶ 1	...	Not Used	Not Used	Not Used	Not Used	Not Used	DISABLE1	EXV1A%
2	...	Not Used	Not Used	Not Used	Not Used	Not Used	DISABLE2	EXV2A%
3	...	Not Used	Not Used	Not Used	Not Used	Not Used	Not Used	EXV1B%
4	...	Not Used	Not Used	Not Used	Not Used	Not Used	Not Used	EXV2B%

In the next section the active compressor is associated with its tandem EXV in the 'Tandem EXV Circuit #' cell. Circuit #1 ties to circuit #3, and circuit #2 ties to circuit #4 (circuits #3 and #4 are the Tandem EXV's). The Suction Group cells are 1, 2, 3, and 4 respectively.

In the Compressor SI screen the active compressors information is to be completed as normal, while only the Suction Pressure and Suction Temperature must be entered for the tandem EXV's. The different suction temperature provides separate control for the tandem EXV's.

Information that relates to condensers on the circuit												
Circuit # (reset button)	# of Cond ROs	Starting Condensor RO	Condensor Fan AO	Starting Condenser Fault	# Cond Faults	Cond Fan Bank	Condenser Coil Temp #1	Condenser Coil Temp #2	Tandem EXV Circuit #	EXV Control	Suction Group	
▶ 1	...	2	FAN 1-1	Not Used	Not Used	0	1	Not Used	Not Used	3	Superht	1
2	...	2	FAN 2-1	Not Used	Not Used	0	2	Not Used	Not Used	4	Superht	2
3	...	0	Not Used	Not Used	Not Used	0	3	Not Used	Not Used	3	Superht	3
4	...	0	Not Used	Not Used	Not Used	0	4	Not Used	Not Used	4	Superht	4

Select Suction, Discharge, Oil and Motor Sensors for Circuits									
Circuit # (reset button)	Suction Pressure	Discharge Pressure	Suction Temperature	Discharge Temperature	Oil Pressure	Oil Temp	Motor Amps	Motor Temp	
▶ 1	...	SUCT PSI	DISC PSI	EVP TmpA	DISC TMP	OIL PSI	Not Used	AMPS	MTR FLT
2	...	SUCT PSI	Not Used	EVP TmpB	Not Used	Not Used	Not Used	Not Used	Not Used

20.1.5 'Evaporator or Condenser Refrigerant Level Control

There is an alternate method to control the EXV based on Ref Level.

20.1.5.1. Minimum Refrigerant Level target (HVAC ONLY)

If active and the EXV is controlled by Refrigerant Level, then a new variable level target logic will be activated. As the unit capacity increases, the refrigerant level target will change according to a linear calculation between Setpoint #9 "LEVEL TARGET" (the maximum target level) and Setpoint #217 "LOW EXV TARGET" (the minimum target level). This relationship is explained in the following graph:

In the Compressor SI screen the active compressors information is to be completed as normal, while only the Suction Pressure and Suction Temperature must be entered for the tandem EXV's. The different suction temperature provides separate control for the tandem EXV's.

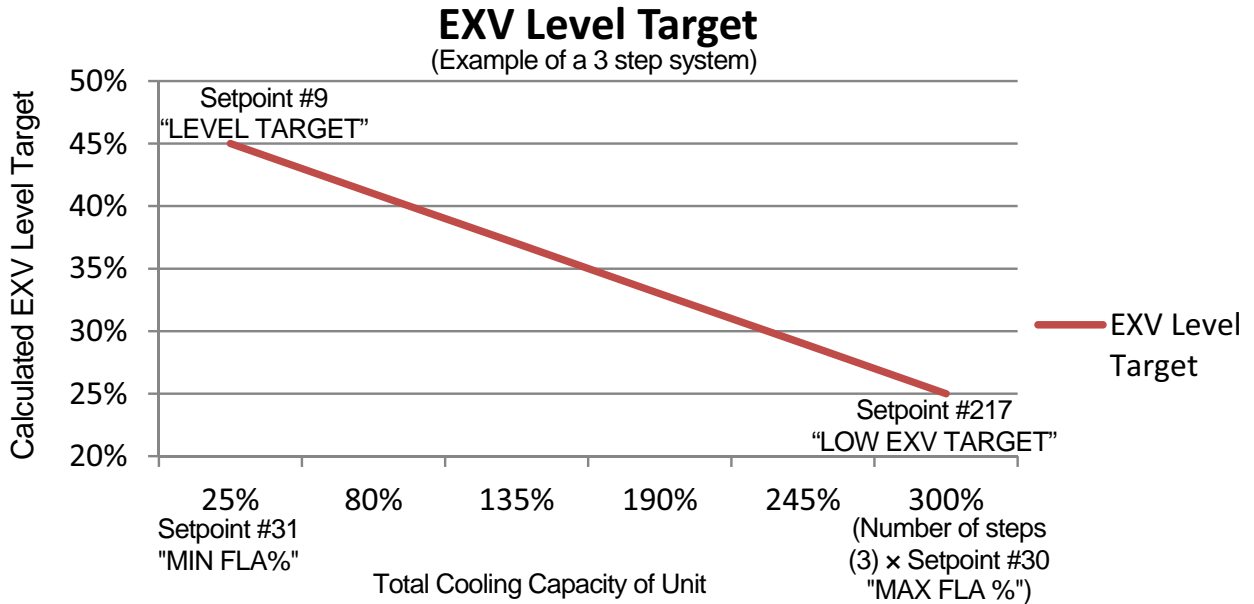

20.1.5.2. Evaporator Level Control

This option will control the EXV based upon the Refrig Level sensor which is selected in Circuit SI screen, column Refrig Level. Control will be as indicated in the MCS-MAGNUM EXV SUCTION/DISCHARGE SUPERHEAT LOGIC sections except the EXV states will be the opposite of the SUCTION/DISCHARGE control. When the refrigerant level is above the associated control point the EXV valve will be closed and when it is below the associated control point the EXV valve will be opened.

20.1.5.3. Condenser Level Control

This option will control the EXV based upon the Refrig Level sensor which is selected in Circuit SI screen column Refrig Level. This sensor will indicate the refrigerant level in the condenser. Control is the opposite of the Refrigerant Level Control. When the condenser level is above the associated control point the EXV valve will be opened and when it below the associated control point the EXV valve will be closed.

20.1.6 EXV control methods for Step Loading Compressors

Percentage per Step: (Requires Magnum Software HVAC 8.03L and MCS-Config 8.00W or higher)

To control the EXV based on a percentage per step for fixed step compressors, insert the relative load and unload adjustment percentages in the respective fields in the Relay Output screen. The load and unload adjustments will increase or decrease respectively based on a percentage of the current EXV position (not a fixed value)

Here is an example of a Hanbell Screw compressor configured to load by fixed steps:

Relay Output Information Screen						
Number	Name	EXV Start (When Lead)	Type	EXV Load Adjust %	EXV Unld Adjust %	Comments
M-1	COMP 1	25	Step w\ EXV	50	60	
M-2	LLS 1	-----	Standard	-----	-----	
M-3	HotGasByps	0	Step w\ EXV	50	60	
M-4	UNLOAD 50%	0	Step w\ EXV	30	40	
M-5	UNLOAD 75%	0	Step w\ EXV	20	30	

These columns are used for the compressor when there are multiple compressors on a single suction circuit, however, values must be in these fields for this logic to be in effect.

The logic will work as follows: When the compressor starts the EXV will go to the value in the 'EXV Start (when lead)' column, in this example it is 25%. The EXV will then modulate normally according to the controlling superheat or refrigerant level, until the unit is ready to load another step of capacity. Assume the EXV has stayed at 35% when the second step of capacity is ready to engage (turning off the Hot Gas Bypass). The EXV adjustment will be 50% (the amount in the 'EXV Load Adjust' column of the current EXV position

'EXV Load Adjust' column (50%) × current EXV position (35%) = EXV adjustment (17.5%)

$$50\% \times 35\% = 17.5\%$$

Current EXV position (35%) + EXV adjustment (17.5%) = New EXV position (42.5%)

$$35\% + 17.5\% = 42.5\%$$

Therefore the final EXV valve position would be 42.5%

This same calculation will be repeated every time a new stage of capacity is turned on. Conversely, when the unit is unloading, the EXV adjustment will be subtracted from the current EXV position for every step that turns off. Assume the EXV is at 40% and the compressor is at 100% and is ready to unload a step (turning on Unload 75% solenoid).

'EXV Unld Adjust' column (30%) × current EXV position (40%) = EXV adjustment (12%)

$$30\% \times 40\% = 12\%$$

Current EXV position (40%) – EXV adjustment (12%) = New EXV position (28%)

$$40\% - 12\% = 28\%$$

Therefore the final EXV valve position would be 28%

The values given in the example are only start points. You will need to adjust the values for your system. The idea is to jump the EXV position so that the superheat would still be above the target slightly, and then the EXV control logic would then adjust the value to achieve the target superheat. We do not want to open the EXV valve too much when loading or close the valve too much when unloading so we do not cause low superheat or liquid flooding to the compressor.

Chapter - 21. Sub Cooler EXV Control Logic

Purpose of Change

The purpose of this change is to add Electronic Expansion Valve (EXV) control logic for Subcooler heat exchanger(s). There can be a subcooler for each refrigeration circuit. If there are multiple compressors on the refrigeration circuit the logic will need to control the EXV when any compressor on the refrigerant circuit is running.

21.1. New Sensor Inputs

Subcooler Suction PSI – Analog sensor input which indicates the suction pressure on the subcooler heat exchanger. This will be the refrigerant gas going to the compressor's economizer port (vapor injection port). There will be one suction pressure per refrigerant circuit.

Subcooler Suction Temperture – Analog sensor input which indicates the suction temperature on the subcooler heat exchanger. This will be the refrigerant gas temperature going to compressor's economizer port (vapor injection port). There will be one suction temperature per refrigerant circuit.

21.2. New Analog Outputs

Subcooler Electronic Expansion Valve – analog output used to control the position of the electronic expansion valve. This must be connected to device (MCS-EXV-DRVIER) to move the EXV. There will be one analog output per refrigerant circuit.

21.3. Existing Relay Outputs

Economizer Solenoid Valve – relay output used to stop the refrigeration gas flow to compressor economizer port (vapor injection port). There will be one relay output per compressor.

If there is only one compressor on the refrigerant circuit and the EXV is capable of closed upon loss of powers, the economizer solenoid valve relay output is optional because the EXV can act as the solenoid valve.

If there are multiple compressors on the refrigerant circuit, then solenoid valve is not optional, no matter what type of EXV. And each compressor will have its own relay output to control its own solenoid valve.

21.4. Calculated Values

Subcooler Saturated Suction Temperature – This value is calculated using the subcooler suction pressure and refrigerant's Pressure to Temperature chart. The subcooler suction pressure is used as the input into the refrigerant's pressure to temperature chart to find the saturated temperature.

Subcooler Superheat Temperature – This value is calculated by subtracting the Subcooler Saturated Suction Temperature from the Subcooler Suction Temperature.

$$\text{Subcooler Superheat} = \text{Subcooler Suction Temperature} - \text{Subcooler Saturated Suction Temperature}$$

Subcooler EXV State – This value is determined by the logic to control the EXV.

Subcooler Time Delay – This value is calculated by the control logic and is used to delay adjustments to the EXV position.

Subcooler Wanted Position – This value is calculated by the control logic is the wanted position of the EXV.

Subcooler Superheat ROC – This value is calculated by the control logic. It is the superheat Rate of Change. It is calculated by subtracting the current superheat value from a previous superheat value. The control logic will need to store the last 60 superheat values.

21.5. New Config Parameters

New setpoints required to control the Subcooler EXV:

1. Subcooler SuperheatTarget – this setpoint define the superheat target the control logic will maintain.
2. Subcooler deadband – this setpoint define the deadband around the superheat target. This setpoint with the target setpoint defines the control zone for subcooler superheat.
3. Subcooler delay – This is the delay between adjustments to the EXV position.
4. Subcooler EXV starting % - This is the start position for the EXV when the subcooler is first turned on.
5. Subcooler EXV starting time – This is the time to remain at the starting EXV position to allow for the subcooler superheat to develop to a real value to control the EXV.
6. All the EXV setpoints? Fine, course, low superheat, MOP, low suction, min/max EXV allowed?
7. MOP, Low suction psi, low suction control setpoints (delay, adjustment multiplier), Others?

21.6. Logic Requirements

1. Subcooler EXV control logic needs to run once a second.
2. There can be only one subcooler heater exchanger per refrigerant circuit. The subcooler heat exchange is an optional feature and maybe not be installed.
 - a. If there is only one compressor on the refrigerant circuit then only when the one compressor is running does the subcooler control logic run to maintain the superheat. And there will be one EXV AO, one Suction Pressure SI, one Suction Temperature and one optional economizer solenoid valve RO. The economizer solenoid valve RO is optional only if the EXV driver can closed the valve on loss of power (EXV acts as solenoid valve – therefore a solenoid valve is not required).
 - b. If there are multiple compressors on the refrigerant circuit then when any compressor on the suction group is running the Subcooler EXV logic need maintain the superheat target. And there will be one EXV AO, one Suction Pressure SI, one Suction Temperature and multiple economizer solenoid valve ROs (one RO per compressor). And the RO is not optional, because we need to turn on solenoid valves for only the compressors that are running on the refrigerant circuit. Compressors not running will have the solenoid valves off.
3. Suggest similar Subcooler EXV state as Evaporator EXV state
 - a. Subcooler EXV LOCKED OUT
 - b. Subcooler EXV CLOSED
 - c. Subcooler EXV Holding
 - d. Subcooler EXV in Startup
 - e. Subcooler EXV Opening 1x
 - f. Subcooler EXV Opening 2x
 - g. Subcooler EXV Opening 4x
 - h. Subcooler EXV Closing 1x
 - i. Subcooler EXV Closing 2x
 - j. Subcooler EXV Closing 4x
 - k. Low Superheat Closing
 - l. MOP Closing, MOP Holding, Low Suction Opening?
 - m. Others?
4. If all the compressors are off:
 - a. The Subcooler EXV analog output is forced to 0.0%
 - b. The Economizer solenoid valve RO is turned off.
 - c. The subcooler control variables, step delay, etc are reset to defaults.
 - d. The state is set to Subcooler EXV Closed.
5. Once any compressor is started and either it's FLA% is greater than setpoint #?? Or the setpoint #?? Is inactive then::
 - a. The Subcooler state is moved from EXV CLOSED to Subcooler EXV in Startup. The subcooler will remain in this state for X seconds (X defined by setpoint valve) with the EXV AO set to percentage

defined by setpoint value. And the compressor solenoid RO is turned on (if one exists).

- b. Once the Startup time delay is satisfied the EXV state will be change to Subcooler Holding and EXV AO will be modulated to maintain the superheat within the control zone and the following logic run:
 - i. If the Subcooler Suction pressure is greater than or equal to the MOP setpoint the state will be set to MOP Closing.
 - ii. If the Subcooler Suction pressure is less than low suction pressure setpoint and the subcooler superheat is in or above control zone the state will be set to Low Suction Opening and the valve will be quickly open.
 - iii. If the Subcooler superheat is within the control zone or ROC is satisfied then state will remain in Subcooler Holding.
 - iv. If the subcooler superheat is above the control zone:
 1. And the ROC is above the ROC- setpoint, the will be set based upon how far above the control zone, Opening 1x, Opening 2x, Opening 4x.
 2. Else if ROC is equal to or below ROC- setpoint then state is set to EXV HoLDING.
 - v. If the subcooler superheat is below the control zone
 1. And superheat ROC is greater than the ROC+ setpoint, the state will be set based upon how far below the control zone, Closing 1x, Closing 2x, Closing 4x.
 2. Else if ROC is rqual to or greater than ROC+ setpoint, the state will be set to ECV HoLDING.
 - vi. The EXV time delay needs to be decrement each second by a variable amount determine by subcooler state until the delay reaches zero. The further away from the target the bigger the adjustment to allow changes faster. Once the delay reaches zero:
 1. If the superheat is inside the control:
 - a. If ROC is between the ROC+ and ROC- setpoint values, then EXV state goes to holding.
 - b. If ROC less than ROC- setpoint then exv states goes to Closing 1x.
 - c. If ROC greater than ROC+ setpoint value then exv state goes to Opening 1x.
 2. if a superheat is outside the control zone then a variable adjustment will be made the Subcooler wanted position. The further away from the target the bigger the adjustment to move the valve faster. And if above the control zone the adjustment will be added to the current wanted % to open the value. If below the control zone the the adjustment will be subtracted to the current wanted % to close the valve. The wanted % is bound-ed by min and max limits defined by new setpoint values in the config.
 3. Last comp on refrigerant circuit is turn off or last econo turn off? Then subcooler exv state goes to exv closed.

Chapter - 22. EXV Control SSH, SSH2

MCS has released two new superheat control systems in addition to its existing EXV Superheat Control Systems.

22.1. Fast Suction Superheat (Fast SSH)

Released with firmware 17.26-B.hex with the following objectives:

- Reduce the number of set points required. (SP 65 through 72 were eliminated)
- Provide only one control zone.
- Anytime the superheat moves outside this zone to recovery within two minutes or less.
- Provide Fast Suction Superheat control for Subcooler's with standard set points.
(SP 65 through 72 were used. (SP 253 through 255 were eliminated)

Provide option to dynamically calculate the EXV starting position

22.2. Fast Suction Superheat 2 (Fast SSH2)

Released with firmware 17.37D1.hex with the following objectives:

- Provide MCS Default set points for all EXV controls types.
- Improve on self learning EXV Valve starting position.
- Provide color coded identification for Fast SSH, Fast SSH2 & Subcooler options in MCS-Config.
- Add an extended SH ROC to allow finer decisions and reduce valve movement.
- Add explicit states for Fast SSH and Fast SSH2.

22.3. Selecting Fast SSH or Fast SSH2 in MCS-Config

In Fast SSH & Fast SSH2 only Set Points 9 through 20 are used to control the EXV valve. If you select Fast SSH or Fast SSH2 as your superheat EXV control and you have a subcooler (an economizer injecting refrigerant into the compression chamber) you will get Fast SSH control on the EXV for the subcooler. The Fast SSH set points for the subcooler are 65 through 72.

Select Type of Control in Relay Output Information Screen. In the RO screen, from the drop down window in 'Type' you select either 'Step w \ EXV' or 'Screw w \ EXV'

Relay Output Information Screen										
Point Number	Name	Slide Mult.	Slide Div.	Slide Off.	Design Suc.PSI	Design Dis.PSI	Nominal Tonnage(of Step)	EXV Start (When Lead)	Type	
M-1 ...	COMP	---	---	---	---	---	0	38	Step w \ EXV	
M-2 ...	REV VALVE	---	---	---	---	---	---	---	Step w \ EXV	
M-3 ...	SUPPLY FAN	---	---	---	---	---	---	---	Screw w \ EXV	
M-4 ...	SPAREM-4	---	---	---	---	---	---	---	Screw NO EXV	
M-5 ...	INV RUN	---	---	---	---	---	---	---	Pulse Relay	
M-6 ...	INV RESET	---	---	---	---	---	---	---	Alm-Emerg Stop	
M-7 ...	GARAGE LT	---	---	---	---	---	---	---	Alm-Freeze Fault	
									Alm-Hi Sump Temp	

22.4. Circuit Base

In the Circuit Base screen you need to select the Analog Output for the EXV.

Select Output and Sensor Inputs per circuit										
Circuit # (reset button)	Alarm Relay	Comp Proof	Compr Speed(%) or Modulate Hot Gas AO	Compressor Speed Fault	Slide Closed Indicator	Pump Down	Evaporator EXV Output	Flow	Circuit Pump/Valve	
1	Not Used	Not Used	Not Used	Not Used	Not Used	DISABLE 1	EXV1 %	Not Used	Not Used	
2	Not Used	Not Used	Not Used	Not Used	Not Used	DISABLE 2	RO		Not Used	
3	Not Used	Not Used	Not Used	Not Used	Not Used	Not Used	EXV1 %		Not Used	
4	Not Used	Not Used	Not Used	Not Used	Not Used	Not Used	EXV2 %		Not Used	
5	Not Used	Not Used	Not Used	Not Used	Not Used	Not Used	CHW PMP1%		Not Used	
6	Not Used	Not Used	Not Used	Not Used	Not Used	Not Used	CHW PMP2%		Not Used	
7	Not Used	Not Used	Not Used	Not Used	Not Used	Not Used	CND VFD1%		Not Used	
8	Not Used	Not Used	Not Used	Not Used	Not Used	Not Used	CND VFD2%		Not Used	
9	Not Used	Not Used	Not Used	Not Used	Not Used	Not Used	SPARE1-3		Not Used	

Next in the Circuit Base screen you need to select 'Fast SSH' or 'Fast SSH2' from the Evaporator EXV Control section drop down menu.

Circuit # (reset button)	# of Cond ROs	Starting Condenser RO	Condenser Fan AO	Starting Condenser Fault	# Cond Faults	Cond Fan Bank	Condenser Coil Temp #1	Condenser Coil Temp #2	Tandem EXV Circuit #	Evaporator EXV Control
1	1	COND FAN	COND CTRL	Not Used	0	1	CONDIN T	Not Used	1	Fast SSH2
2	0	Not Used	Not Used	Not Used	0	2	Not Used	Not Used	2	Cond Lvl
3	0	Not Used	Not Used	Not Used	0	3	Not Used	Not Used	3	Fast SSH
4	0	Not Used	Not Used	Not Used	0	4	Not Used	Not Used	4	Fast SSH2
5	0	Not Used	Not Used	Not Used	0	5	Not Used	Not Used	5	Evap Appr
6	0	Not Used	Not Used	Not Used	0	1	Not Used	Not Used	1	Fast Evap App
7	0	Not Used	Not Used	Not Used	0	2	Not Used	Not Used	2	Fast EvpLvl
8	0	Not Used	Not Used	Not Used	0	3	Not Used	Not Used	3	Fast DSH

With the release of Fast SSH2 MCS has released a new MCS-Config to support the new functions. The new MCS-Config provides a new tab, 'EXV Control', where you define your system. This then allows MCS-Config to provide MCS Default Set Point Values for you. The figure below shows the Current 'Circuit Base' tab and the new 'EXV Control' tab.



If you enter data in the EXV portion of the Circuit Base tab or in the EXV Control tab it is carried through to the other tab.

22.4.1 Selecting the 'EXV Control' tab you are prompted with the following:

The screenshot shows the 'EXV Control Wizard' interface. It includes several configuration sections: 'Control Parameter' with radio buttons for Suction Superheat, Discharge Superheat, Evaporator Level, Condenser Level, and Approach; 'Heat Exchanger Type' with radio buttons for DX Coil, Plate HX, DX Barrel, and Flooded Barrel; 'Control Method' with radio buttons for Normal (Original), Fast I, and Fast II; and 'Target Modifier' with checkboxes for Low Discharge Superheat, Oversized Condenser/High Ambient, Maximum Operating Pressure (MOP), Minimum Differential Pressure (MDP), Target Reset, Low Suction, Low/High Level, and Level->CAP. A 'Set Values to Default' button is located on the right.

Below the configuration sections are two tables of setpoints:

EXV Control Setpoints																	
#	Name	Value	Min	Max	Adjust Value	Time (SEC)	Max Time Allowed (SEC)	Lockout Delay (HRS)	Safety Down Time(MIN)	Active or Non-Active	Select Value: # decimals & unit char	Level (l) Auth. To Display	Type of Setpoint	Comments	SEC. to Ignore Safety	Window to Est. Safety Time(SEC)	Safety Time Extension (SEC)
9	SHTRG/SHAvg	12	0	18	0.1	1	1	0	0	Active	TEMP	View Only	Time				
10	FAST_ZONE	2	1.6	3	0.1	0	0	0	0	Active	TEMP	View Only	Time				
11	LQAd/REHEAT	0.2	0	1	0.1	0	10	0	0	Active	HUMD or %	View Only	Time				
12	SHMpp/ESPRED	2	1	3	1	1	5	0	0	Active	DIGITAL/5v	View Only	Time				
13	ReMpp/LSMpp	2	1	3	1	3	5	0	0	Active	DIGITAL/5v	View Only	Time				
14	LmZn/LmZn	0.5	0.3	0.5	0.1	0	0	0	0	Active	DECINCH	View Only	Time				
15	VMIN/SHMpp	3	2	50	1	3	5	0	0	Active	HUMD or %	View Only	Time				
16	VMAX/NTUSED	100	60	100	1	0	0	0	0	Active	HUMD or %	View Only	Setpoint				
17	LSnT/TmH	4	2	5	0.1	60	120	2	5	Active	TEMP	View Only	Alarm		0	300	120
18	LS Tm/AdjTm	5	2	10	1	5	15	0	0	Active	SECONDS	View Only	Time				
19	EXVdy/Spnd	1	1	30	1	0	12	0	0	Active	SECONDS	View Only	Time				
20	EXV Tm/Cmpdy	125	30	144	1	0	12	0	0	Active	SECONDS	View Only	Time				

Fast Subcooler Setpoints																	
#	Name	Value	Min	Max	Adjust Value	Time (SEC)	Max Time Allowed (SEC)	Lockout Delay (HRS)	Safety Down Time(MIN)	Active or Non-Active	Select Value: # decimals & unit char	Level (l) Auth. To Display	Type of Setpoint	Comments	SEC. to Ignore Safety	Window to Est. Safety Time(SEC)	Safety Time Extension (SEC)
65	SC FAST TARG	18	12	22	0.5	1	5	0	0	Active	TEMP	View Only	Time				
66	SC FAST ZONE	2	1	3	0.5	2	5	0	0	Active	TEMP	View Only	Time				
67	SC SH/RC ADJ	0.3	0.1	1	0.1	1	50	0	0	Active	DECINCH	View Only	Time				
68	SC FAST LIMT	0.4	0.1	2	0.1	10	20	0	0	Active	DECINCH	View Only	Time				
69	SC MIN/MAX V	2	1	20	1	100	100	0	0	Active	HUMD or %	View Only	Time				
70	SC LOW SH	5	2	10	1	15	60	0	0	Active	TEMP	View Only	Setpoint				
71	SC EXV DELAY	1	1	10	1	0	0	0	0	Active	SECONDS	View Only	Setpoint				
72	SC START TME	5	1	120	1	0	0	0	0	Active	SECONDS	View Only	Setpoint				

Based on your selections will dictate the set points for compressor control. The subcooler set points are only displayed if a subcooler id present.

22.4.2 Selection Options

The diagram shows the 'EXV Control Wizard' interface with several callout boxes:

- Superheat Control based on ?**: Points to the 'Control Parameter' section.
- Superheat Control method type ?**: Points to the 'Control Method' section.
- Config Creation or reset to MCS Defaults**: Points to the 'Set Values to Default' button.
- Evaporator Type being controlled ?**: Points to the 'Heat Exchanger Type' section.
- Functions Effecting Superheat control. Some require set points to be active**: Points to the 'Target Modifier' section.



NOTE: Once you have clicked on the boxes for your setup, be sure to click on 'Set Values to Default'. This will set the values to the default for 'Control Parameter, Heat Exchanger Type and the Control Method. Make note that clicking in the 'Target Modifier' require that some set points must be active.

22.4.3 Compressor EXV Results

EXV Control Setpoints																	
#	Name	Value	Min	Max	Adjust Value	Time (SEC)	Max Time Allowed (SEC)	Lockout Delay (HRS)	Safety Down Time(MIN)	Active or Non-Active	Select Value: # decimals & print char	Level Of Auth. To Display	Type of Setpoint	Comments	SEC to Ignore Safety	Window to Ext. Safety Time(SEC)	Safety Time Extension (SEC)
9	FAST SH TRGT	12	8	20	0.1	3	7	0	0	Active	... TEMP	View Only	Time	...	---	---	---
10	FAST CTL ZN	1.6	1	3	0.1	0	0	0	0	Active	... TEMP	View Only	Time	...	---	---	---
11	EXV LD/UNLD%	0.3	0	0.5	0.1	0	0	0	0	Active	... HUMD or %	View Only	Time	...	---	---	---
12	SH MPY/%SPRD	2	1	3	1	0	0	0	0	Active	... DIGITAL/SW	View Only	Time	...	---	---	---
13	ROC MPY/LSUC	2	1	3	1	3	5	0	0	Active	... DIGITAL/SW	View Only	Time	...	---	---	---
14	LIMIT ADJUST	1	0.1	1.5	0.1	0	0	0	0	Active	... DEC INOCH	View Only	Time	...	---	---	---
15	V MIN LS MPY	3	2	25	1	2	5	0	0	Active	... HUMD or %	View Only	Time	...	---	---	---
16	V MAX	100	50	100	1	0	1	0	0	Active	... HUMD or %	View Only	Setpoint	...	---	---	---
17	LO SUPERHEAT	3.5	2	5	0.1	60	120	2	10	Active	... TEMP	View Only	Alarm	...	0	300	120
18	LOW PSI DELY	5	1	30	1	30	60	0	0	Active	... SECONDS	View Only	Time	...	---	---	---
19	EXV DELAY	1	1	30	1	0	0	0	0	Active	... SECONDS	View Only	Time	...	---	---	---
20	EXV STRT TME	126	1	270	9	10	10	0	0	Active	... SECONDS	View Only	Time	...	---	---	---

- Control on 'Suction Superheat'
- Evaporator Type 'Plate HX'
- Control Method 'Fast SSH2'
- MCS Default 'Selected'
- Degrees F or C are automatic

22.4.4 Subcooler EXV Results

- If you have selected Fast SSH or Fast SSH2 and have a subcooler this will use set points 65 through 72. If you setup 'Subcooler EXV & Subcooler Suction PSI' MCS-Config will automatically complete set points 65 through 72 with MCS standard defaults.
- If this is an existing config and you are converting to Fast SSH or Fast SSH2 set points 253 through 255 will be spared out. (HVAC only)

Fast Subcooler Setpoints																	
#	Name	Value	Min	Max	Adjust Value	Time (SEC)	Max Time Allowed (SEC)	Lockout Delay (HRS)	Safety Down Time(MIN)	Active or Non-Active	Select Value: # decimals & print char	Level Of Auth. To Display	Type of Setpoint	Comments	SEC to Ignore Safety	Window to Ext. Safety Time(SEC)	Safety Time Extension (SEC)
65	SC FAST TARG	18	12	22	0.5	1	5	0	0	Active	... TEMP	View Only	Time	...	---	---	---
66	SC FAST ZONE	2	1	3	0.5	2	5	0	0	Active	... TEMP	View Only	Time	...	---	---	---
67	SC SH/RC ADJ	0.3	0.1	1	0.1	1	50	0	0	Active	... DEC INOCH	View Only	Time	...	---	---	---
68	SC FAST LMT	0.4	0.1	2	0.1	10	20	0	0	Active	... DEC INOCH	View Only	Time	...	---	---	---
69	SC MIN/MAX V	2	1	20	1	100	100	0	0	Active	... HUMD or %	View Only	Time	...	---	---	---
70	SC LOW SH	5	2	10	1	15	60	0	0	Active	... TEMP	View Only	Setpoint	...	---	---	---
71	SC EXV DELAY	1	1	10	1	0	0	0	0	Active	... SECONDS	View Only	Setpoint	...	---	---	---
72	SC START TME	5	1	120	1	0	0	0	0	Active	... SECONDS	View Only	Setpoint	...	---	---	---

- Set Points if Fast SSH or Fast SSH2 selected & you have a Sub Cooler
- Set Points 65 thru 72 are set up
- Degrees F or C are automatic

With this release of MCS-Config MCS has developed Default Set Points for all EXV Types

22.4.5 MCS EXV Factory Default Set Point

22.4.5.1. Fast SSH2, Suction Superheat, Plate HX

EXV Control Setpoints																		
#	Name	Value	Min	Max	Adjust Value	Time (SEC)	Max Time Allowed (SEC)	Lockout Delay (HRS)	Safety Down Time(MIN)	Active or Non-Active	Select Value: # decimals & print char	Level Of Auth. To Display	Type of Setpoint	Comments	SEC to Ignore Safety	Window to Ext. Safety Time(SEC)	Safety Time Extension (SEC)	
9	TARG/S STOP	12	8	20	0.1	2	7	0	0	Active	... TEMP	Factory L1	Time		...	-----	-----	
10	FAST CTL ZN	2	1.6	3	0.1	0	0	0	0	Active	... TEMP	Factory L1	Time		...	-----	-----	
11	EXV LD/UNLD%	0	0	0.5	0.1	0	10	0	0	Active	... HUMD or %	Factory L1	Time		...	-----	-----	
12	SH MPL/%SPRD	1	1	3	1	5	10	0	0	Active	... DIGITAL/Sw	Factory L1	Time		...	-----	-----	
13	ROC MPY/LSUC	1	1	3	1	4	15	0	0	Active	... DIGITAL/Sw	Factory L1	Time		...	-----	-----	
14	LIMIT ADJUST	0.5	0.1	1.5	0.1	0	0	0	0	Active	... DECINCH	Factory L1	Time		...	-----	-----	
15	VMIN/LSH MPY	3	2	25	1	2	15	0	0	Active	... HUMD or %	Factory L1	Time		...	-----	-----	
16	VMAX	100	50	100	1	0	0	0	0	Active	... HUMD or %	Factory L1	Setpoint		...	-----	-----	
17	LO SUPERHEAT	3	2	5	0.1	60	300	2	10	Active	... TEMP	Factory L1	Alarm	...	0	300	120	
18	LSUC/LSH DLY	1	1	10	1	1	10	0	0	Active	... SECONDS	Factory L1	Time		...	-----	-----	
19	E DLY/S CALC	1	1	30	1	0	10	0	0	Active	... SECONDS	Factory L1	Time		...	-----	-----	
20	E STRT/C DLY	126	1	270	1	8	15	0	0	Active	... SECONDS	Factory L1	Time		...	-----	-----	

22.4.5.2. Fast SSH2, Suction Superheat, DX Coil

EXV Control Setpoints																		
#	Name	Value	Min	Max	Adjust Value	Time (SEC)	Max Time Allowed (SEC)	Lockout Delay (HRS)	Safety Down Time(MIN)	Active or Non-Active	Select Value: # decimals & print char	Level Of Auth. To Display	Type of Setpoint	Comments	SEC to Ignore Safety	Window to Ext. Safety Time(SEC)	Safety Time Extension (SEC)	
9	TARG/S STOP	10	8	18	0.1	4	7	0	0	Active	... TEMP	Factory L1	Time		...	-----	-----	
10	FAST CTL ZN	2	1.6	3	0.1	0	0	0	0	Active	... TEMP	Factory L1	Time		...	-----	-----	
11	EXV LD/UNLD%	0.2	0	3	0.1	0	0	0	0	Active	... HUMD or %	Factory L1	Time		...	-----	-----	
12	SH MPL/%SPRD	1	1	3	1	0	5	0	0	Active	... DIGITAL/Sw	Factory L1	Time		...	-----	-----	
13	ROC MPY/LSUC	2	1	3	1	3	5	0	0	Active	... DIGITAL/Sw	Factory L1	Time		...	-----	-----	
14	LIMIT ADJUST	0.5	0.3	0.5	0.1	0	0	0	0	Active	... DECINCH	Factory L1	Time		...	-----	-----	
15	VMIN/LSH MPY	3	2	50	1	3	5	0	0	Active	... HUMD or %	Factory L1	Time		...	-----	-----	
16	VMAX	100	60	100	1	0	0	0	0	Active	... HUMD or %	Factory L1	Setpoint		...	-----	-----	
17	LO SUPERHEAT	4	2	4	0.1	60	120	2	5	Active	... TEMP	Factory L1	Alarm	...	0	300	120	
18	LSUC/LSH DLY	5	2	15	1	5	15	0	0	Active	... SECONDS	Factory L1	Time		...	-----	-----	
19	E DLY/S CALC	20	1	60	1	8	12	0	0	Active	... SECONDS	Factory L1	Time		...	-----	-----	
20	E STRT/C DLY	126	30	180	1	8	12	0	0	Active	... SECONDS	Factory L1	Time		...	-----	-----	

22.4.5.3. Fast SSH, Suction Superheat, DX Barrel

EXV Control Setpoints																		
#	Name	Value	Min	Max	Adjust Value	Time (SEC)	Max Time Allowed (SEC)	Lockout Delay (HRS)	Safety Down Time(MIN)	Active or Non-Active	Select Value: # decimals & print char	Level Of Auth. To Display	Type of Setpoint	Comments	SEC to Ignore Safety	Window to Ext. Safety Time(SEC)	Safety Time Extension (SEC)	
9	TARG/S STOP	12	8	20	0.1	2	5	0	0	Active	... TEMP	Factory L1	Time		...	-----	-----	
10	FAST CTL ZN	2	1.6	3	0.1	1	1	0	0	Active	... TEMP	Factory L1	Time		...	-----	-----	
11	EXV LD/UNLD%	0	0	0.5	0.1	0	10	0	0	Active	... HUMD or %	Factory L1	Time		...	-----	-----	
12	SH MPL/%SPRD	1	1	3	1	5	10	0	0	Active	... DIGITAL/Sw	Factory L1	Time		...	-----	-----	
13	ROC MPY/LSUC	1	1	3	1	4	15	0	0	Active	... DIGITAL/Sw	Factory L1	Time		...	-----	-----	
14	LIMIT ADJUST	0.2	0.1	0.4	0.1	3	6	0	0	Active	... DECINCH	Factory L1	Time		...	-----	-----	
15	VMIN/LSH MPY	3	2	25	1	2	15	0	0	Active	... HUMD or %	Factory L1	Time		...	-----	-----	
16	VMAX	100	50	100	1	0	0	0	0	Active	... HUMD or %	Factory L1	Setpoint		...	-----	-----	
17	LO SUPERHEAT	3	1	5	0.1	120	300	2	10	Active	... TEMP	Factory L1	Alarm	...	0	300	120	
18	LSUC/LSH DLY	1	1	10	1	1	10	0	0	Active	... SECONDS	Factory L1	Time		...	-----	-----	
19	E DLY/S CALC	1	1	30	1	10	10	0	0	Active	... SECONDS	Factory L1	Time		...	-----	-----	
20	E STRT/C DLY	126	1	270	1	8	15	0	0	Active	... SECONDS	Factory L1	Time		...	-----	-----	

(Samples of Fast SSH & Fast SSH2 most often used)

22.4.5.4. Fast SSH2, Discharge Superheat, DX Barrel

EXV Control Setpoints																		
#	Name	Value	Min	Max	Adjust Value	Time (SEC)	Max Time Allowed (SEC)	Lockout Delay (HRS)	Safety Down Time(MIN)	Active or Non-Active	Select Value: # decimals & print char	Level Of Auth. To Display	Type of Setpoint	Comments	SEC to Ignore Safety	Window to Ext. Safety Time(SEC)	Safety Time Extension (SEC)	
9	DShTRG/ShAvg	30	22	40	0.1	1	1	0	0	Active	... TEMP	Factory L1	Time		...	-----	-----	
10	FAST ZONE	2	1.6	3	0.1	0	0	0	0	Active	... TEMP	Factory L1	Time		...	-----	-----	
11	LdAdj/REHEAT	0.2	0	3	0.1	0	10	0	0	Active	... HUMD or %	Factory L1	Time		...	-----	-----	
12	ShMpy/%SPRED	2	1	3	1	0	5	0	0	Active	... DIGITAL/Sw	Factory L1	Time		...	-----	-----	
13	RcMpy/LSuMpy	2	1	3	1	3	5	0	0	Active	... DIGITAL/Sw	Factory L1	Time		...	-----	-----	
14	LmZn/LmbZn	0.5	0.3	0.5	0.1	0	0	0	0	Active	... DECINCH	Factory L1	Time		...	-----	-----	
15	VMIN/LSH Mpy	3	2	50	1	3	5	0	0	Active	... HUMD or %	Factory L1	Time		...	-----	-----	
16	VMAX/NOTUSED	100	60	100	1	0	0	0	0	Active	... HUMD or %	Factory L1	Setpoint		...	-----	-----	
17	LShF/TmFlr	4	2	4	0.1	60	120	2	5	Active	... TEMP	Factory L1	Alarm	...	0	300	120	
18	LsTm/AdjTm	5	2	15	1	5	15	0	0	Active	... SECONDS	Factory L1	Time		...	-----	-----	
19	EXVDly/Spred	1	1	60	1	8	12	0	0	Active	... SECONDS	Factory L1	Time		...	-----	-----	
20	EXVStm/CmpDy	126	30	135	1	8	12	0	0	Active	... SECONDS	Factory L1	Time		...	-----	-----	

22.4.5.5. Fast SSH, Suction Superheat, DX Barrel

EXV Control Setpoints																	
#	Name	Value	Min	Max	Adjust Value	Time (SEC)	Max Time Allowed (SEC)	Lockout Delay (HRS)	Safety Down Time(MIN)	Active or Non-Active	Select Value: # decimals & print char	Level Of Auth. To Display	Type of Setpoint	Comments	SEC to Ignore Safety	Window to Ext. Safety Time(SEC)	Safety Time Extension (SEC)
9	TARG/S STOP	12	8	20	0.1	2	5	0	0	Active	... TEMP	Factory Lr	Time
10	FAST CTL ZN	2	1.6	3	0.1	1	1	0	0	Active	... TEMP	Factory Lr	Time
11	EXV LD/UNLD%	0	0	0.5	0.1	0	10	0	0	Active	... HUMD or %	Factory Lr	Time
12	SH MPL/ZSPRD	1	1	3	1	5	10	0	0	Active	... DIGITAL/Sv	Factory Lr	Time
13	ROC MPY/LSUC	1	1	3	1	4	15	0	0	Active	... DIGITAL/Sv	Factory Lr	Time
14	LIMIT ADJUST	0.2	0.1	0.4	0.1	3	6	0	0	Active	... DECINCH	Factory Lr	Time
15	VMIN/LSH MPY	3	2	25	1	2	15	0	0	Active	... HUMD or %	Factory Lr	Time
16	VMAX	100	50	100	1	0	0	0	0	Active	... HUMD or %	Factory Lr	Setpoint
17	LO SUPERHEAT	3	1	5	0.1	120	300	2	10	Active	... TEMP	Factory Lr	Alarm	...	0	300	120
18	LSUC/LSH DLY	1	1	10	1	1	10	0	0	Active	... SECONDS	Factory Lr	Time
19	E DLYS CALC	1	1	30	1	10	10	0	0	Active	... SECONDS	Factory Lr	Time
20	E STRT/C DLY	126	1	270	1	8	15	0	0	Active	... SECONDS	Factory Lr	Time

22.4.5.6. Suct Spht, Suction Superheat, DX Barrel

EXV Control Setpoints																	
#	Name	Value	Min	Max	Adjust Value	Time (SEC)	Max Time Allowed (SEC)	Lockout Delay (HRS)	Safety Down Time(MIN)	Active or Non-Active	Select Value: # decimals & print char	Level Of Auth. To Display	Type of Setpoint	Comments	SEC to Ignore Safety	Window to Ext. Safety Time(SEC)	Safety Time Extension (SEC)
9	TARG/S STOP	12	8	20	0.1	2	5	0	0	Active	... TEMP	Factory Lr	Time
10	FAST CTL ZN	2	1.6	3	0.1	1	1	0	0	Active	... TEMP	Factory Lr	Time
11	EXV LD/UNLD%	0	0	0.5	0.1	0	10	0	0	Active	... HUMD or %	Factory Lr	Time
12	SH MPL/ZSPRD	1	1	3	1	5	10	0	0	Active	... DIGITAL/Sv	Factory Lr	Time
13	ROC MPY/LSUC	1	1	3	1	4	15	0	0	Active	... DIGITAL/Sv	Factory Lr	Time
14	LIMIT ADJUST	0.2	0.1	0.4	0.1	3	6	0	0	Active	... DECINCH	Factory Lr	Time
15	VMIN/LSH MPY	3	2	25	1	2	15	0	0	Active	... HUMD or %	Factory Lr	Time
16	VMAX	100	50	100	1	0	0	0	0	Active	... HUMD or %	Factory Lr	Setpoint
17	LO SUPERHEAT	3	1	5	0.1	120	300	2	10	Active	... TEMP	Factory Lr	Alarm	...	0	300	120
18	LSUC/LSH DLY	1	1	10	1	1	10	0	0	Active	... SECONDS	Factory Lr	Time
19	E DLYS CALC	1	1	30	1	10	10	0	0	Active	... SECONDS	Factory Lr	Time
20	E STRT/C DLY	126	1	270	1	8	15	0	0	Active	... SECONDS	Factory Lr	Time

22.5. Set Point Descriptions (Fast SSH & Fast SSH2)

Fast SSH set points **Available in MCS release 17.26-B and later**

Fast SSH2 set points **Available in MCS release 17.41 and later**

SP #	Name	Description
9	EXV Target	(Value Field) – This is the superheat target the system will make adjustments to the Electronic Expansion Valve to maintain. (Time Field) – In Fast SSH when in low suction psi this is the number of seconds the suction psi must be increasing before the systems stops adjusting the valve. (Time Field) - In Fast SSH2 it is the number of seconds to calculate the extended slope. When in low suction, adjustments are stopped when the suction pressure slope is positive for 1 second.
10	EXV Fast Zone	((Value Field) – The system makes adjustments to the EXV Valve percentage to maintain the superheat within this range. (Time Field) – The Time Field is not used.
11	EXV Adjustment made when a modulating compressor's capacity changes	(Value Field) – The opening adjustment that is made to the EXV current valve % when the circuit changes to the loading state or the closing adjustment that is made when the circuit changes to the unloading state. When in the MOP hold state, only closing adjustments are allowed. (Time Field) – When > zero it is used to increase the hold time.
12	Super Heat adjust multiplier	(Value Field) – This value is used to multiply times the calculated value of superheat target – current superheat target value. (The difference from where we want to be verses where we are) (Time Field) – The maximum different between two EXV's on the same circuit allowed once out of startup and under control.

13	Rate of Change adjust multiplier	<p>(Value Field) - This value is used to multiply times the calculated value of current superheat – the superheat value one second ago. (The slope of the current superheat)</p> <p>Time Field) – If set point type = ‘Time’ and Time Field is ≥ 2 and ≤ 100 this is the adjustment multiplier for when the system is in Low Suction. It takes the base valve adjustment of 0.5% and multiplies it with this value. Adjustments stop when the suction psi starts too increase. (See set point 9 time field for additional information.) If the conditions are not met then a value of 0.5 is used. (Delay between adjustments is specified in the value field of SP 17.)</p>
14	Limit of Adjustment	<p>(Value Field) – In FSH this value limits the adjustment while the superheat is $<$ then the Fast Zone times two. In FSH2 this value is the maximum limit of the adjustment.</p> <p>(Time Field) - In FSH this value is the limit of adjustment when the superheat $>$ then two times the Fast Zone. Remember in the value field of this set point you are typically using a value of 0.2 to 0.5. In the time field a value of 7 is equivalent to 0.7.</p> <p>(Time Field) - In FSH2 this field is not used.</p>
15	Minimum EXV Valve %	<p>(Value Field) – The minimum position of the valve. Usually 3%. Will need to be larger if hot gas is on system.</p> <p>(Time Field) - The adjustment multiplier for when the system is in Low Superheat.</p>
16	Maximum EXV Valve %	<p>(Value Field) – The maximum position of the valve allowed. Usually 100%. Sometimes used if valve is oversized.</p> <p>(Time Field) – Not Used</p>
17	Low Superheat	<p>(Value Field) – If the superheat falls below this value and stays below for longer than the number of seconds specified in the Time Field, of this set point, the system will enter a safety, generate an alarm and shut off this compressor then restart if required. If this specifies a lockout then it will follow the lockout rules. In FSH and FSH2 the system will take corrective action to correct this potential problem.</p> <p>(Time Field) – Timer for this set point as described.</p>
18	Low Psi Delay	<p>(Value Field) – The value specifies the number of seconds between valve adjustments, (for Low Suction) trying to correct this situation. Adjustments will continue until the slope of the suction pressure starts to increase.</p> <p>(Time Field) – This value specifies the number of seconds delay between adjustments, (for Low Superheat) trying to correct this situation. Adjustments continue until the superheat is above the Value Field.</p>
19	EXV Delay	<p>(Value field) – The value in this field id decremented by the difference between the absolute value of the current superheat – superheat target. When the result reaches zero the FSH & FSH2 make the current calculated adjustment to the current valve percentage.</p> <p>(Time Field) – The value in the time field determines when control will begin when two EXV’s are on the same circuit. This value times the value field in the fast zone plus the current target defines when control is taken, at startup. If this value is 10 and the value in the fast zone is 2 and the target is 12 the result would be $(10 * 2 + 12) = 32\%$. When both valves are \leq this % control is taken and then kept within the value specified in the time field of set point 12.</p>
20	EXV Startup Time	<p>(Value Field) – EXV starting time in seconds. The following decisions are made on taking control:</p> <ol style="list-style-type: none"> If the current superheat is $>$ target + 5.0 ° & State timer $>$ Startup time / 2 Take control. If the current superheat is $<$ target – Fast zone & State timer $>$ Startup time / 2 Take Control. If the Suct psi is $<$ Low Suct SP + Low unload & State timer $>$ Startup time / 2 Take Control. If the EXV startup time ≥ 90 & a) or b) is true adjust the valve start percentage

22.5.1 Set Point Adjustments

Fast SSH & Fast SSH2 Common adjustments

When using FSH or FSH2 you should not experience a low suction or low superheat alarm unless you are low on refrigerant or have a mechanical problem. (If you bring on too much condenser that causes the head psi to drop too quickly it will also pull the suction psi with it.) Set the multiplier of SP 13 'Time Field' to a value high enough to recover from a low suction.

22.5.2 Low Suction Multiplier-SP 13

'Time Field' is a multiplier for the change being made to adjust for a Low Suction condition. The MCS Default is 2. If a low suction occurs and the system does not recover in time, an a low suction alarm occurs increase SP 13 Time Field by 1.

If a low suction occurs and the system over corrects, (that is the EXV valve opens more than is required) then reduce SP 13 Time Field by 1.

If an alarm occurs you can increase the multiplier and or decrease the time delay between adjustments. (Set Point 18 Value Field)

22.5.2.1. Low Superheat Adjustment-SP 15

'Time Field' is a multiplier for the change being made to adjust for a Low Superheat condition. The MCS Default is 2.

If a low superheat occurs and the system over corrects, (the EXV valve closes more than is required) then reduce SP 15 Time Field by 1.

If an alarm occurs you can increase the multiplier and or decrease the time delay between adjustments. (Set Point 18 Time Field)

22.5.2.2. EXV Startup Time-SP 20

'Value Field' specifies the maximum time the valve will remain in the EXV Startup State. If the value is less than 90 seconds the Magnum will remain in this state for the entire time specified unless it reaches one of the startup exit conditions covered in SP 20. It is not recommended to make this value less than 25 seconds.

If the value is ≥ 90 the Magnum will calculate a new valve opening percentage, if required. When setting a value of 90, or greater it is recommended it be in increments of 9 for Fast SSH. For Fast SSH the Magnum starts evaluating it's position after 44% of its startup time has passed. In Fast SSH2 it starts evaluation after 50% of its startup time has passed.

22.5.2.3. EXV Compressor Start Delay-SP 20

'Time Field' specifies the number of seconds to delay starting the compressor to allow the valve to partially open. MCS recommends 8 to 10 seconds and not more than 15 seconds. Remember this is part of the EXV startup time.

22.5.2.4. EXV Target & EXV Fast Zone-SP 9

'Value Field' specifies the superheat target we want to achieve and SP 10 'Value Field' specifies the Control Zone we are maintaining. The table shows the MCS recommendations for both English and Metric.

Units	English			Metric		
	Low	Standard	High	Low	Standard	High
Superheat	10.0	12.0	14.0	5.6	6.7	7.8
Fast Zone	1.6	2.0	3.0	0.9	1.1	1.7

22.6. Fast SSH States

Listed below shows the format of the states used.

EXV-AA-BB-CCCC

AA	DESC.	BB	DESC	CCCC	DESC.
HD	HOLDING	>T	GREATER TARG	RcSm	RATE OF CHANGE SMALL
OP	OPENING	<T	LESS TARG	RcLg	RATE OF CHANGE LARGE
CL	CLOSING	Sh	SUPERHEAT	ShHi	SUPERHEAT HIGH
				ShSm	SUPERHEAT SMALL
				Rc=0	RATE OF CHANGE EQUALS ZERO
				InDb	IN DEAD BAND
				InZn	IN ZONE

22.6.1 FAST SSH2 State Format

Listed below shows the format of the states used.

EXV-AA-BB-CCCC

AA	DESC.	BB	DESC	CCCC	DESC.
HD	HOLDING	>T	GREATER TARG	EsLo	EXTENDED SLOPE LOW
OP	OPENING	<T	LESS TARG	EsHi	EXTENDED SLOPE HIGH
CL	CLOSING	Es	EXTENDED SLOPE	0 OR 1	EXTENDED SLOPE IS 0 OR 1
		Sh	SUPERHEAT	= T	SUPERHEAT EQUALS TARGET
				ShHi	SUPERHEAT HIGH
				ShLo	SUPERHEAT LOW
				St=5	STATE TIMER EQUALS 5
				RcSm	RATE OF CHANGE SMALL
				RcLg	RATE OF CHANGE LARGE
				Rc=0	RATE OF CHANGE EQUALS ZERO
				InDb	IN DEAD BAND
				InZn	IN ZONE

Chapter - 23. General Introduction to EXV PID

23.1. MCS PID REQUIREMENTS

- FIRMWARE 17.60E4 or greater
- MCS-CONNECT 18.26.11 or greater
- MCS-CONFIG 18.01N or greater

- An EXV PID controller uses information about: PRESENT, PAST and errors to adjust the Expansion Valve.
- EXV PID automatically applies accurate and responsive correction to a control function.

P	PROPORTIONAL (Kp)	Change in Superheat = Current Superheat minus last Superheat from 1 second ago (Rate of Change)
I	INTEGRAL (Ki)	Offset in Superheat = Current Superheat minus Target Superheat (setpoint #9 value field)
D	DERIVATIVE (Kd)	Velocity of Superheat = Current Superheat minus the Superheat from x seconds ago (setpoint #9 time seconds value)
A	ACCELERATION (Ka)	Change in Velocity = Current Kd minus the Kd from x seconds ago (setpoint #9 time seconds value)

23.2. Calculations for the adjustment to EXV valve

MCS EXV PID algorithm uses two different sets of K multipliers to calculate adjustments to EXV on how far the superheat is from the superheat target, (setpoint #9 value field).

#	SetPoints	Value	Time	SEC Ig...	windo...	safety ...	HI zone	LOW z...	Setback
1	COOL TARGET	46.0F	----	----	----	----	----	----	----
2	CTRL ZONE+	0.5F	----	----	----	----	----	----	----
3	CTRL ZONE-	0.5F	----	----	----	----	----	----	----
8	CHAM LIQ INJ	180.0F	----	----	----	----	----	----	----
9	SucSprHtTarg	12.0F	6 S	----	----	----	4.0F	3.5F	0.0F
10	Ki-IntegMult	0.10	0 S	----	----	----	2.20	-2.20	0.10
12	Kp-PropMult	0.30	0 S	----	----	----	0.00	0.00	0.20
13	Kd-DerrMult	0.17	0 S	----	----	----	0.20	-0.20	0.17
14	Ka-AccMult	0.10	0 S	----	----	----	0.00	0.00	0.00
15	ExvMinValve%	5.0%	----	----	----	----	----	----	----
16	ExvMaxValve%	100....	0 S	----	----	----	0.0%	0.0%	15.0%
17	LoSucSuperHt	3.5F	120 S	15	300	60	----	----	----
19	ExvKiDelay	30s	----	----	----	----	----	----	----
20	ExvStartup	10s	5 S	----	----	----	----	----	----

23.3. EXV PID Firmware

Uses information about: PRESENT, PAST and errors to adjust the Expansion Valve.

- Provides extremely fast reaction to changes in superheat caused in part by the following:
 - High ambient chiller running in low ambient conditions.
 - Condenser fans turning on or off creating large changes in discharge and suction pressure .
 - Subcooling going temporarily negative and not having a solid column of liquid for short periods.
 - Large subcooler / economizers coming on and off.

EXV PID Logic supports:

- Suction Superheat, Discharge Superheat, Evaporator Level and Condenser Level Control.

23.4. MCS PID REQUIREMENTS

- FIRMWARE 17.60E4 or greater
- MCS-CONNECT 18.26.11 or greater
- MCS-CONFIG 18.01N or greater

23.5. Selecting PID in MCS-CONFIG

In PID only setpoints 9 through 20 are used to control the EXV valve. If you select PID as your superheat EXV control and you have a subcooler (an economizer injecting refrigerant into the compression chamber) you will get PIP control on the EXV for the subcooler. The PID set points for the subcooler are 65 through 72. Select Type of Control in Relay Output Information Screen. In the RO screen, from the drop down window in 'Type' you select either 'Step w \ EXV' or 'Screw w \ EXV'.

Relay Output Information Screen									
Point Number	Name	Slide Mult.	Slide Div.	Slide Off.	Design Suc.PSI	Design Dis.PSI	Nominal Tonnage(of Step)	EXV Start (When Lead)	Type
4-1	COMP 1	---	---	---	---	---	0	35	Step w \ EXV
4-2	CHAM INJ 1	---	---	---	---	---	---	---	Standard
4-3	ECONO 1	---	---	---	---	---	0	20	Step w \ EXV
4-4	REV VLV 1	---	---	---	---	---	---	---	Standard

23.6. Circuit Base

In the Circuit Base screen you need to select the Analog Output for the EXV.

Select Output and Sensor Inputs per circuit									
Circuit # (reset button)	Alarm Relay	Comp Proof	Compr Speed(%) or Modulate Hot Gas AN	Compressor Speed Fault	Slide Closed Indicator	Pump Down	Evaporator EXV Output	Flow	
1	Not Used	Not Used	COMP1 SPD	Cmp1VrdFl	Not Used	DISABLE 1	Exv#1-PID	COMP1 FLO	N
2	Not Used	Not Used	COMP2 SPD	Cmp2VrdFl	Not Used	DISABLE 2	RO		N
3	Not Used	Not Used	Not Used	Not Used	Not Used	Not Used	SPARE7-5		W
4	Not Used	Not Used	Not Used	Not Used	Not Used	Not Used	SPARE7-6		W
5	Not Used	Not Used	Not Used	Not Used	Not Used	Not Used	SPARE7-7		W
6	Not Used	Not Used	Not Used	Not Used	Not Used	Not Used	SPARE7-8		W
7	Not Used	Not Used	Not Used	Not Used	Not Used	Not Used	SPARE7-9		W
8	Not Used	Not Used	Not Used	Not Used	Not Used	Not Used	SPARE7-10		W
							COMP1 SPD%		
							COMP2 SPD%		
							Exv#1-PID		



Next in the Circuit Base screen you need to select 'PIP SSH' from the Evaporator EXV Control section drop down menu.

NOTE: TANDEM 6 EXV PER CIRCUIT NOT SUPPORTED IN RTU AND CENTRIFUGAL FIRMWARE

Information that relates to Condensers and Evaporators on the circuit										
Starting condenser Fault	# Cond Faults	Cond Fan Bank	Condenser Coil Temp #1	Condenser Coil Temp #2	Tandem EXV Circuit #	EXV #3 Circuit#	EXV #4 Circuit#	EXV #5 Circuit#	EXV #6 Circuit#	Evaporator EXV Control
Used	0	1	Not Used	Not Used	1	1	1	1	1	PID Cond Lvl
Used	0	2	Not Used	Not Used	2	2	2	2	2	PID Cond Lvl

The MAGNUM supports up to 6 tandem EXVs per circuit.
NOT AVAILABLE with RTU and Centrifugal firmware

With the release of Fast SSH2 AND PID MCS has released a new MCS-Config to support the new functions. The new MCS-Config provides a new tab, 'EXV Control', where you define your system. This then allows MCS-Config to provide MCS Default Set Point Values for you. The figure below shows the Current 'Circuit Base' tab and the new 'EXV Control' tab.

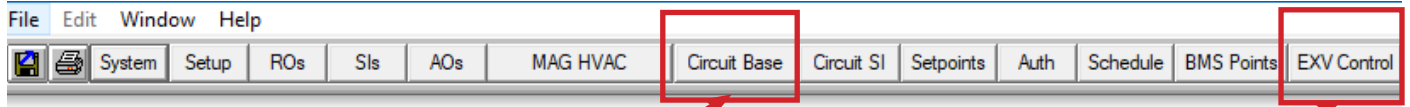

If you enter data in the EXV portion of the Circuit Base tab or in the EXV Control tab it is carried through to the other tab.

23.7. Selecting the 'EXV Control' tab you are prompted with the following:

Selection Option →
(Evaporator and condenser Level not available with Fast I or Fast II Control Method)

EXV Control Wizard

Control Parameter

- Suction Superheat
- Discharge Superheat
- Evaporator Level
- Condenser Level
- Approach

Heat Exchanger Type

- None
- DX Coil
- Water Coil
- DX Barrel
- Flooded Barrel

Control Method

- Nominal (Original)
- Fast I
- Fast II
- PID

Target Modifier

- Low Discharge Superheat
- Oversized Condenser/High Ambient
- Maximum Operating Pressure(MOP)
- Minimum Differential Pressure(MDP)
- Target Reset
- Low Suction
- Low/High Level
- Level-CAP

Set Default Values?
Firmware Version 17.56 or Higher Required

Compressor EXV Results →

EXV Control Setpoints																
#	Name	Value	Min	Max	Adjust Value	Time (SEC)	Max Time Allowed (SEC)	Lockout Delay (HRS)	Safety Down Time(MIN)	Active or Non-Active	Select Value: # decimals & print char	Level Of Auth. To Display	Type of Setpoint	Comments	SEC to Ignore Safety	Win Ext. Time
9	SucSprHTarg	12	8	20	0.1	6	9	0	0	Active	... TEMP	Service L	Target			
10	Ki-IntegMult	0.15	0	3	0.01	0	0	0	0	Active	... DEC2NOCH	Service L	Target			
11	EXV LD/INLD%	0	0	0.5	0.1	0	0	0	0	Non-Active	... HUMD or %	Service L	Time			
12	Kp-PropMult	0.3	0	3	0.01	0	0	0	0	Active	... DEC2NOCH	Service L	Target			
13	Kd-DerivMult	0.2	0	3	0.01	0	0	0	0	Active	... DEC2NOCH	Service L	Target			
14	Ka-AccelMult	0.1	0	3	0.01	0	0	0	0	Active	... DEC2NOCH	Service L	Target			
15	ExvMinValve%	5	2	25	1	2	10	0	0	Active	... HUMD or %	Service L	Target			
16	ExvMaxValve%	100	50	100	1	0	0	0	0	Active	... HUMD or %	Service L	Target			
17	LD SUPERHEAT	3.5	2	4	0.1	120	180	2	10	Active	... TEMP	Service L	Lockout		15	300
18	LOW PSI DELY	1	1	30	1	3	60	0	0	Non-Active	... SECONDS	Service L	Time			
19	ExvKiDelay	15	1	120	1	0	0	0	0	Active	... SECONDS	Service L	Setpoint			
20	ExvStartup	10	5	45	1	5	10	0	0	Active	... SECONDS	Service L	Time			

Subcooler EXV Results →

EXV Control Setpoints																
#	Name	Value	Min	Max	Adjust Value	Time (SEC)	Max Time Allowed (SEC)	Lockout Delay (HRS)	Safety Down Time(MIN)	Active or Non-Active	Select Value: # decimals & print char	Level Of Auth. To Display	Type of Setpoint	Comments	SEC to Ignore Safety	Win Ext. Time
65	SCExvTarget	19	12	22	0.5	6	12	0	0	Active	... TEMP	Service L	Target			
66	SCExvIntegr	0.25	0	3	0.01	0	0	0	0	Active	... DEC2NOCH	Service L	Target			
67	SCExvKProp	0.35	0	3	0.01	0	0	0	0	Active	... DEC2NOCH	Service L	Target			
68	SCExvKDeriv	0.25	0	3	0.01	0	0	0	0	Active	... DEC2NOCH	Service L	Target			
69	SCExvKAccel	0.1	0	3	0.01	0	0	0	0	Active	... DEC2NOCH	Service L	Target			
70	SCLowSprht	5	3	8	0.5	120	300	2	10	Active	... TEMP	Service L	Alarm		0	0
71	SCExvKiDelay	10	1	90	1	0	0	0	0	Active	... SECONDS	Service L	Setpoint			
72	SCExvStartup	10	1	120	1	0	0	0	0	Active	... SECONDS	Service L	Setpoint			

Based on your selections will dictate the set points for compressor control. The subcooler set points are only displayed if a subcooler id is present.

23.8. Selection Options



NOTE: Once you have clicked on the boxes for your setup, be sure to click on **'Set Values to Default'**. This will set the values to the default for **'Control Parameter, Heat Exchanger Type and the Control Method'**. Make note that clicking in the **'Target Modifier'** require that some set points must be active.

23.9. Compressor EXV Results

EXV Control Setpoints																		
#	Name	Value	Min	Max	Adjust Value	Time (SEC)	Max Time Allowed (SEC)	Lockout Delay (HRS)	Safety Down Time(MIN)	Active or Non-Active	Select Value: # decimals & print char	Level Of Auth. To Display	Type of Setpoint	Comments	SEC to Ignore Safety	Window to Ext. Safety Time(SEC)	Safety Time Extension (SEC)	
9	SucSprHtTarg	12	8	20	0.1	6	9	0	0	Active	... TEMP	Service L	Target		...	-----	-----	
10	Ki-IntegMult	0.15	0	3	0.01	0	0	0	0	Active	... DEC2NOCH	Service L	Target		...	-----	-----	
11	EXV LD/UNLD%	0	0	0.5	0.1	0	0	0	0	Non-Active	... HUMD or %	Service L	Time		...	-----	-----	
12	Kp-PropMult	0.3	0	3	0.01	0	0	0	0	Active	... DEC2NOCH	Service L	Target		...	-----	-----	
13	Kd-DerivMult	0.2	0	3	0.01	0	0	0	0	Active	... DEC2NOCH	Service L	Target		...	-----	-----	
14	Ka-AccelMult	0.1	0	3	0.01	0	0	0	0	Active	... DEC2NOCH	Service L	Target		...	-----	-----	
15	ExvMinValve%	5	2	25	1	2	10	0	0	Active	... HUMD or %	Service L	Setpoint		...	-----	-----	
16	ExvMaxValve%	100	50	100	1	0	0	0	0	Active	... HUMD or %	Service L	Target		...	-----	-----	
17	LD SUPERHEAT	3.5	2	4	0.1	120	180	2	10	Active	... TEMP	Service L	Lockout		...	15	300	60
18	LDW PSI DELY	1	1	30	1	3	60	0	0	Non-Active	... SECONDS	Service L	Time		...	-----	-----	
19	ExvKiDelay	15	1	120	1	0	0	0	0	Active	... SECONDS	Service L	Setpoint		...	-----	-----	
20	ExvStartup	10	5	45	1	5	10	0	0	Active	... SECONDS	Service L	Time		...	-----	-----	

- Control on 'Suction Superheat'
- Evaporator Type 'Plate HX'
- Control Method 'PID'
- MCS Default 'Selected'
- Degrees F or C are automatic

23.10. Set Point Descriptions (PID)

Set points Available in MCS release 17.26-B and later

SP #	Name	Description
9	SPRHT TARGET or LEVEL TARGET	If EXV control is based upon superheat, this is the Superheat target that the Magnum will control from. If EXV control is based upon refrigerant level, this is the refrigerant level target that the Magnum will control from. 'Low Zone' if nonzero then develop control super heat based upon the lowest superheat of any compressor that is on with in this suction group else use the superheat of this compressor. 'Time (sec)' field: Seconds between samples used for calculating the Superheat Rate of Change.
	STAGE 7 CUT IN (Cut In/Out Control)	Stage 7 cut in, Setpoint value contains the voltage when this stage is turned on.
10	SPRHT ZONE +- Ki-IntegMult	The value in this setpoint is added and subtracted to setpoint #9 to determine the upper and lower limits of the control zone respectively. Refer to section on EXV control. 'Time (sec)' field: If non-zero, skip ROC adjustment logic in the control zone. EXV PID Integral - Offset in Superheat= Current Superheat minus Target Superheat (setpoint #9 value field) Value is the Fast Multiplier for Kp adjustments, setback is the slow multiplier.
	STAGE 8 CUT IN (Cut In/Out Control)	Stage 8 cut in, Setpoint value contains the voltage when this stage is turned on.
12	EXV FINE ADJ Kp-PropMult	The adjustment is made when in the 1st zone above or below the control zone. Refer to section on EXV control. EXV PID Proportional - Change in Superheat = Current Superheat minus last Superheat from 1 second ago (Rate of Change). Value is the Fast Multiplier for Kp adjustments, setback is the slow multiplier.
13	EXV COURSE Kd-DerrMult	If a course adjustment to the EXV when in the 2nd zone above or below the control zone. If the type is TIME and the time (SEC) field is greater than 1 and less than 7 then multiple the value field by the time field else multiple by 2 for adjustment amount. If a course adjustment to the EXV when in the 3rd zone above or below the control zone. Multiple value by the by 2 for adjustment amount. If a course adjustment to the EXV when above or below the 3rd zone the control zone. The value is the adjustment amount. Refer to section on EXV control. If a course adjustment to the EXV when in the 3rd zone above or below the control zone. Multiple value by the by 2 for adjustment amount. If a course adjustment to the EXV when above or below the 3rd zone the control zone. The value is the adjustment amount. Refer to section on EXV control. EXV PID Derivative - Velocity of Superheat = Current Superheat minus the Superheat from x seconds ago (setpoint #9 time seconds value). Value is the Fast Multiplier for Kp adjustments, setback is the slow multiplier.
14	EXV LOAD DIV Ka-AccMult	The EXV slide adjustment can be fined tuned by dividing by the value of this set point. Note the value of this set point is used regardless if the its is active or not. Refer to section on EXV control. EXV PID Acceleration - Change in Velocity = Current Kd minus the Kd from x seconds ago (setpoint #9 time seconds value). Value is the Fast Multiplier for Kp adjustments, setback is the slow multiplier.
	STAGE 12 CUT IN (Cut In/Out Control)	Stage 12 cut in, Setpoint value contains the voltage when this stage is turned on.

15	ExvMinValve%	This is the minimum valve position allowed when modulating the expansion valve. This value should be set so when hot gas is applied the valve opening is adequate. Note the value of this set point is used regardless if it is active or not. Refer to section on EXV control. Note the value of this set point is used regardless if it is active or not. Refer to section on EXV control. Note the value of this set point is used regardless if it is active or not. Refer to section on EXV control.
	STAGE 13 CUT IN (Cut In/Out Control)	Stage 13 cut in, Setpoint value contains the voltage when this stage is turned on.
16	ExvMaxValve%	This is the maximum position allowed when modulating the expansion valve to maintain the superheat target. This value should be the valve % opening at full capacity plus a 10 to 15 % margin. Note the value of this set point is used regardless if the its is active or not. Refer to section on EXV control.
	STAGE 14 CUT IN (Cut In/Out Control)	Stage 14 cut in, Setpoint value contains the voltage when this stage is turned on.
17	LoSucSuperHt	If super heat is less or equal to this value and the control slope is less that the roc for zone 3 make a slide adjustment of 3 times the value of set point #13. If the calculated superheat remains below this value for the time specified in the Time (SEC) cell, the Magnum will generate a LOW SUPERHEAT alarm. Refer to section on EXV control.
	STAGE 15 CUT IN (Cut In/Out Control)	Stage 15 cut in, Setpoint value contains the voltage when this stage is turned on.
19	EXV DELAY	Delay in seconds between valve adjustments. Should not be less than 48. (When adjusting at 4x this will allow 12 seconds for the controller to process the results of the last action before making the next adjustment). Refer to section on EXV control.
	ExvKiDelay	
20	ExvStartup	This is the time in seconds to hold the valve at the start % setpoint when the compressor starts. Since the superheat calculation is not valid when the compressor is not running the EXV logic sets the valve to a given position for a set time to allow the system to develop a valid superheat. 'Time (sec)' field: If zero, then there is no delay when a compressor is ready to start. If non-zero, this is the time delay in which the EXV valve is allowed to open before the compressor starts. Refer to section on EXV control.

23.11. PID Example Setpoint Defaults

Default **Celsius** values for Suction Superheat with DX Chiller Barrel.

#	SETPOINT	VALUE	TIME	SEC ignore	WINDOW EXT	SAFETY EXT	HI ZONE	LOW ZONE	SETBACK	TYPE
9	SucSprHtTarg	6.5C	6 S	-	-	-	3.0C	2.7C	0.0C	TARGET
10	Ki-IntegMult	0.20	0 S	-	-	-	2.20	-2.20	0.10	TARGET
12	Kp-PropMult	0.45	0 S	-	-	-	0.00	0.00	0.20	TARGET
13	Kd-DerrMult	0.15	0 S	-	-	-	0.20	-0.20	0.17	TARGET
14	Ka-AccMult	.10	0 S	-	-	-	0.00	0.00	0.00	TARGET
15	ExvMinValve%	5.0%	-	-	-	-	-	-	-	SETPOINT
16	ExvMaxValve%	100	0 S	-	-	-	0.0%	0.0%	15.0%	TARGET
17	LO SUPERHEAT	1.6F	120 S	15	300	60	-	-	-	LOCKOUT
19	ExvKiDelay	15s	-	-	-	-	-	-	-	SETPOINT
20	ExvStartup	10s	5 S	-	-	-	-	-	-	TIME

Below setpoints are the default **Fahrenheit** values for Suction Superheat with DX Chiller Barrel.

#	SETPOINT	VALUE	TIME	SEC Ignore	WINDOW EXT	SAFETY EXT	HI ZONE	LOW ZONE	SET-BACK	TYPE
9	SucSprHtTarg	12.0F	6 S	-	-	-	4.0F	3.5F	0.0F	TARGET
10	Ki-IntegMult	0.15	0 S	-	-	-	2.20	-2.20	0.10	TARGET
12	Kp-PropMult	0.30	0 S	-	-	-	0.00	0.00	0.20	TARGET
13	Kd-DerrMult	0.20	0 S	-	-	-	0.20	-0.20	0.17	TARGET
14	Ka-AccMult	0.10	0 S	-	-	-	0.00	0.00	0.00	TARGET
15	ExvMinValve%	5.0%	-	-	-	-	-	-	-	SETPOINT
16	ExvMaxValve%	100	0 S	-	-	-	0.0%	0.0%	15.0%	TARGET
17	LO SUPERHEAT	3.5F	120 S	15	300	60	-	-	-	LOCKOUT
19	ExvKiDelay	15s	-	-	-	-	-	-	-	SETPOINT
20	ExvStartup	10s	5 S	-	-	-	-	-	-	TIME

23.11.1 Subcooler EXV Results

- > If you have selected PID and have a subcooler this will use set points 65 through 72. If you setup 'Subcooler EXV & Subcooler Suction PSI' MCS-Config will automatically complete set points 65 through 72 with MCS standard defaults.
- > If this is an existing config and you are converting to PID set points 253 through 255 will be spared out. (HVAC only)

EXV Control Setpoints																					
#	Name	Value	Min	Max	Adjust Value	Time (SEC)	Max Time Allowed (SEC)	Lockout Delay (HRS)	Safety Down Time(MIN)	Active or Non-Active	Select Value: # decimals & print char	Level Of Auth. To Display	Type of Setpoint	Comments	SEC to Ignore Safety	Window to Ext. Safety Time(SEC)	Safety Time Extension (SEC)	High Zone	Low Zone	Setback	Unit
65	SCExvTarget	19	12	22	0.5	6	12	0	0	Active	TEMP	Service L	Target					4	3.5	0	
66	SCExvKIntegr	0.25	0	3	0.01	0	0	0	0	Active	DEC2NOCH	Service L	Target					2	-1	0.2	
67	SCExvKProp	0.35	0	3	0.01	0	0	0	0	Active	DEC2NOCH	Service L	Target					0	0	0.3	
68	SCExvKDeriv	0.25	0	3	0.01	0	0	0	0	Active	DEC2NOCH	Service L	Target					0.5	-0.5	0.2	
69	SCExvKAccel	0.1	0	3	0.01	0	0	0	0	Active	DEC2NOCH	Service L	Target					0	0	0	
70	SCLowSprht	5	3	8	0.5	120	300	2	10	Active	TEMP	Service L	Alarm								
71	SCExvKiDelay	10	1	90	1	0	0	0	0	Active	SECONDS	Service L	Setpoint								
72	SCExvStartup	10	1	120	1	0	0	0	0	Active	SECONDS	Service L	Setpoint								

- Set Points if PID is selected & you have a Sub Cooler
- Set Points 65 thru 72 are set up
- Degrees F or C are automatic

65	EXV ZONE1	Temperature differential used to build the EXV Zone 1 both plus and minus.
	SCExvTarget	SC SUPERHEAT TARGET - SC SUPERHEAT AVERAGE THIS # SECONDS - <u>Setup as Target</u>
66	EXV ZONE2	Temperature differential that is used to build the EXV Zone 2 both plus and minus. Temperatures above this zone are considered in zone 3.
	SCExvKIntegr	SC SUPERHEAT CONTROL ZONE - SC MPLY Ki) FOR VALVE ADJ WHEN IN FAST ZONE- <u>Setup as Target</u>
67		The EXV control logic will compare the value of this Setpoint to the temperature rate of change to determine the valve adjustment when the temperature is within the EXV control zone. 'Safety Down Time (MIN)' field: The minimum time delay between EXV adjustments when in the EXV control zone.
	SCExvKProp	SC SUPERHEAT MULTIPLIER (Kp) -SC RATE OF CHG MULTIPLIER - <u>Setup as Target</u>

68	EXV ROC ZONE1	The EXV control logic will compare the value of this Setpoint to the temperature rate of change to determine the valve adjustment when the temperature is within zone 1. 'Safety Down Time (MIN)' field: This is the minimum time delay between EXV adjustments when in the EXV control zone 1. If this Setpoint is inactive then the ROC for this zone is 0 and the delay is 15 seconds.
	SCExvKDeriv	SC ADJUST LIMIT IN FAST ZONE (Kd) Velocity of Superheat - SC OUTSIDE FAST ZONE ADJ LIMIT
69	EXV ROC ZONE2	The EXV control logic will compare the value of this Setpoint to the temperature rate of change to determine the valve adjustment when the temperature is within zone 2. 'Safety Down Time (MIN)' field: This is the minimum time delay between EXV adjustments when in the EXV control zone 2. If this Setpoint is inactive then the ROC for this zone is 0 and the delay is 15 seconds.
	SCExvKAccel	<u>Setup as Target</u>
70	EXV ROC ZONE3	The EXV control logic will compare the value of this Setpoint to the temperature rate of change to determine the valve adjustment when the temperature is within zone 3. 'Safety Down Time (MIN)' field: This is the minimum time delay between EXV adjustments when in the EXV control zone 3. If this Setpoint is inactive then the ROC for this zone is 0 and the delay is 15 seconds.
	SCLowSprht	SC LOW SUPERHEAT SAFETY - SC LOW SH TIME TO SAFETY - <u>Setup as Alarm</u>
71	EXV TOO FAST	When the superheat is with the control zone, the EXV control logic will compare the value of this Setpoint to the temperature rate of change to determine the valve adjustment when the temperature is within the zone and rising too fast. 'Safety Down Time (MIN)' field: This is the minimum time delay between EXV adjustments if the rate of change is too fast when in EXV control zones 1 or 2. If this Setpoint is inactive then the ROC for this zone is 0 and the delay is 15 seconds.
	SCExvKiDelay	SC SECONDS DELAY BETWEEN ADJUSTMENTS (Ki) - <u>Setup as Setpoint</u>
72	EXV CHANGING	When the superheat is with the control zone, the EXV control logic will compare the value of this Setpoint to the temperature rate of change to determine the valve adjustment when the temperature is within the zone and rising.

23.12. EXV PID Ki Delay Timer and Ki Accumulator

Magnum firmware 17.63 and greater adds support for two new EXV PID Ki adjustment options.

#1 Reset the Ki Delay Timer – only reset the Ki delay when a 0.1 or greater or -0.1 or less adjustment occurs, vs resetting it when Ki is not equal to zero. This is the reset time when the Ki adjustment is enough to actual move the EXV 0.1% or more.

#2 Ki Accumulator – this keeps the second decimal point in the Ki adjustment and accumulator until an actual adjustment is made, adjust is greater 0.1 or less than -0.1.

Both of these change are designed to help Ki adjustments when very close to the target.

The screenshot displays the 'Magnum HVAC Information Screen' with the 'Evaporator Information' panel selected. The interface includes several sub-sections:

- Capacity Control:** Control Method (Cut In/Out, Control Zone), Cooling Control On (Entering Temp, Leaving Temp), Heating Control On (Entering Temp, Leaving Temp), Target Reset (Ice Mode, Normal), Target (SP #1) Reset, Refrigerant Type (R134A).
- Pump/Fan:** Pump/Fan #1A, #1B, #2A, #2B; Flow Switch A, B; Water PSI IN A, B; Water PSI OUT A, B; Water PSI Status A, B.
- Process Control:** Process Output Type (Modulating, Staged), Process Control Type (VFD, ByPass Valve), On With Circuit Valve? (Yes, No), Process Pump Relay #1, #2, VFD Speed AO #1, #2, Pressure SI IN #1, #2, Pressure SI OUT #1, #2, VFD Fault #1, #2.
- Subcooler Valve Control (highlighted):** Type of Subcooler Valve in Use (None, AO(Open When Off), RO Type, AO(Closed When Off)).
- Heat Control:** Defrost Type (None), Reheat Control (Not Used), Barrel Heater Relay (Not Used).
- EXV Control (highlighted):** Control By The Lowest Superheat In The Suction Group (Yes, No); Ki Adjustment Delay Reset (Ki Adj. NOT = 0, Ki Adj. >= 0.10 OR <= -0.10); Ki Adjustment Accumulator (No Accumulator, Accumulate Values < 0.10).

23.13. Logic to Determine which K Multipliers to Use

- Calculations are done every second

23.13.1.1. Switching to Fast K multipliers is based on:

a. Distance from target

- If current superheat is greater than (setpoint #9 value field plus setpoint #9 high zone field x 2)

Setpoint	Value		Hi Zone		Total
#9 SucSprHtTarg	12.0F	+	4.0F x 2	=	20

EXV PID algorithm will use the fast multipliers (Setpoint Value Field)

- If current superheat value is less than (setpoint #9 value field minus setpoint #9 high zone field)

Setpoint	Current Superheat Value		HI Zone		Total
#9 SucSprHtTarg	12.0F	-	4.0F	=	8

EXV PID algorithm will use the fast multipliers (Setpoint Value Field)

#	SetPoints	Value	Time	SEC Ig...	windo...	safety ...	HI zone	LOW z...	Setback
9	SucSprHtTarg	12.0F	6 S	----	----	----	4.0F	3.5F	0.0F
10	Ki-IntegMult	0.10	0 S	----	----	----	2.20	-2.20	0.10
12	Kp-PropMult	0.30	0 S	----	----	----	0.00	0.00	0.20
13	Kd-DerrMult	0.17	0 S	----	----	----	0.20	-0.20	0.17
14	Ka-AccMult	0.10	0 S	----	----	----	0.00	0.00	0.00

FAST multipliers

23.13.1.2. Switching to Slow K multipliers is based on:

b. Distance from target

- If current superheat is less than (setpoint #9 value field plus setpoint #9 low zone field) but above the fast multiplier switch of 8 (12 - 4)

Setpoint	Value		LOW Zone		Total
#9 SucSprHtTarg	12.0F	+	3.5F	=	15.5F

EXV PID algorithm will use the slow multipliers (Setback Value Field)

- If current superheat is more than (setpoint #9 value field minus setpoint #9 low zone field) and below the fast multiplier switch of 20 (12 + 4 x 2)

Setpoint	Value		LOW Zone		Total
#9 SucSprHtTarg	12.0F	-	3.5F	=	8.5

EXV PID algorithm will use the slow multipliers (Setback Value Field)

#	SetPoints	Value	Time	SEC Ig...	windo...	safety ...	HI zone	LOW z...	Setback
9	SucSprHtTarg	12.0F	6 S	----	----	----	4.0F	3.5F	0.0F
10	Ki-IntegMult	0.10	0 S	----	----	----	2.20	-2.20	0.10
12	Kp-PropMult	0.30	0 S	----	----	----	0.00	0.00	0.20
13	Kd-DerrMult	0.17	0 S	----	----	----	0.20	-0.20	0.17
14	Ka-AccMult	0.10	0 S	----	----	----	0.00	0.00	0.00

SLOW multipliers

23.13.1 Rate of Change_- Moving too Fast

1. If current superheat ROC is greater than setpoint #13 (Kd) high zone and current superheat is above target

Current Superheat ROC	Setpoint #13 High Zone	Current Superheat
0.7	.20	16F

EXV PID algorithm will use the fast multipliers (Setpoint Value Field)

2. If current superheat ROC is greater than setpoint #13 (Kd) low zone and current superheat is below target

Current Superheat ROC	Setpoint #13 Low Zone	Current Superheat value
-0.3	-0.20	8

EXV PID algorithm will use the fast multipliers (Setpoint Value Field)

#	SetPoints	Value	Time	SEC Ig...	windo...	safety ...	HI zone	LOW z...	Setback
9	SucSprHTarg	12.0F	6 S	-----	-----	-----	4.0F	3.5F	0.0F
10	Ki-IntegMult	0.10	0 S	-----	-----	-----	2.20	-2.20	0.10
12	Kp-PropMult	0.30	0 S	-----	-----	-----	0.00	0.00	0.20
13	Kd-DerrMult	0.17	0 S	-----	-----	-----	0.20	-0.20	0.17
14	Ka-AccMult	0.10	0 S	-----	-----	-----	0.00	0.00	0.00

FAST multipliers

23.13.2 Rate of Change - Moving Slow Enough

If current superheat ROC is less than setpoint #13 (Kd) high zone and current superheat is above target

Current Superheat ROC	Setpoint #13 High Zone	Current Superheat
0.1	0.20	15F

EXV PID algorithm will use slow multipliers (Setback Field)

If current superheat ROC is less than setpoint #13 (Kd) low zone and current superheat is below target

Current Superheat ROC	Setpoint #13 Low Zone	Current Superheat
-0.1	-0.20	10

EXV PID algorithm will use slow multipliers (Setback Field)

#	SetPoints	Value	Time	SEC Ig...	windo...	safety ...	HI zone	LOW z...	Setback
9	SucSprHTarg	12.0F	6 S	-----	-----	-----	4.0F	3.5F	0.0F
10	Ki-IntegMult	0.10	0 S	-----	-----	-----	2.20	-2.20	0.10
12	Kp-PropMult	0.30	0 S	-----	-----	-----	0.00	0.00	0.20
13	Kd-DerrMult	0.17	0 S	-----	-----	-----	0.20	-0.20	0.17
14	Ka-AccMult	0.10	0 S	-----	-----	-----	0.00	0.00	0.00

SLOW multipliers

23.14. MCS-Connect Evaporator EXV PID Status

Proportional Adjustment
(Current Superheat minus Superheat from last second) x Kp
Kp = setpoint #12/#67 value (fast) or setback value (slow)

Acceleration Adjustment
(Current Kd minus Kd from x seconds ago) x Ka
Ka = setpoint #14/#69 value (fast) or setback value (slow)

Total Adjust
Adjustment made to current EXV position

System Status

Controlling parameter		Step Delay	Wanted %	Rate of Change	Control On	Mode	Ref Type							
		170	61.0	0.1	WTR OUT = 47.7F	COOLING	R134a							
State	Time	PSI Diff	FLA %	Steps	Lead?	Manual Speed %	Condenser Adjustment							
1) CMP IS RUNNING	00:42:43	86.1P	36%	1		N/A	-							
2) SWITCHED OFF	23:47:26	-9.3P	0%	0	Yes	N/A	-							
Evap EXV State	Time	Valve %	Control On Suct Supht	SuperHeat ROC	ADJ Delay	EXV Target (Adjusted)	Prop. Adj.	Int. Adj.	Der. Adj.	Accel. Adj.	Total Adj.	Kp	Ki	Kd
1) EXV IS OPENING	00:00:03	51.8%	15.5	0.7	15	12.0	0.00	0.00	0.17	0.02	0.1	0.50	0.10	0.25
2) EXV IS CLOSED	00:49:14	0.0%	18.3	-0.1	0	12.0	0.00	0.00	0.00	0.00	0.0	1.00	0.10	0.25
Economizer EXV State	Time	Valve %	Control On Suct Supht	SuperHeat ROC	ADJ Delay									
1) EXV IS CL				0.7	-30									
2) EXV IS CL				0.0	-30									

Integral Adjustment
(Current Superheat minus Superheat Target setpoint #9 value) x Ki
Ki = setpoint #10/#66 value (fast) or setback value (slow)

Derivative Adjustment
(Current Superheat minus Superheat from x seconds ago) x Kd
Kd = setpoint #13/#68 value (fast) or setback value (slow)

Current K multipliers being used

23.15. Allowing an Adjustments to the EXV Valve

(When Ki & Kd are in opposite, we are going in the right direction)

1. When the Proportional adjust, Integral adjust, Derivative adjust and Acceleration all add up to be \geq to .1 or \leq -.1, the adjustment is made based on that number.
2. The Proportional adjust, Derivative adjust and Acceleration all run every second.
3. The Integral adjust uses setpoint #19 (ExvKiDelay) as a delay before posting a value as long as;
 - a. If the current Integral adjust (Ki) is > 0 and the current superheat $>$ the current target plus setpoint #10 high zone field.
 - b. If the current Integral adjust (Ki) is < 0 and the target superheat $<$ the current target plus setpoint #10 low zone.

Ki adjust HiZone
12 plus 2.20 = 14.2

14.2°F

12°F Superheat Target

9.8°F

Ki adjust LOW zone
12 plus -2.20 = 9.8

No
Ki
Adjust in
this area

#	SetPoints	Value	Time	SEC Ig...	windo...	safety ...	HI zone	LOW z...	Setback	MIN VFD	MAX VFD	MAX V...	Type
9	SucSprHtTarg	12.0F	6 S	----	----	----	4.0F	3.5F	0.0F	----	----	----	TARGET
10	Ki-IntegMult	0.10	0 S	----	----	----	2.20	-2.20	0.10	----	----	----	TARGET

Chapter - 24. EXV Level Control using PID

- The following versions of Firmware are needed to setup EXV Level Control:
- MCS-CONFIG – 17.17.00U or later
- MCS-CONNECT – 17.003.11 or later
- MCS-MAGNUM Firmware - 17.16C or later

24.1. Setting up EXV Level Control

- Setup Analog Outputs to control electronic expansion valves.

Analog Output Information Screen									
Point Number	Name	Control Type	Invert	Comments	Modbus Display Type	Feedback Sensor			
M-1	EEV-1	Standard	NO		Spare	Not Used			
M-2	EEV-2	Standard	NO		Spare	Not Used			

- Setup INPUTS to read evaporator or condenser level.

Sensor Input Information Screen									
Point Number	Name (1 to 10 char)	Display Type	Offset	Manual Value or NC/NO (select to change)	Display Text (select to change)	Temp. / GPM / CFM / Pwr Factor SI	Humd./PSI/ Temp. Diff. / Enthal. Diff.	Auto/Manual (Click here for all)	Circuit Index
1-12	REFLVL1	User Defined	0	0	Not Used	Not Used	Not Used	Auto	Not Used
1-13	REFLVL2	User Defined	0	0	Not Used	Not Used	Not Used	Auto	Not Used

24.1.1 Setting up EXV Level Control – User Defined

- Selecting 'User Defined' type

Sensor Input Information Screen									
Point Number	Name (1 to 10 char)	Display Type	Offset	Manual Value or NC/NO (select to change)	Display Text (select to change)	Temp. / GPM / CFM / Pwr Factor SI	Humd./PSI/ Temp. Diff. / Enthal. Diff.	Auto/Manual (Click here for all)	Circuit Index
1-12	REFLVL1	User Defined	0	0	Not Used	Not Used	Not Used	Auto	Not Used
1-13	REFLVL2	User Defined	0	0	Not Used	Not Used	Not Used	Auto	Not Used
1-14	BARLTMP1	User Logic	0	0	Not Used	Not Used	Not Used	Auto	Not Used
1-15	BARLTMP2	VirtualVane%	0	0	Not Used	Not Used	Not Used	Auto	Not Used
1-16	SPARE	VOLT5DC	0	0	Not Used	Not Used	Not Used	Auto	Not Used
2-1	SPARE2-1	0-600 VAC	0	0	Not Used	Not Used	Not Used	Auto	Not Used
		600VAC4	0	0	Not Used	Not Used	Not Used	Auto	Not Used

Under the Display Type, select User Defined

- Screen below will open:

SI Calculation Wizard

Select Display Type (Do this FIRST)

HUMID or %

	Voltage	=	Value
Point #1	1.2	=	0%
Point #2	3.7	=	100%

Calculate Cancel

1. Setting up the Level Sensor
2. Wire the Level Sensor to the designated input.
3. If available, have the Level Sensor loose and manually move the float or submerge in a bucket of liquid to 100% (standpipe full of refrigerant).
4. Record the voltage input, this would be point #2 on the SI Calculation Wizard
(Ex. Voltage = 3.7 Value = 100%)
5. Move the float to 0% (no refrigerant in the standpipe=empty)
6. Record the voltage input. This would be point #1 on the SI calculation wizard
(Ex. Voltage = 1.2 Value = 0%)

NOTE: If Level Sensor is a 4-20ma output, where at 4ma = 0% level and at 20ma = 100% level, you would put the designated input jumper on digital and the SI calculation wizard would be Setup as:

Point #1 .882 vdc = 0%

Point #2 4.41 vdc = 100%

See APP066- 4-20mA Sensor Connection to MCS-Magnum

24.1.2 Circuit Base Setup

- Point to the EXV outputs in the Circuit Base screen.

MAGNUM Circuit Base Screen

Information that relates to compressors on the circuit

Circuit# (reset button)	# of Comp RDs	Starting Compressor RO	Part Winding	Start Unload Bypass	Fast Unloader	Type of LLS	2nd LLS	Comp. Economizer (Subcooler)	Econo Control	Unloading Stages	Loader Type	HGB	HG Reheat	Liquid Injection	Oil Equalization	Mod Motor Control	Low Disc SuperHeat	External Oil Pump Control
1	3	COMP-1	No	No	No	EXV only	No	No	Slide 2	0	Unload	None	No	No	No	No	No	No
2	3	COMP-2	No	No	No	EXV only	No	No	Slide 2	0	Unload	None	No	No	No	No	No	No
3	0	Not Used	No	No	No	None	No	No	Slide 2	0	Unload	None	No	No	No	No	No	No
4	0	Not Used	No	No	No	None	No	No	Slide 2	0	Unload	None	No	No	No	No	No	No
5	0	Not Used	No	No	No	None	No	No	Slide 2	0	Unload	None	No	No	No	No	No	No
6	0	Not Used	No	No	No	None	No	No	Slide 2	0	Unload	None	No	No	No	No	No	No
7	0	Not Used	No	No	No	None	No	No	Slide 2	0	Unload	None	No	No	No	No	No	No
8	0	Not Used	No	No	No	None	No	No	Slide 2	0	Unload	None	No	No	No	No	No	No

Select Output and Sensor Inputs per circuit

Circuit # (reset button)	Alarm Relay	Comp Proof	Compr Speed(%) or Modulate Hot Gas AP	Compressor Speed Fault	Slide Closed Indicator	Pump Down	Evaporator EXV Output	Flow	Pump/Valve Proof	Circuit Pump/Valve	IGV Open %	Reheat Type	Reheat AD	Reheat RO	Amount of RD's	Reh Fat
1	Not Used	Not Used	Not Used	Not Used	Not Used	PUMPDW	EEV-1	WFS+FT	Not Used	Not Used	Not Used	None	Not Used	Not Used	0	Not Us
2	Not Used	Not Used	Not Used	Not Used	Not Used	PUMPDW	EEV-2	WFS+AFT	Not Used	Not Used	Not Used	None	Not Used	Not Used	0	Not Us
3	Not Used	Not Used	Not Used	Not Used	Not Used	Not Used	Not Used	WATER IN	Not Used	Not Used	Not Used	None	Not Used	Not Used	0	Not Us

- Point to the Refrigerant Level inputs in the Circuit SI screen.

MAGNUM Circuit SI Screen

Circuit # (reset button)	Oil Seal Temp	Pre Oil Filter	Oil Float	Leaving Temp	Refrigerant Temp	Refrig Level	Refrig. Leak Sensor	Vane Position	Evap Suct Temp	Eva
1	Not Used	Not Used	OILLVL1	Not Used	BARLTMP1	REFLVL1	Not Used	Not Used	Not Used	Not
2	Not Used	Not Used	OILLVL2	Not Used	BARLTMP2	REFLVL2	Not Used	Not Used	Not Used	Not
3	Not Used	Not Used	Not Used	Not Used	Not Used	Not Used	Not Used	Not Used	Not Used	Not

- Make sure the Discharge Pressure and Discharge Temperature are pointing to correct sensors for the calculation of discharge superheat.

MAGNUM Circuit SI Screen

Circuit # (reset button)	Suction Pressure	Discharge Pressure	Suction Temperature	Discharge Temperature	Oil Pressure	Oil Temp	Motor Temp	Oil Flow Switch	Liquid Temp	L Pre
1	SUCPRES1	DISPRES1	SUCTEMP1	DISTEMP1	Not Used	WIND.TEMP	MP+OL1	Not Used	Not Used	Not U
2	SUCPRES2	DISPRES2	SUCTEMP2	DISTEMP2	Not Used	WIND.TEMP	MP+OL2	Not Used	Not Used	Not U
3	Not Used	Not Used	Not Used	Not Used	Not Used	Not Used	Not Used	Not Used	Not Used	Not U

24.1.3 Setup using EXV CONTROL WIZARD

- Select the EXV Control button and set up for level control with the desired EXV control method.

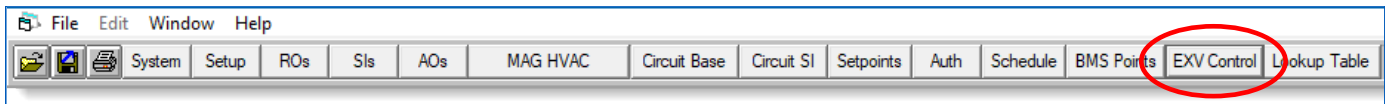

Heat Exchanger Type
Flooded Barrel

EXV Control Wizard

Control Parameter

- Suction Superheat
- Discharge Superheat
- Evaporator Level
- Condenser Level
- Approach

Heat Exchanger Type

- None
- DX Coil
- Plate HX
- DX Barrel
- Flooded Barrel

Control Method

- Normal (Original)
- Fc21
- Fc211
- PID

Target Modifier

- Low Discharge Superheat
- Oversized Condenser/High Ambient
- Maximum Operating Pressure(MOP)
- Minimum Differential Pressure(MDP)
- Target Reset
- Low Suction
- Low/High Level
- Level->CAP

Set Default Values?
Firmware Version 17.56 or Higher Required

MCS Defaults

User Defaults

Create Defaults File

Control Parameter

Select Evaporator Level or Condenser Level

Control Method

PID

Set Default Values

Click MCS DEFAULTS

- The following setpoints will be setup:

Setpoint Information Screen																				
#	Name	Value	Min	Max	Adjust Value	Time (SEC)	Max Time Allowed (SEC)	Lockout Delay (HRS)	Safety Down Time(MIN)	Active or Non-Active	Select Value: # decimals & print char	Level Of Auth. To Display	Type of Setpoint	Comments	SEC to Ignore Safety	Window to Ext. Safety Time(SEC)	Safety Time Extension (SEC)	High Zone	Low Zone	Setback
9	EvpLevelTarg	40	25	70	1	6	9	0	0	Active	... HUMD or %	Service L1	Target	...	---	---	---	0.1	1	0
10	Ki-IntegMult	0.13	0	3	0.01	0	0	0	0	Active	... DEC2NOCH	Service L1	Target	...	---	---	---	1	-1	0.1
11	EXV LD/UNLD%	0	0	0.5	0.1	0	0	0	0	Non-Active	... HUMD or %	Service L1	Time	...	---	---	---	---	---	---
12	Kp-PropMult	0.15	0	3	0.01	0	0	0	0	Active	... DEC2NOCH	Service L1	Target	...	---	---	---	0	0	0.2
13	Kd-DerivMult	0.03	0	3	0.01	0	0	0	0	Active	... DEC2NOCH	Service L1	Target	...	---	---	---	0.6	-0.6	0.05
14	Ka-AccelMult	0.05	0	3	0.01	0	0	0	0	Active	... DEC2NOCH	Service L1	Target	...	---	---	---	0	0	0
15	ExvMinValve%	5	2	25	1	2	10	0	0	Active	... HUMD or %	Service L1	Setpoint	...	---	---	---	---	---	---
16	ExvMaxValve%	100	50	100	1	0	0	0	0	Active	... HUMD or %	Service L1	Target	...	---	---	---	0	0	10
17	LO Suc sprht	1	-20	4	0.1	120	900	2	10	Non-Active	... TEMP	Service L1	Lockout	...	15	300	60	---	---	---
18	LOW PSI DELY	1	1	30	1	3	60	0	0	Non-Active	... SECONDS	Service L1	Time	...	---	---	---	---	---	---
19	ExvKiDelay	90	1	120	1	0	0	0	0	Active	... SECONDS	Service L1	Setpoint	...	---	---	---	---	---	---
20	ExvStartup	30	5	45	1	5	10	0	0	Active	... SECONDS	Service L1	Time	...	---	---	---	---	---	---

- NOTE: If more than one circuit is available and you want to control two independent circuit target levels, make setpoint#9 'Non-Active' in the setpoint screen.
- Make the used FLA setpoints#171-190 a 'target' type and set the level target up in the setback field.

Setpoint Information Screen																				
#	Name	Value	Min	Max	Adjust Value	Time (SEC)	Max Time Allowed (SEC)	Lockout Delay (HRS)	Safety Down Time(MIN)	Active or Non-Active	Select Value: # decimals & print char	Level Of Auth. To Display	Type of Setpoint	Comments	SEC to Ignore Safety	Window to Ext. Safety Time(SEC)	Safety Time Extension (SEC)	High Zone	Low Zone	Setback
171	FLA COMP#1	292	200	300	1	1	1	0	0	Active	... AMPS/CT	Factory L1	Target	...	---	---	---	0	0	42
172	FLA COMP#2	292	200	300	1	1	1	0	0	Active	... AMPS/CT	Factory L1	Target	...	---	---	---	0	0	34

24.1.4 Low Discharge Superheat EXV Target Adjust Logic

- Requires Firmware Version: MCS-MAGNUM Firmware - 17.61-D or later

Below are three enables for the low discharge EXV target adjustment:



7. Comp has been running for 5 minutes, or
8. Discharge temperature is greater than 130F (or 54.5C), or
9. EXV control is setup for PID Evap, PID Cond, Old Evap Level or Old Cond Level control.

- Make setpoint #110 (LoDisSHExvAd) active if you want to dynamically change the EXV target based on Low Discharge Superheat.

Setpoint Information Screen																				
#	Name	Value	Min	Max	Adjust Value	Time (SEC)	Max Time Allowed (SEC)	Lockout Delay (HRS)	Safety Down Time(MIN)	Active or Non-Active	Select Value: # decimals & print char	Level Of Auth. To Display	Type of Setpoint	Comments	SEC to Ignore Safety	Window to Ext. Safety Time(SEC)	Safety Time Extension (SEC)	High Zone	Low Zone	Setback
109	HiRefLevel	95	50	100	1	120	120	2	10	Active	... HUMD or %	Factory L1	Lockout	...	600	300	60	---	---	---
110	LoDisSHExvAd	0.5	0.1	5	0.1	90	300	0	0	Active	... HUMD or %	Factory L1	Target	...	---	---	---	45	10	30
111	FREEZE	38	36	40	1	3	10	0	0	Active	... TEMP	Factory L1	Lockout	...	0	0	0	---	---	---

24.1.4.1. The Low Discharge Superheat logic:

- If Setpoint #110 (#164 for REFR) is setup as a "TARGET" type setpoint the following logic occurs (New Logic):

1. If discharge superheat <= setpoint #110 (#164) low zone value and the low discharge superheat adjusted amount is less than the max adjust limit setpoint #110 setback value and the Time (SEC) value has elapsed, then:
 - a. If Evap Level control, setpoint #110 (#164) value field is subtracted from the EXV Target and this value becomes the new EXV target. The value in the Time (SEC) field will count down again and

another adjustment will be made until the max adjust is reached (setpoint #110 setback value) or the discharge superheat goes above setpoint #110 (#164) low zone value.

- b. For Cond Level control method, setpoint #110 (#164) value field is added to the EXV Target and this value becomes the new EXV Target. The value in the Time (SEC) field will count down again and another adjustment will be made until the max adjust is reached (setpoint #110 setback value) or the discharge superheat goes above setpoint #110 (#164) low zone value.
- Else if discharge superheat \geq setpoint #110 (#164) high zone value and the low discharge superheat adjusted amount is greater than 0 and the Time (SEC) value has elapsed, then:
 - a. If Evap Level control, setpoint #110 (#164) value field is added to the EXV Target and this value becomes the new EXV Target. The value in the Time (SEC) field will count down again and another adjustment will be made until the min adjust is reached (0) or the discharge superheat goes below setpoint #110 (#164) high zone value.

NOTE: The EXV Target adjusted value will not go above the original setpoint Target value.

- b. For Cond Level control method, setpoint #110 (#164) value field is subtracted from the EXV Target and this value becomes the new EXV Target. The value in the Time (SEC) field will count down again and another adjustment will be made until the min adjust is reached (0) or the discharge superheat goes below setpoint #110 (#164) high zone value.

NOTE: The EXV Target adjusted value will not go below the original setpoint Target value.

- Else If Setpoint #110 (#164) is not a "TARGET" type setpoint the following logic occurs (Old Logic):
2. If discharge superheat is $<$ Low discharge superheat safety setpoint #84 value, then:
 - a. If Evap Level or Cond Level and not level target by compressor circuit, then set EXV target to setpoint #110 value.
 - b. Else If Evap Level or Cond Level and EXV target is by compressor circuit, then subtract setpoint #110 value from the current EXV target.

Chapter - 25. Analog Output Control using PID

Required to have the software below or later version
 Config version 18.01T
 Connect version 18.31.15
 Firmware HVAC 17.62R2

PID control will turn an analog output into a stand alone PID controlled output. This output will have a controlling sensor that modulates the AO to a maintain target. This logic will run all the time.

Analog Output Information Screen			
Point Number	Name	Control Type	Invert
4-4	ExvTpCtrl1	PID CTRL	NO
5-1	ExvTpCtrl2	Standard	NO
5-2	ExvTpCtrl3	PID CTRL	NO
5-3	SPARE5-3	Linear CTRL	NO
5-4	SPARE5-4	Modbus	NO
6-1	SPARE6-1	Digital Scroll	NO
6-2	SPARE6-2	2-10vdc	NO
		Linear/Modbus	NO

PID CTRL AO User Logic

ExvTpCtrl1 (0% to 100%)

If Relay- is Off, then Output =

Else

Control Sensor		Control Target	
Point	Value	Point	Value
SI	SupplyTmp1	Setpoint Val	AHU1TrgtTmp

AO = To

Minimum Output (0% to 100%) Max Output (0% to 100%)

Proportional (Kp)	
(-327.68 to 327.67)	
Mult.	<input type="text" value="0.1"/>

Integral (Ki)	
(-327.68 to 327.67) (0 to 3200)	
Mult.	<input type="text" value="0.7"/>
Delay	<input type="text" value="60"/>

Derivative (Kd)	
(-327.68 to 327.67) (2 to 60)	
Mult.	<input type="text" value="0.15"/>
Interval	<input type="text" value="6"/>

Adjustment Limits	
(-0.1 to -100.0) (0.1 to 100.0)	
Min Adj	<input type="text" value="-5"/>
Max Adj	<input type="text" value="5"/>

NOTE

If AO is modulating the wrong direction, simply make all three multipliers negative values to reverse the direction the AO modulates and vice versa.

If Relay-

If a relay is used and is OFF then associated AO will be set to the defined value and not modulate. If 'not used' the logic is ignored.

Control Sensor

AO or SI point to be used as the controlling sensor for the AO.

Control Target

SI, AO, or Setpoint used as the target the AO will try to maintain.

AO

Min to Max value the AO can modulate between.

Proportional(Kp)

Multiplier for Kp adjustments.

Integral(Ki)

Multiplier and delay between Ki Adjustments

Derivative(Kd)

Multiplier and time in seconds interval to calculate Kd.

Adjustment Limits

Min and Max adjustments allowed to the AO per adjustment, both negative and positive.

Under the Analog Outputs window in the MCS Connect software. You'll find an AO PID tab that will show all of the PID CONTROL AOs and all of the calculated adjustments being made to those Analog Outputs. Here you will be able to see all three adjustments being made to the PID. This will assist you in any fine tuning required for the given analog output.

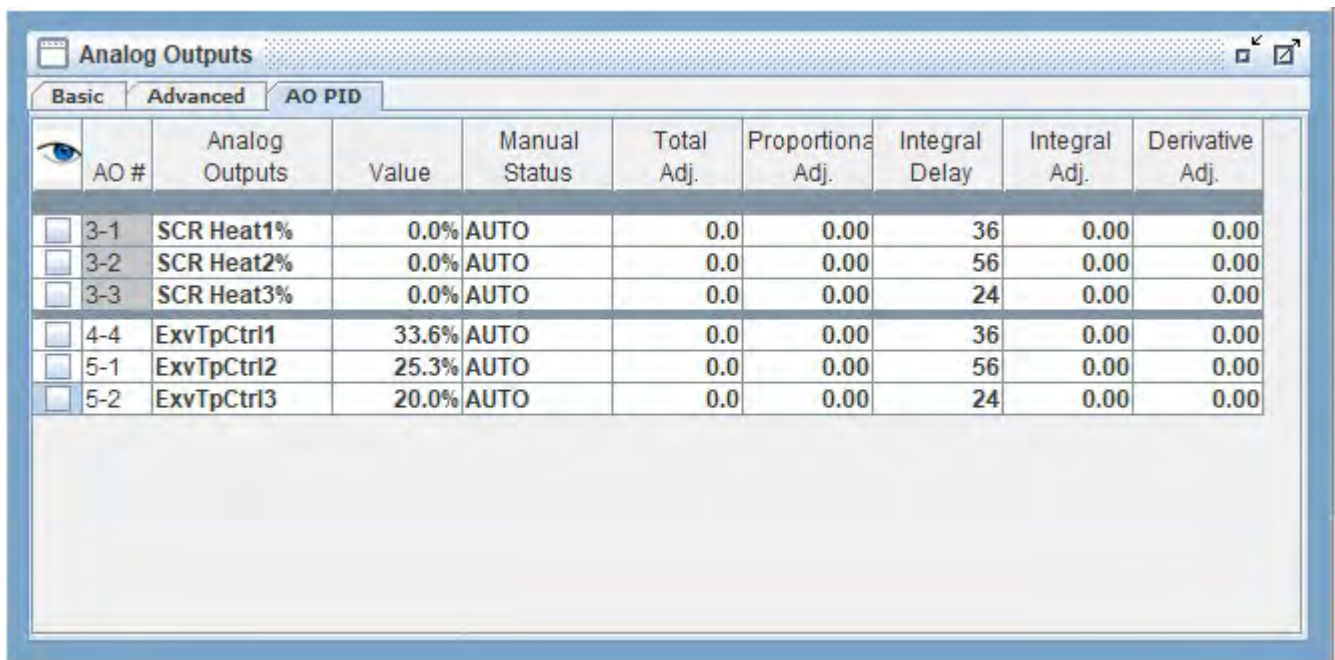

AO #	Analog Outputs	Value	Manual Status	Total Adj.	Proportional Adj.	Integral Delay	Integral Adj.	Derivative Adj.
3-1	SCR Heat1%	0.0%	AUTO	0.0	0.00	36	0.00	0.00
3-2	SCR Heat2%	0.0%	AUTO	0.0	0.00	56	0.00	0.00
3-3	SCR Heat3%	0.0%	AUTO	0.0	0.00	24	0.00	0.00
4-4	ExvTpCtrl1	33.6%	AUTO	0.0	0.00	36	0.00	0.00
5-1	ExvTpCtrl2	25.3%	AUTO	0.0	0.00	56	0.00	0.00
5-2	ExvTpCtrl3	20.0%	AUTO	0.0	0.00	24	0.00	0.00

Chapter - 26. BMS Communication Protocols

The MCS-Magnum supports as standard: BACnet IP, Modbus RTU, and Modbus TCP/IP protocols.

Using the MCS-BMS-GATEWAY, the MCS-Magnum can also support Johnson N2, LonTalk and Bacnet MSTP.

Supported baud rates for Modbus RTU and Johnson N2 are 4800bps, 9600bps, 19200bps, 38400bps, and 57600bps.

26.1. MCS-Magnum to BMS Connections

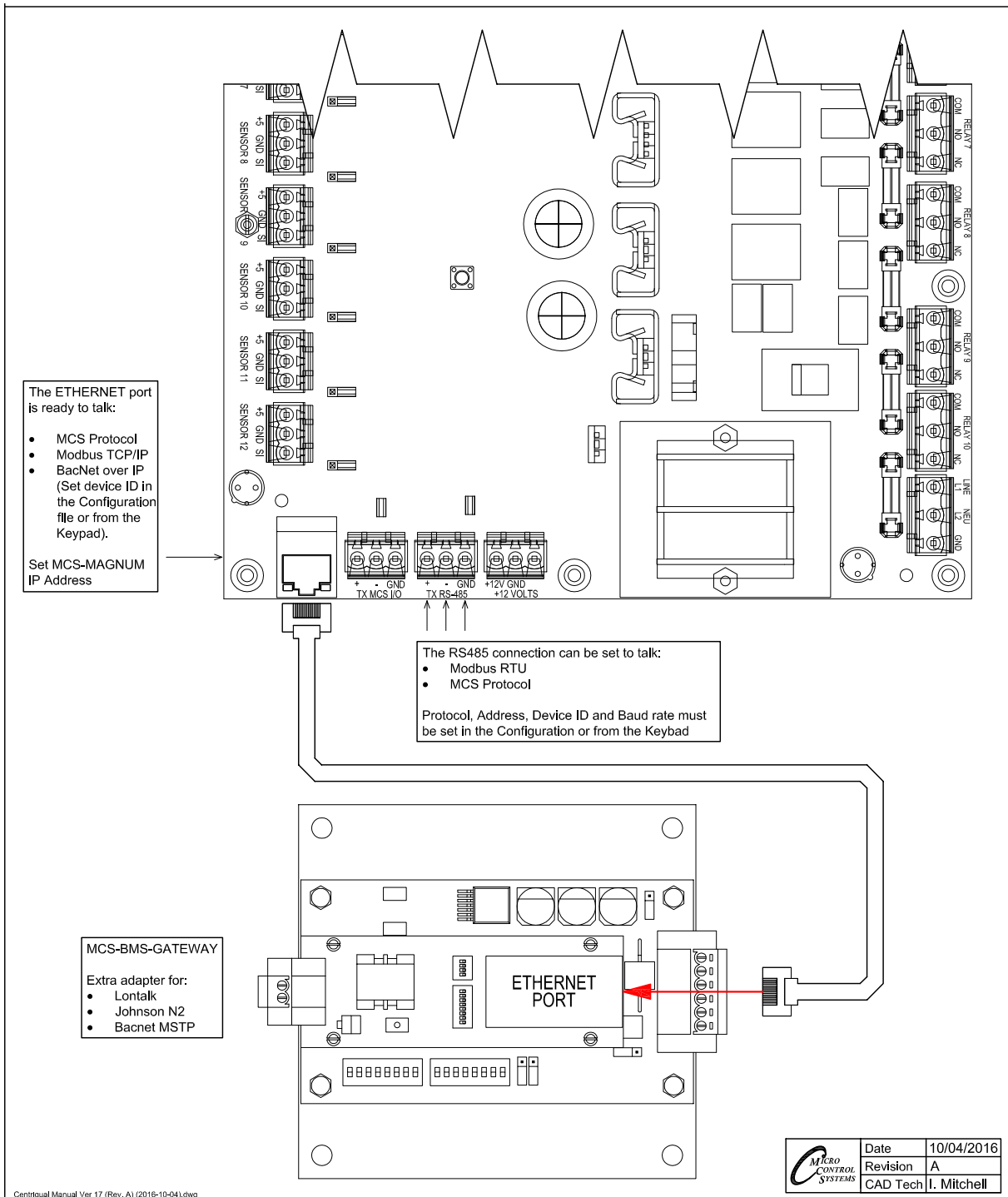

Centrigual Manual Ver 17 (Rev. A) (2016-10-04).dwg

26.2. Sensor Input Points

Sensor numbering is based upon the MCS-MAGNUM or SI16-AO4 hardware type board Notable BACnet properties available: Units

Magnum	BACnet ID	BACnet Name	Modbus Register	N2
Sensor M-1	AI: 1	Refer to Config	*30001	*AI: 1
Sensor M-2	AI: 2	Refer to Config	*30002	*AI: 2
Sensor M-3	AI: 3	Refer to Config	*30003	*AI: 3
Sensor M-4	AI: 4	Refer to Config	*30004	*AI: 4
Sensor M-5	AI: 5	Refer to Config	*30005	*AI: 5
Sensor M-6	AI: 6	Refer to Config	*30006	*AI: 6
Sensor M-7	AI: 7	Refer to Config	*30007	*AI: 7
Sensor M-8	AI: 8	Refer to Config	*30008	*AI: 8
Sensor M-9	AI: 9	Refer to Config	*30009	*AI: 9
Sensor M-10	AI:10	Refer to Config	*30010	*AI: 10
Sensor M-11	AI:11	Refer to Config	*30011	*AI: 11
Sensor M-12	AI:12	Refer to Config	*30012	*AI: 12
Sensor M-13	AI:13	Refer to Config	*30013	*AI: 13
Sensor M-14	AI:14	Refer to Config	*30014	*AI: 14
Sensor M-15	AI:15	Refer to Config	*30015	*AI: 15
Sensor M-16	AI:16	Refer to Config	*30016	*AI: 16
Sensor 1-1	AI:17	Refer to Config	*30017	*AI: 17
Sensor 1-2	AI:18	Refer to Config	*30018	*AI: 18
Sensor 1-3	AI:19	Refer to Config	*30019	*AI: 19
Sensor 1-4	AI:20	Refer to Config	*30020	*AI: 20
Sensor 1-5	AI:21	Refer to Config	*30021	*AI: 21
Sensor 1-6	AI:22	Refer to Config	*30022	*AI: 22
Sensor 1-7	AI:23	Refer to Config	*30023	*AI: 23
Sensor 1-8	AI:24	Refer to Config	*30024	*AI: 24
Sensor 1-9	AI:25	Refer to Config	*30025	*AI: 25
Sensor 1-10	AI:26	Refer to Config	*30026	*AI: 26
Sensor 1-11	AI:27	Refer to Config	*30027	*AI: 27
Sensor 1-12	AI:28	Refer to Config	*30028	*AI: 28
Sensor 1-13	AI:29	Refer to Config	*30029	*AI: 29
Sensor 1-14	AI:30	Refer to Config	*30030	*AI: 30
Sensor 1-15	AI:31	Refer to Config	*30031	*AI: 31
Sensor 1-16	AI:32	Refer to Config	*30032	*AI: 32
Sensor 2-1	AI:33	Refer to Config	*30033	*AI: 33
Sensor 2-2	AI:34	Refer to Config	*30034	*AI: 34
Sensor 2-3	AI:35	Refer to Config	*30035	*AI: 35
Sensor 2-4	AI:36	Refer to Config	*30036	*AI: 36
Sensor 2-5	AI:37	Refer to Config	*30037	*AI: 37
Sensor 2-6	AI:38	Refer to Config	*30038	*AI: 38
Sensor 2-7	AI:39	Refer to Config	*30039	*AI: 39
Sensor 2-8	AI:40	Refer to Config	*30040	*AI: 40

Magnum	BACnet ID	BACnet Name	Modbus Register	N2
Sensor 2-9	AI:41	Refer to Config	*30041	*AI: 41
Sensor 2-10	AI:42	Refer to Config	*30042	*AI: 42
Sensor 2-11	AI:43	Refer to Config	*30043	*AI: 43
Sensor 2-12	AI:44	Refer to Config	*30044	*AI: 44
Sensor 2-13	AI:45	Refer to Config	*30045	*AI: 45
Sensor 2-14	AI:46	Refer to Config	*30046	*AI: 46
Sensor 2-15	AI:47	Refer to Config	*30047	*AI: 47
Sensor 2-16	AI:48	Refer to Config	*30048	*AI: 48
Sensor 3-1	AI:49	Refer to Config	*30049	*AI:49
Sensor 3-2	AI:50	Refer to Config	*30050	*AI: 50
Sensor 3-3	AI:51	Refer to Config	*30051	*AI: 51
Sensor 3-4	AI:52	Refer to Config	*30052	*AI: 52
Sensor 3-5	AI:53	Refer to Config	*30053	*AI: 53
Sensor 3-6	AI:54	Refer to Config	*30054	*AI: 54
Sensor 3-7	AI:55	Refer to Config	*30055	*AI: 55
Sensor 3-8	AI:56	Refer to Config	*30056	*AI: 56
Sensor 3-9	AI:57	Refer to Config	*30057	*AI: 57
Sensor 3-10	AI:58	Refer to Config	*30058	*AI: 58
Sensor 3-11	AI:59	Refer to Config	*30059	*AI: 59
Sensor 3-12	AI:60	Refer to Config	*30060	*AI: 60
Sensor 3-13	AI:61	Refer to Config	*30061	*AI: 61
Sensor 3-14	AI:62	Refer to Config	*30062	*AI: 62
Sensor 3-15	AI:63	Refer to Config	*30063	*AI: 63
Sensor 3-16	AI:64	Refer to Config	*30064	*AI: 64
Sensor 4-1	AI:65	Refer to Config	*30065	*AI: 65
Sensor 4-2	AI:66	Refer to Config	*30066	*AI: 66
Sensor 4-3	AI:67	Refer to Config	*30067	*AI: 67
Sensor 4-4	AI:68	Refer to Config	*30068	*AI: 68
Sensor 4-5	AI:69	Refer to Config	*30069	*AI: 69
Sensor 4-6	AI:70	Refer to Config	*30070	*AI: 70
Sensor 4-7	AI:71	Refer to Config	*30071	*AI: 71
Sensor 4-8	AI:72	Refer to Config	*30072	*AI: 72
Sensor 4-9	AI:73	Refer to Config	*30073	*AI: 73
Sensor 4-10	AI:74	Refer to Config	*30074	*AI: 74
Sensor 4-11	AI:75	Refer to Config	*30075	*AI: 75
Sensor 4-12	AI:76	Refer to Config	*30076	*AI: 76
Sensor 4-13	AI:77	Refer to Config	*30077	*AI: 77
Sensor 4-14	AI:78	Refer to Config	*30078	*AI: 78
Sensor 4-15	AI:79	Refer to Config	*30079	*AI: 79
Sensor 4-16	AI:80	Refer to Config	*30080	*AI: 80

*- Indicates value multiplied by 10 to include one decimal place. (I.e. BMS value of 500 indicates actual value 50.0)

26.3. Relay Output Points

Relay Output points are read-only. Sensor numbering is based upon RO-10 hardware type board

Magnum	BACnet ID	BACnet Name	Modbus	N2
Relay M-1	BO: 1	Refer to Config	00001	BO: 1
Relay M-2	BO: 2	Refer to Config	00002	BO: 2
Relay M-3	BO: 3	Refer to Config	00003	BO: 3
Relay M-4	BO: 4	Refer to Config	00004	BO: 4
Relay M-5	BO: 5	Refer to Config	00005	BO: 5
Relay M-6	BO: 6	Refer to Config	00006	BO: 6
Relay M-7	BO: 7	Refer to Config	00007	BO: 7
Relay M-8	BO: 8	Refer to Config	00008	BO: 8
Relay M-9	BO: 9	Refer to Config	00009	BO: 9
Relay M-10	BO:10	Refer to Config	00010	BO: 10
Relay 1-1	BO:11	Refer to Config	00011	BO: 11
Relay 1-2	BO:12	Refer to Config	00012	BO: 12
Relay 1-3	BO:13	Refer to Config	00013	BO: 13
Relay 1-4	BO:14	Refer to Config	00014	BO: 14
Relay 1-5	BO:15	Refer to Config	00015	BO: 15
Relay 1-6	BO:16	Refer to Config	00016	BO: 16
Relay 1-7	BO:17	Refer to Config	00017	BO: 17
Relay 1-8	BO:18	Refer to Config	00018	BO: 18
Relay 1-9	BO:19	Refer to Config	00019	BO: 19
Relay 1-10	BO:20	Refer to Config	00020	BO: 20
Relay 2-1	BO:21	Refer to Config	00021	BO: 21
Relay 2-2	BO:22	Refer to Config	00022	BO: 22
Relay 2-3	BO:23	Refer to Config	00023	BO: 23
Relay 2-4	BO:24	Refer to Config	00024	BO: 24
Relay 2-5	BO:25	Refer to Config	00025	BO: 25
Relay 2-6	BO:26	Refer to Config	00026	BO: 26
Relay 2-7	BO:27	Refer to Config	00027	BO: 27
Relay 2-8	BO:28	Refer to Config	00028	BO: 28
Relay 2-9	BO:29	Refer to Config	00029	BO: 29
Relay 2-10	BO:30	Refer to Config	00030	BO: 30
Relay 3-1	BO:31	Refer to Config	00031	BO: 31
Relay 3-2	BO:32	Refer to Config	00032	BO: 32
Relay 3-3	BO:33	Refer to Config	00033	BO: 33
Relay 3-4	BO:34	Refer to Config	00034	BO: 34
Relay 3-5	BO:35	Refer to Config	00035	BO: 35
Relay 3-6	BO:36	Refer to Config	00036	BO: 36
Relay 3-7	BO:37	Refer to Config	00037	BO: 37
Relay 3-8	BO:38	Refer to Config	00038	BO: 38
Relay 3-9	BO:39	Refer to Config	00039	BO: 39
Relay 3-10	BO:40	Refer to Config	00040	BO: 40

Magnum	BACnet ID	BACnet Name	Modbus	N2
Relay 4-1	BO:41	Refer to Config	00041	BO: 41
Relay 4-2	BO:42	Refer to Config	00042	BO: 42
Relay 4-3	BO:43	Refer to Config	00043	BO: 43
Relay 4-4	BO:44	Refer to Config	00044	BO: 44
Relay 4-5	BO:45	Refer to Config	00045	BO: 45
Relay 4-6	BO:46	Refer to Config	00046	BO: 46
Relay 4-7	BO:47	Refer to Config	00047	BO: 47
Relay 4-8	BO:48	Refer to Config	00048	BO: 48
Relay 4-9	BO:49	Refer to Config	00049	BO: 49
Relay 4-10	BO:50	Refer to Config	00050	BO: 50
Relay 5-1	BO:51	Refer to Config	00051	BO: 51
Relay 5-2	BO:52	Refer to Config	00052	BO: 52
Relay 5-3	BO:53	Refer to Config	00053	BO: 53
Relay 5-4	BO:54	Refer to Config	00054	BO: 54
Relay 5-5	BO:55	Refer to Config	00055	BO: 55
Relay 5-6	BO:56	Refer to Config	00056	BO: 56
Relay 5-7	BO:57	Refer to Config	00057	BO: 57
Relay 5-8	BO:58	Refer to Config	00058	BO: 58
Relay 5-9	BO:59	Refer to Config	00059	BO: 59
Relay 5-10	BO:60	Refer to Config	00060	BO: 60
Relay 6-1	BO:61	Refer to Config	00061	BO: 61
Relay 6-2	BO:62	Refer to Config	00062	BO: 62
Relay 6-3	BO:63	Refer to Config	00063	BO: 63
Relay 6-4	BO:64	Refer to Config	00064	BO: 64
Relay 6-5	BO:65	Refer to Config	00065	BO: 65
Relay 6-6	BO:66	Refer to Config	00066	BO: 66
Relay 6-7	BO:67	Refer to Config	00067	BO: 67
Relay 6-8	BO:68	Refer to Config	00068	BO: 68
Relay 6-9	BO:69	Refer to Config	00069	BO: 69
Relay 6-10	BO:70	Refer to Config	00760	BO: 70
Relay 7-1	BO:71	Refer to Config	00071	BO: 71
Relay 7-2	BO:72	Refer to Config	00072	BO: 72
Relay 7-3	BO:73	Refer to Config	00073	BO: 73
Relay 7-4	BO:74	Refer to Config	00074	BO: 74
Relay 7-5	BO:75	Refer to Config	00075	BO: 75
Relay 7-6	BO:76	Refer to Config	00076	BO: 76
Relay 7-7	BO:77	Refer to Config	00077	BO: 77
Relay 7-8	BO:78	Refer to Config	00078	BO: 78
Relay 7-9	BO:79	Refer to Config	00079	BO: 79
Relay 7-10	BO:80	Refer to Config	00070	BO: 80

*- Indicates value multiplied by 10 to include one decimal place. (I.e. BMS value of 500 indicates actual value 50.0)

Analog Output Points Analog Output points are read-only. Sensor numbering is based upon SI16-AO4 hardware type board. Notable BACnet properties available: Units

Magnum	BACnet ID	BACnet Name	Modbus Register	N2
Analog Out M-1	AO:1	Refer to Config	*30201	*AO: 1
Analog Out M-2	AO:2	Refer to Config	*30202	*AO: 2
Analog Out M-3	AO:3	Refer to Config	*30203	*AO: 3
Analog Out M-4	AO:4	Refer to Config	*30204	*AO: 4
Analog Out 1-1	AO:5	Refer to Config	*30205	*AO: 5
Analog Out 1-2	AO:6	Refer to Config	*30206	*AO: 6
Analog Out 1-3	AO:7	Refer to Config	*30207	*AO: 7
Analog Out 1-4	AO:7	Refer to Config	*30208	*AO: 8
Analog Out 2-1	AO:8	Refer to Config	*30209	*AO: 9
Analog Out 2-2	AO:10	Refer to Config	*30210	*AO: 10
Analog Out 2-3	AO:11	Refer to Config	*30211	*AO: 11
Analog Out 2-4	AO:12	Refer to Config	*30212	*AO: 12
Analog Out 3-1	AO:13	Refer to Config	*30213	*AO: 13
Analog Out 3-2	AO:14	Refer to Config	*30214	*AO: 14
Analog Out 3-3	AO:15	Refer to Config	*30215	*AO: 15
Analog Out 3-4	AO:16	Refer to Config	*30216	*AO: 16
Analog Out 4-1	AO:17	Refer to Config	*30217	*AO: 17
Analog Out 4-2	AO:18	Refer to Config	*30218	*AO: 18
Analog Out 4-3	AO:19	Refer to Config	*30219	*AO: 19
Analog Out 4-4	AO:20	Refer to Config	*30220	*AO: 20

*- Indicates value multiplied by 10 to include one decimal place. (I.e. BMS value of 500 indicates actual value 50.0)

26.4. Setpoints

Setpoints are read-only. Notable BACnet properties available: Units

Magnum	BACnet ID	BACnet Name	Modbus	N2
Setpoint #1	AV:0	STP# 1-<Setpoint name>	40301	ADF:1
Setpoint #21	AV:88	STP# 21-<Setpoint name>	40321	ADF:89
Setpoint #163	AV:230	STP# 163-<Setpoint name>	40463	ADF:231

*- Indicates value multiplied by 10 to include one decimal place. (I.e. BMS value of 500 indicates actual value 50.0)

26.5. Chiller/Compressor States

State values are read-only. Notable BACnet properties available: Number of States, State-Text (Contains character text of current state)

Magnum	BACnet ID	BACnet Name	Modbus Register	N2
Chiller Unit State	MV:0	CHILLER STATE	30306	BYT:1
Compressor #1 State	MV:1	COMPRESSOR #1 STATE	30307	BYT:2
Compressor #2 State	MV:2	COMPRESSOR #2 STATE	30308	BYT:3
Compressor #3 State	MV:3	COMPRESSOR #3 STATE	30309	BYT:4
Compressor #4 State	MV:4	COMPRESSOR #4 STATE	30310	BYT:5
Compressor #5 State	MV:5	COMPRESSOR #5 STATE	30311	BYT:6
Compressor #6 State	MV:6	COMPRESSOR #6 STATE	30312	BYT:7

Magnum	BACnet ID	BACnet Name	Modbus Register	N2
Compressor #7 State	MV:7	COMPRESSOR #7 STATE	30313	BYT:8
Compressor #8 State	MV:8	COMPRESSOR #8 STATE	30314	BYT:9
Compressor #9 State	MV:130	COMPRESSOR #9 STATE	30560	BYT:131
Compressor #10 State	MV:131	COMPRESSOR #10 STATE	30561	BYT:132
Compressor #11 State	MV:132	COMPRESSOR #11 STATE	30562	BYT:133
Compressor #12 State	MV:133	COMPRESSOR #12 STATE	30563	BYT:134
Compressor #13 State	MV:134	COMPRESSOR #13 STATE	30564	BYT:135
Compressor #14 State	MV:135	COMPRESSOR #14 STATE	30565	BYT:136
Compressor #15 State	MV:136	COMPRESSOR #15 STATE	30566	BYT:137
Compressor #16 State	MV:137	COMPRESSOR #16 STATE	30567	BYT:138
Compressor #17 State	MV:138	COMPRESSOR #17 STATE	30568	BYT:139
Compressor #18 State	MV:139	COMPRESSOR #18 STATE	30569	BYT:140
Compressor #19 State	MV:140	COMPRESSOR #19 STATE	30570	BYT:141
Compressor #20 State	MV:141	COMPRESSOR #20 STATE	30571	BYT:142

26.6. Other Points

These points are read-only.

Magnum	BACnet ID	BACnet Name	Modbus	N2
Wanted FLA%	AV:3	Wanted FLA%	30318	ADF:4
Steps Wanted	AV:4	Steps Wanted On	30315	ADF:5
Steps On	AV:5	Steps On	30316	ADF:6
Step Delay	AV:6	Step Delay	30317	ADF:7
Compressor #1 FLA%	AV:7	C1_FLA%	*30319	*ADF:8
Compressor #1 Sat Suction	AV:10	C1_Sat Suct	*30327	*ADF:11
Compressor #1 Sat Disch	AV:11	C1_Sat Disch	*30329	*ADF:12
Compressor #1 Disch SH	AV:12	C1_Disch SH	*30330	*ADF:13
Compressor #1 Suct SH	AV:13	C1_Suct SH	*30328	*ADF:14
Compressor #1 Oil Pres Diff	AV:63	C1_Oil Pres Diff	*30375	*ADF:64
Compressor #2 FLA%	AV:14	C2_FLA%	*30320	*ADF:15
Compressor #2 Sat Suction	AV:17	C2_Sat Suct	*30331	*ADF:18
Compressor #2 Sat Disch	AV:18	C2_Sat Disch	*30333	*ADF:19
Compressor #2 Disch SH	AV:19	C2_Disch SH	*30334	*ADF:20
Compressor #2 Suct SH	AV:20	C2_Suct SH	*30332	*ADF:21
Compressor #2 Oil Pres Diff	AV:64	C2_Oil Pres Diff	*30376	*ADF:65
Compressor #3 FLA%	AV:21	C3_FLA%	*30321	*ADF:22
Compressor #3 Sat Suction	AV:24	C3_Sat Suct	*30335	*ADF:25
Compressor #3 Sat Disch	AV:25	C3_Sat Disch	*30337	*ADF:26
Compressor #3 Disch SH	AV:26	C3_Disch SH	*30338	*ADF:27
Compressor #3 Suct SH	AV:27	C3_Suct SH	*30336	*ADF:28
Compressor #3 Oil Pres Diff	AV:65	C3_Oil Pres Diff	*30377	*ADF:66
Compressor #4 FLA%	AV:28	C4_FLA%	*30322	*ADF:29
Compressor #4 Sat Suction	AV:31	C4_Sat Suct	*30339	*ADF:32
Compressor #4 Sat Disch	AV:32	C4_Sat Disch	*30341	*ADF:33
Compressor #4 Disch SH	AV:33	C4_Disch SH	*30342	*ADF:34
Compressor #4 Suct SH	AV:34	C4_Suct SH	*30340	*ADF:35
Compressor #4 Oil Pres Diff	AV:66	C4_Oil Pres Diff	*30378	*ADF:67
Compressor #5 FLA%	AV:35	C5_FLA%	*30323	*ADF:36

Magnum	BACnet ID	BACnet Name	Modbus	N2
Compressor #5 Sat Suction	AV:38	C5_Sat Suct	*30343	*ADF:39
Compressor #5 Sat Disch	AV:39	C5_ Sat Disch	*30345	*ADF:40
Compressor #5 Disch SH	AV:40	C5_Disch SH	*30346	*ADF:41
Compressor #5 Suct SH	AV:41	C5_Suct SH	*30344	*ADF:42
Compressor #5 Oil Pres Diff	AV:67	C5_Oil Pres Diff	*30379	*ADF:68
Compressor #6 FLA%	AV:42	C6_FLA%	*30324	*ADF:43
Compressor #6 Sat Suction	AV:45	C6_Sat Suct	*30347	*ADF:46
Compressor #6 Sat Disch	AV:46	C6_ Sat Disch	*30349	*ADF:47
Compressor #6 Disch SH	AV:47	C6_Disch SH	*30350	*ADF:48
Compressor #6 Suct SH	AV:48	C6_Suct SH	*30348	*ADF:49
Compressor #6 Oil Pres Diff	AV:68	C6_Oil Pres Diff	*30380	*ADF:69
Compressor #7 FLA%	AV:49	C7_FLA%	*30325	*ADF:50
Compressor #7 Sat Suction	AV:52	C7_Sat Suct	*30351	*ADF:53
Compressor #7 Sat Disch	AV:53	C7_ Sat Disch	*30353	*ADF:54
Compressor #7 Disch SH	AV:54	C7_Disch SH	*30354	*ADF:55
Compressor #7 Suct SH	AV:55	C7_Suct SH	*30352	*ADF:56
Compressor #7 Oil Pres Diff	AV:69	C7_Oil Pres Diff	*30381	*ADF:70
Compressor #8 FLA%	AV:56	C8_FLA%	*30326	*ADF:57
Compressor #8 Sat Suction	AV:59	C8_Sat Suct	*30352	*ADF:53
Compressor #8 Sat Suction	AV:59	C8_Sat Suct	*30355	*ADF:60
Compressor #8 Sat Disch	AV:60	C8_ Sat Disch	*30357	*ADF:61
Compressor #8 Disch SH	AV:61	C8_Disch SH	*30358	*ADF:62
Compressor #8 Suct SH	AV:62	C8_Suct SH	*30356	*ADF:63
Compressor #8 Oil Pres Diff	AV:70	C8_Oil Pres Diff	*30382	*ADF:71
Compressor #9 FLA%	AV:440	C9_FLA%	*30572	*ADF:441
Compressor #9 Sat Suction	AV: 443	C9_Sat Suct	*30584	*ADF: 442
Compressor #9 Sat Disch	AV: 444	C9_ Sat Disch	*30586	*ADF: 443
Compressor #9 Disch SH	AV: 445	C9_Disch SH	*30587	*ADF: 444
Compressor #9 Suct SH	AV: 446	C9_Suct SH	*30585	*ADF: 445
Compressor #9 Oil Pres Diff	AV:524	C9_Oil Pres Diff	*30656	*ADF:525
Compressor #10 FLA%	AV:447	C10_FLA%	*30573	*ADF:448
Compressor #10 Sat Suction	AV: 450	C10_Sat Suct	*30588	*ADF: 451
Compressor #10 Sat Disch	AV: 451	C10_ Sat Disch	*30590	*ADF: 452
Compressor #10 Disch SH	AV: 452	C10_Disch SH	*30591	*ADF: 453
Compressor #10 Suct SH	AV: 453	C10_Suct SH	*30589	*ADF: 454
Compressor #10 Oil Pres Diff	AV:525	C10_Oil Pres Diff	*30657	*ADF:526
Compressor #11 FLA%	AV:454	C11_FLA%	*30574	*ADF:455
Compressor #11 Sat Suction	AV: 457	C11_Sat Suct	*30592	*ADF: 458
Compressor #11 Sat Disch	AV: 458	C11_ Sat Disch	*30594	*ADF: 459
Compressor #11 Disch SH	AV: 459	C11_Disch SH	*30595	*ADF: 460
Compressor #11 Suct SH	AV: 460	C11_Suct SH	*30593	*ADF: 461
Compressor #11 Oil Pres Diff	AV: 526	C11_Oil Pres Diff	*30658	*ADF: 527
Compressor #12 FLA%	AV: 461	C12_FLA%	*30575	*ADF: 462
Compressor #12 Sat Suction	AV: 464	C12_Sat Suct	*30596	*ADF: 465
Compressor #12 Sat Disch	AV: 465	C12_ Sat Disch	*30598	*ADF: 466
Compressor #12 Disch SH	AV: 466	C12_Disch SH	*30599	*ADF: 467
Compressor #12 Suct SH	AV: 467	C12_Suct SH	*30597	*ADF 468
Compressor #12 Oil Pres Diff	AV:527	C12_Oil Pres Diff	*30659	*ADF:528
Compressor #13 FLA%	AV:468	C13_FLA%	*30576	*ADF:469
Compressor #13 Sat Suction	AV: 471	C13_Sat Suct	*30600	*ADF: 470
Compressor #13 Sat Disch	AV: 472	C13_ Sat Disch	*30602	*ADF: 473
Compressor #13 Disch SH	AV: 473	C13_Disch SH	*30603	*ADF: 474

Magnum	BACnet ID	BACnet Name	Modbus	N2
Compressor #13 Suct SH	AV: 474	C13_Suct SH	*30600	*ADF: 475
Compressor #13 Oil Pres Diff	AV: 528	C13_Oil Pres Diff	*30661	*ADF: 529
Compressor #14 FLA%	AV: 475	C14_FLA%	*30577	*ADF: 476
Compressor #14 Sat Suction	AV: 478	C14_Sat Suct	*30604	*ADF: 479
Compressor #14 Sat Disch	AV: 479	C14_Sat Disch	*30606	*ADF: 480
Compressor #14 Disch SH	AV: 480	C14_Disch SH	*30607	*ADF: 481
Compressor #14 Suct SH	AV: 481	C14_Suct SH	*30605	*ADF: 482
Compressor #14 Oil Pres Diff	AV: 529	C14_Oil Pres Diff	*30661	*ADF: 530
Compressor #15 FLA%	AV: 482	C15_FLA%	*30578	*ADF: 483
Compressor #15 Sat Suction	AV: 485	C15_Sat Suct	*30608	*ADF: 486
Compressor #15 Sat Disch	AV: 486	C15_Sat Disch	*30610	*ADF: 487
Compressor #15 Disch SH	AV: 487	C15_Disch SH	*30611	*ADF: 488
Compressor #15 Suct SH	AV: 488	C15_Suct SH	*30609	*ADF: 489
Compressor #15 Oil Pres Diff	AV: 530	C15_Oil Pres Diff	*3062	*ADF: 531
Compressor #16 FLA%	AV: 489	C16_FLA%	*30579	*ADF: 490
Compressor #16 Sat Suction	AV: 492	C16_Sat Suct	*30612	*ADF: 493
Compressor #16 Sat Disch	AV: 493	C16_Sat Disch	*30614	*ADF: 494
Compressor #16 Disch SH	AV: 494	C16_Disch SH	*30615	*ADF: 495
Compressor #16 Suct SH	AV: 495	C16_Suct SH	*30613	*ADF: 496
Compressor #16 Oil Pres Diff	AV: 531	C16_Oil Pres Diff	*30663	*ADF: 532
Compressor #17 FLA%	AV: 496	C17_FLA%	*30580	*ADF: 497
Compressor #17 Sat Suction	AV: 499	C17_Sat Suct	*30616	*ADF: 500
Compressor #17 Sat Disch	AV: 500	C17_Sat Disch	*30618	*ADF: 501
Compressor #17 Disch SH	AV: 501	C17_Disch SH	*30619	*ADF: 502
Compressor #17 Suct SH	AV: 502	C17_Suct SH	*30617	*ADF: 503
Compressor #17 Oil Pres Diff	AV: 532	C17_Oil Pres Diff	*30664	*ADF: 533
Compressor #18 FLA%	AV: 503	C18_FLA%	*30581	*ADF: 504
Compressor #18 Sat Suction	AV: 506	C18_Sat Suct	*30620	*ADF: 507
Compressor #18 Sat Disch	AV: 507	C18_Sat Disch	*30622	*ADF: 508
Compressor #18 Disch SH	AV: 508	C18_Disch SH	*30623	*ADF: 509
Compressor #18 Suct SH	AV: 509	C18_Suct SH	*30621	*ADF: 510
Compressor #18 Oil Pres Diff	AV: 533	C18_Oil Pres Diff	*30665	*ADF: 534
Compressor #19 FLA%	AV: 510	C19_FLA%	*30582	*ADF: 511
Compressor #19 Sat Suction	AV: 513	C19_Sat Suct	*30624	*ADF: 514
Compressor #19 Sat Disch	AV: 514	C19_Sat Disch	*30626	*ADF: 515
Compressor #19 Disch SH	AV: 515	C19_Disch SH	*30627	*ADF: 516
Compressor #19 Suct SH	AV: 516	C19_Suct SH	*30625	*ADF: 517
Compressor #19 Oil Pres Diff	AV: 534	C19_Oil Pres Diff	*30666	*ADF: 535
Compressor #20 FLA%	AV: 517	C20_FLA%	*30583	*ADF: 518
Compressor #20 Sat Suction	AV: 520	C20_Sat Suct	*30628	*ADF: 521
Compressor #20 Sat Disch	AV: 521	C20_Sat Disch	*30630	*ADF: 522
Compressor #20 Disch SH	AV: 522	C20_Disch SH	*30631	*ADF: 523
Compressor #20 Suct SH	AV: 523	C20_Suct SH	*30629	*ADF: 524
Compressor #20 Oil Pres Diff	AV: 535	C20_Oil Pres Diff	*30667	*ADF: 536

*- Indicates value multiplied by 10 to include one decimal place. (I.e. BMS value of 500 indicates actual value 50.0)

26.7. Network inputs to MCS-Magnum

The MCS-Magnum can receive changes from the network to enable or disable the Network Run/Stop, Network Target

Reset (adjustments to the Cooling Target, Setpoint #1, based on Setpoint #21), Network Demand FLA, and Network Demand Steps.

The MCS-Magnum must be setup to accept these inputs. The configuration file must contain a Network Run/Stop, Network Target, Network Demand FLA, and Network Demand Steps sensors.

Magnum	BACnet ID	BACnet Name	Modbus	N2
Network Run/Stop	AV:246	Net_R/S	40201	BO:247
Network Target/Reset	AV:247	Net_Tar/Res	40202	AO:248
Network Demand/FLA	AV:248	Net_Demad_FLA	40204	AO:249
Network Demand/Steps	AV:249	Net_Demad_Steps	40205	AO:250

Note the following Information panel has a Network Run/Stop, and /or Network Target Reset sensors inputs indicated. This is an example of how MCS-Config must be setup in the General Information and Evaporator Information panels.

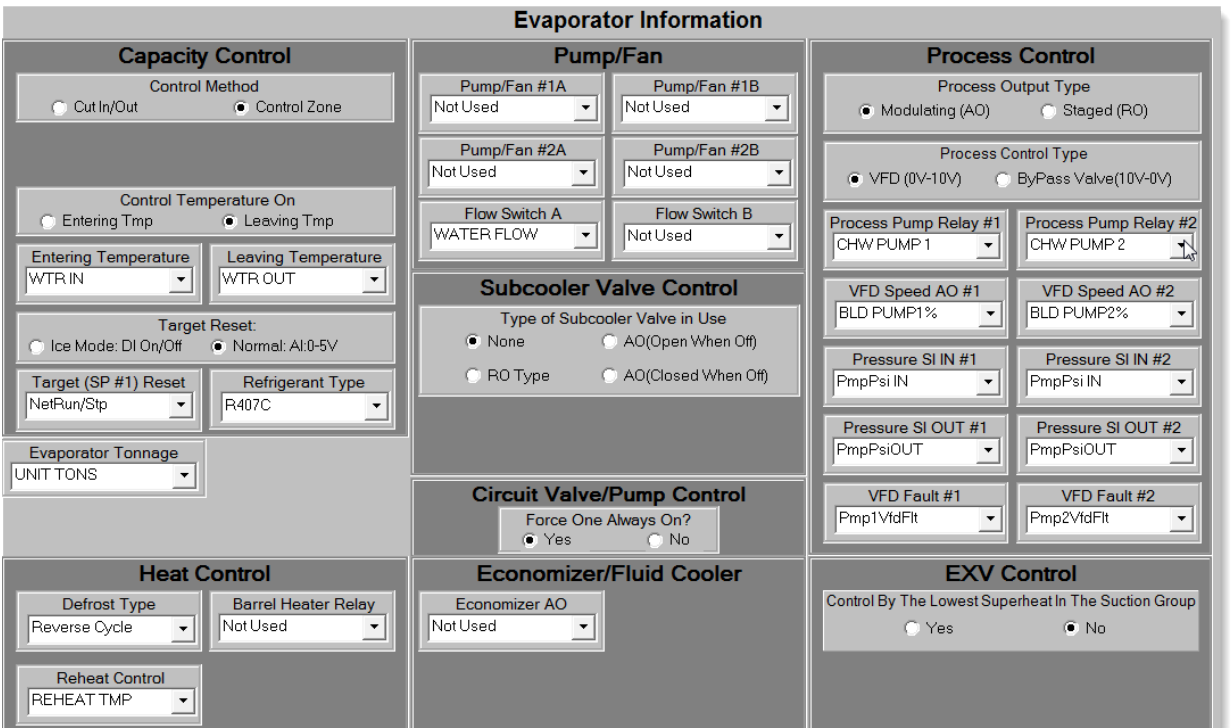
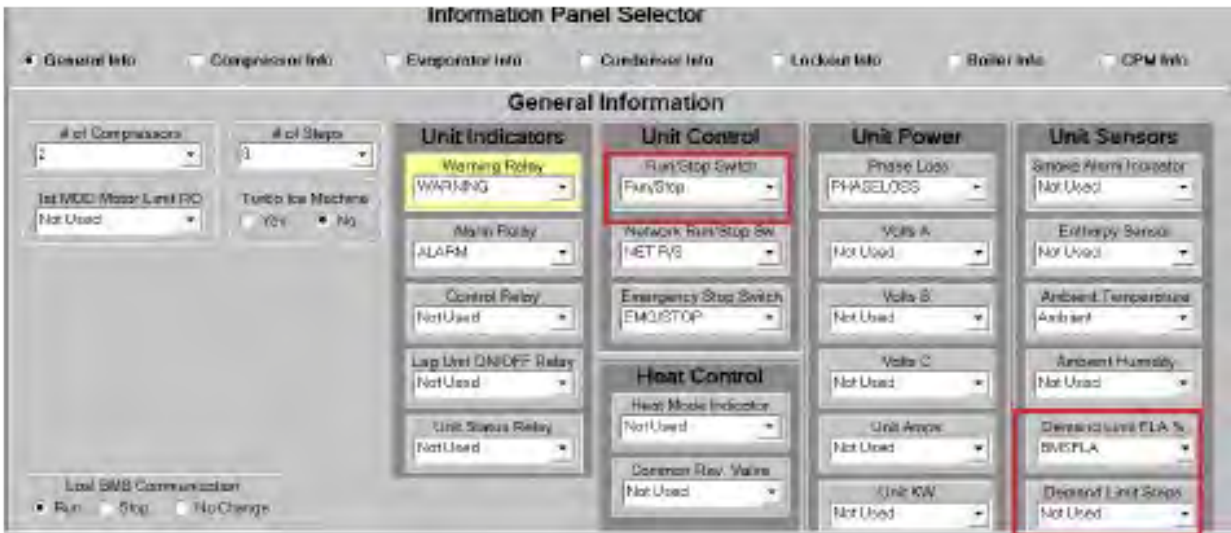

The sensors must be set up as follows (This is only an example)

1-1	BMS R/S	BMS RUN	Not Used	Open=OFF	OFF/ON	Not Used	Not Used	Auto
1-2	BMS TRS	BMS CW RSET	0	0	Not Used	Not Used	Not Used	Auto
1-3	BMSFLA	BMS Dmd FLA%	0	0	Not Used	Not Used	Not Used	Auto
1-4	BMSSteps	BMS Dmd Step	0	0	Not Used	Not Used	Not Used	Auto

26.8. MCS Capacity Control State Chart

The values exposed in the capacity state relate to the descriptions in this table.

State Number	Description
0	" UNIT IN POWER UP"
1	" POWER LOSS DELAY"
2	"NO RUN- I/O LOST"
3	"UNIT IN LOCKOUT"
4	"UNIT IS OFF"
5	"UNIT IS HOLDING"
6	"UNIT UNLDNG-VANE"
7	"UNIT LOADNG-VANE"
8	"OFF-SMOKE ALARM"
9	"RUN/STOP SW OFF"
10	"SCHEDULED OFF"
11	"OFF-NO FLOW(s)"
12	"OFF-NO COND FLOW"
13	"AMBIENT OFF"
14	"PROCESS HEAT OFF"
15	"UNIT IS UNLOADED"
16	"UNIT IS LOADED"
17	"OFF TMP-ICE MADE"
18	"ECONOMIZER ONLY"
19	"VaneOpen-SpdHold"

State Number	Description
20	"UNIT SMOKE UNLDG"
21	"UNIT OFF UNLDING"
22	"UNIT DMD UNLDING"
23	"UNIT HEAT UNLDNG"
24	"UNIT UNLDNG-VFD"
25	" UNIT LOADNG-VFD"
26	"CMP RAMPING UP"
27	"CLOSING BYP VLV"
28	"FACTORY STARTUP"
29	"MAXIMUM RUN TIME"
30	"RTU RUN NORMAL"
31	"OFF-FIRE ALARM"
32	"UNIT HEAT HOLDG"
33	" CMP SPD OPTIMIZE"

26.9. MCS Compressor Control State Chart

The values expressed in the compressor state relate to the descriptions in this table.

State Number	Description
0	"POST OIL LUBE"
1	"CMP LOCKED OUT"
2	"SWITCHED OFF"
3	"CmpShuttingOFF"
4	"CMP ANTICYCLE"
5	"CMP OFF/READY"
6	"OIL PMP LUBING"
7	"CMP IN STARTUP"
8	"CMP UNLOADED"
9	"CMP DECR SPEED"
10	"CMP INCR SPEED"
11	"CMP IS HOLDING"
12	"CMP OPEN VANES"
13	"CMP CLOSE VANES"
14	"CMP IS RUNNING"
15	"FAST UNLOADING"
16	"LO SUCT UNLOAD"
17	"LO SUCT HOLD"
18	"HI DISC UNLOAD"
19	"HI DISC HOLD"
20	"SAFETY TRIPPED"
21	"LO TEMP UNLOAD"
22	"LO TEMP HOLD"

State Number	Description
23	"HI AMP HOLD"
24	"HI DIS TMP HLD"
25	"SURGE SPD/VANE"
26	"LIFT SPD/VANE"
27	"HI WATER HOLD"
28	"EXTRA 70% STEP"
29	"OFF-LO OIL TMP"
30	"HI AMP UNLDING"
31	"DEF PREPMP OUT"
32	"DEFROSTING"
33	"DEF PUMP DOWN"
34	"HI TEMP UNLOAD"
35	"HI TEMP HOLD"
36	"SCROLL STEP 1"
37	"SCROLL STEP 2"
38	"SCROLL STEP 3"
39	"SCROLL STEP 4"
40	"ON OIL RECOVERY"
41	"WAIT P-RATIO"
42	"CMP GROUP OFF"
43	"CLOSING VANES"
44	"TimingVaneOpn"
45	"TimingVaneCls"

26.10. MCS-MAGNUM BMS PROTOCOLS

The following Protocols are available with the Magnum. Changes can be made to the settings using the Keypad or can be made using MCS-CONNECT SERVICE WINDOW.

1. BACnet IP
2. MCS PROTOCOL
3. MODBUS RTU PROTOCOL
4. ETHERNET PROTOCOL (this protocol is always active)
5. MODBUS IP (this protocol is always active)

26.10.1 BACNET OVER IP PROTOCOL

The BACNET DEVICE ID is a five-digit number. The first three digits are based on MCS's Bacnet Vendor ID 181, and the last two are set by the Bacnet/MSTP address.

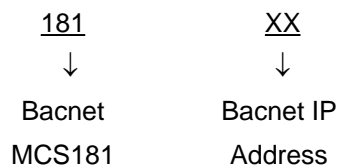

In case the end user would like to set up an ID other than 181-XX, there is an extended BACnet setting that can only be set in MCS Config.

The following changes can be made using the Keypad or can be made using MCS-CONNECT SERVICE WINDOW.

The **BACnet IP** address can be verified and changed (with the proper authorization code) from the Keypad/LCD. The following steps will display the Bacnet IP Network address, and the the TCP/IP port:

- Press the Menu key, select Serv Tools, and then press the Enter key.
- Use **↑** arrow to **BACnet Setting** then press Enter.
- Select address then press Enter. Change the address so it matches the last two digits of the device ID then press Enter.
- Use **↓** arrow to tab to the TCP/IP address.
- Select address then press Enter. Change the address and port to match your device.

26.10.2 ETHERNET NETWORK PROTOCOL

The following steps will display the **ETHERNET NETWORK** settings:

If you are going to manually assign the IP Address, Subnet Mask, and Default Gateway.

- Press the Menu key, select Serv Tools, and then press the Enter key.
- Select Ethernet Network then press Enter.
- Set "DYNAMIC IP" to NO.
- Set the "IP Address".
- Set the "Subnet Mask".
- Set "Default Gateway".
- Reset Magnum for change to take effect.

If you are going to let your network assign the IP Address, Subnet Mask, and Default Gateway.

- Press the Menu key, select Serv Tools, and then press the Enter key.

- Select Ethernet Network then press Enter.
- Set “DYNAMIC IP” to YES.
- Connect the MCS-Magnum to the network and power up the board.

26.10.3 MODBUS RTU PROTOCOL

The Modbus RTU address can be verified and changed (with the proper authorization code) from the keypad/LCD or can be made using MCS-CONNECT SERVICE WINDOW.

The following steps will display the Modbus RTU Network address, and the Baud Rate:

- Press the Menu key, select Serv Tools, and then press the Enter key.
- Select RS485 Network then press Enter.
- Select Protocol then press Enter. Change the protocol to Modbus RTU.
- Select address then press Enter. Change the address then press Enter.
- Select Baud then press Enter. Set the baud rate then press Enter.
- Connect the communication wires to the TX RS485 three-position terminal located above the Ethernet connector.
- Reset Magnum for change to take effect.

26.10.4 MODBUS TCP/IP PROTOCOL

This protocol is always active.

Make sure the MCS-Magnum network settings are set correctly.

If you are going to manually assign the IP Address, Subnet Mask, and Default Gateway.

Press the Menu key, select Serv Tools, and then press the Enter key.

- Select Ethernet Network then press Enter.
- Set “DYNAMIC IP” to NO.
- Set the “IP Address”.
- Set the “Subnet Mask”.
- Set “Default Gateway”.
- Reset Magnum for change to take effect.

If you are going to let your network assign the IP Address, Subnet Mask, and Default Gateway.

- Press the Menu key, select Serv Tools, and then press the Enter key.
- Select Ethernet Network then press Enter.
- Set “DYNAMIC IP” to YES.
- Connect the MCS-Magnum to the network and power up the board.

26.11. PROTOCOLS USING MCS-BMS-GATEWAY

The MCS-BMS-GATEWAY is a microprocessor based communication device that provides translation from BACnet IP to LonTalk, BACnet MSTP, or Johnson Control N2.

Information that can be transmitted includes the status of control points, alarm information, digital inputs, analog inputs or setpoints.

For more information on the MCS-BMS-GATEWAY please go to www.mcscontrols.com.

Chapter - 27. Network Protocols

Network protocols are formatting rules that specify how data is sent and received between devices. Protocols are necessary for devices to interact with each other.

27.1. Protocols MCS controllers support:

1. **BACNET**
2. **MODBUS RTU**
3. **ETHERNET**
4. **MCS**
5. **LONTALK**
6. **JOHNSON N2**

✓ = Built in Support

MCS Network Protocol Support		
	Magnum	MicroMag
Over Ethernet	Bacnet IP	✓ MCS-Bacnet-Router2
	Modbus IP	✓ In Development
	MCS IP	✓ MCS-Ethernet
Over RS485	Modbus RTU	✓ ✓
	MCS 485	✓ ✓
	Bacnet MS/TP	MCS-BMS-Gateway
Over LonWorks	Johnson N2	MCS-BMS-Gateway MCS-BMS-Gateway
	LonTalk	MCS-BMS-Gateway MCS-BMS-Gateway

Requires MCS-BMS-GATEWAY

27.2. MCS-MAGNUM USING RS-485

Using the RS485, the MCS-Magnum can be connected to the BMS (Modbus RTU or MCS 485)

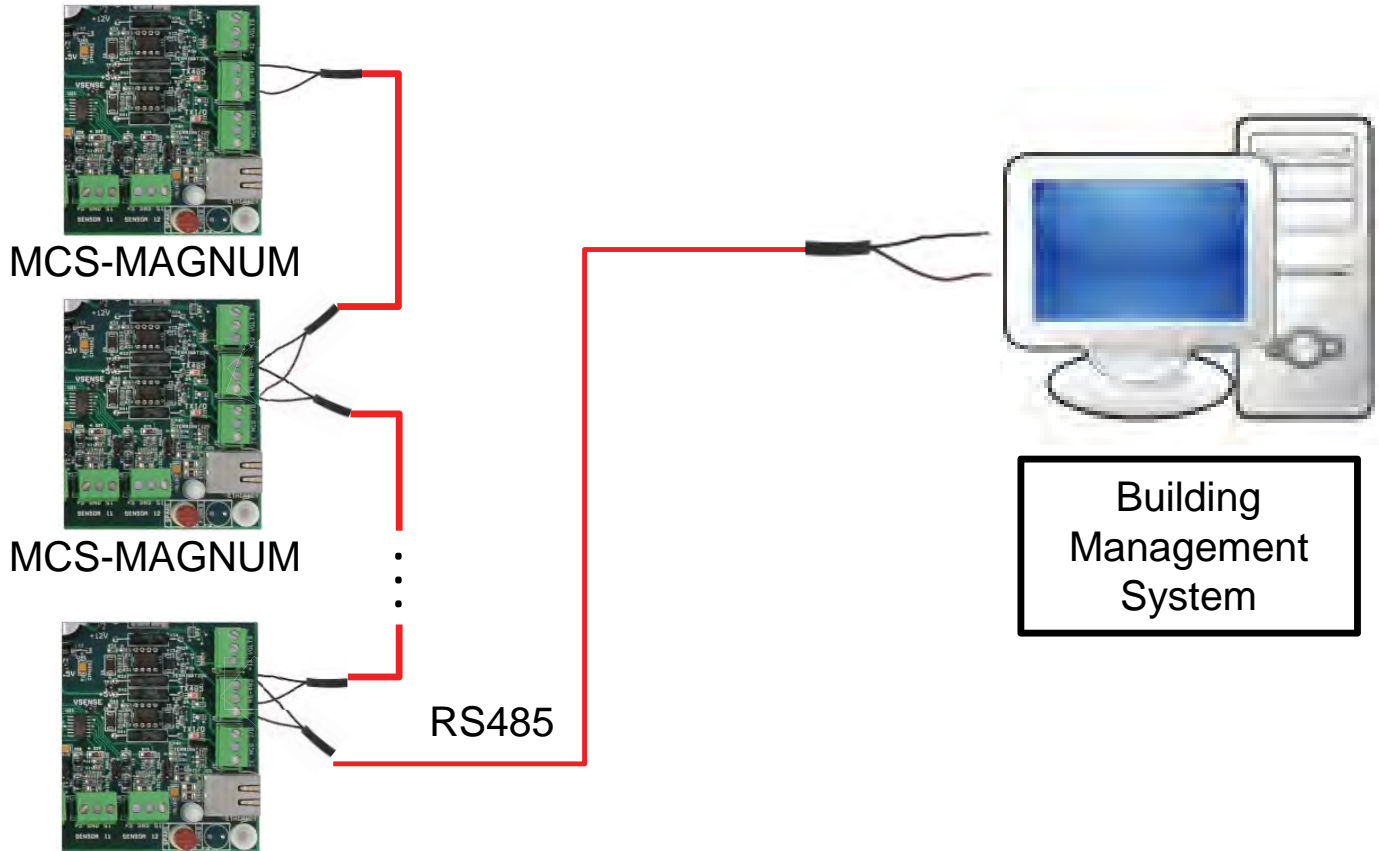

27.3. MCS-MAGNUM USING ETHERNET

- Using the Ethernet, the MCS-Magnum can be connected to:
- BMS (Bacnet IP or Modbus IP)
- MCS-Touch (MCS-Connect)
- PC (MCS-Connect)
- Internet access through router (which allows connection via MCS-Connect from anywhere)

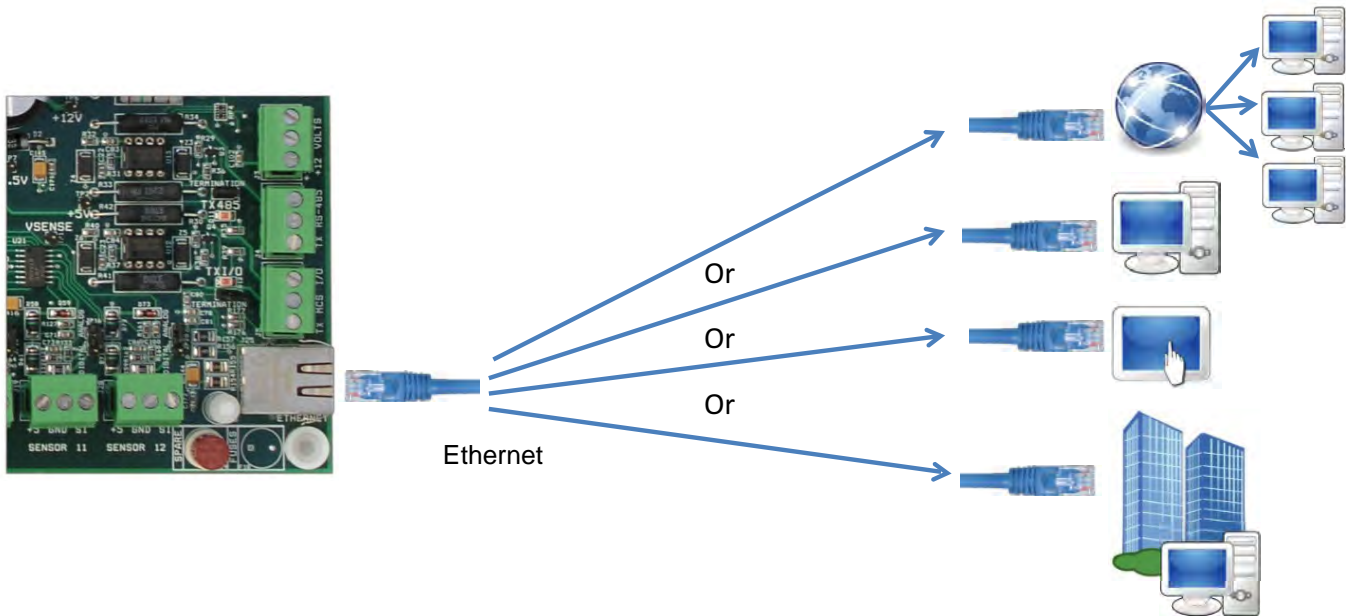

27.4. EXAMPLE NETWORK

27.4.1 Standalone MCS-Magnum

- MCS-Touch
- BMS (Johnson N2 or LonTalk or Bacnet MSTP)
- Internet Access

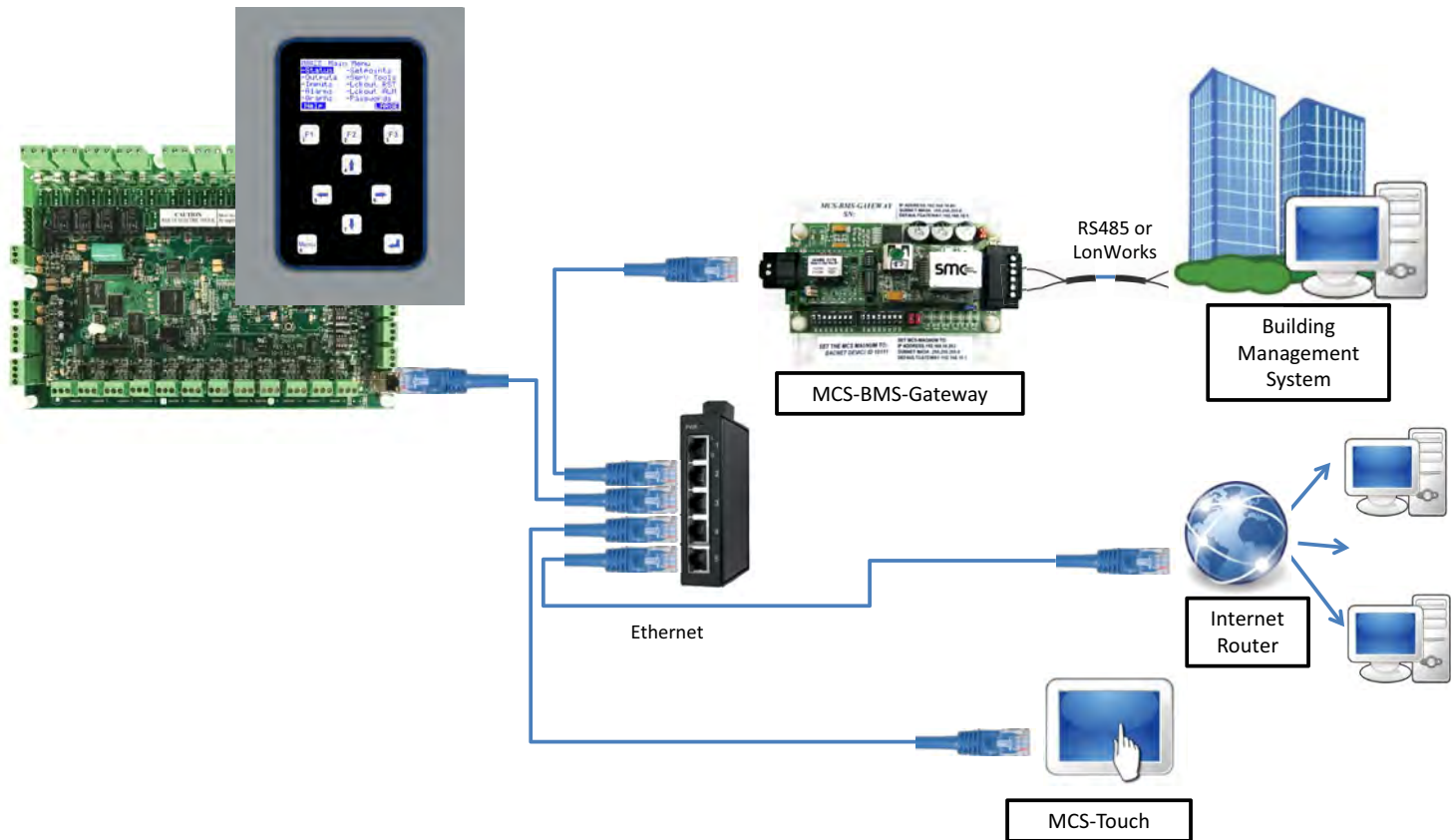

27.4.2 MULTIPLE MCS-MAGNUM Industrial Control Panels

- Internet Access
- BMS (Bacnet IP or Modbus IP)

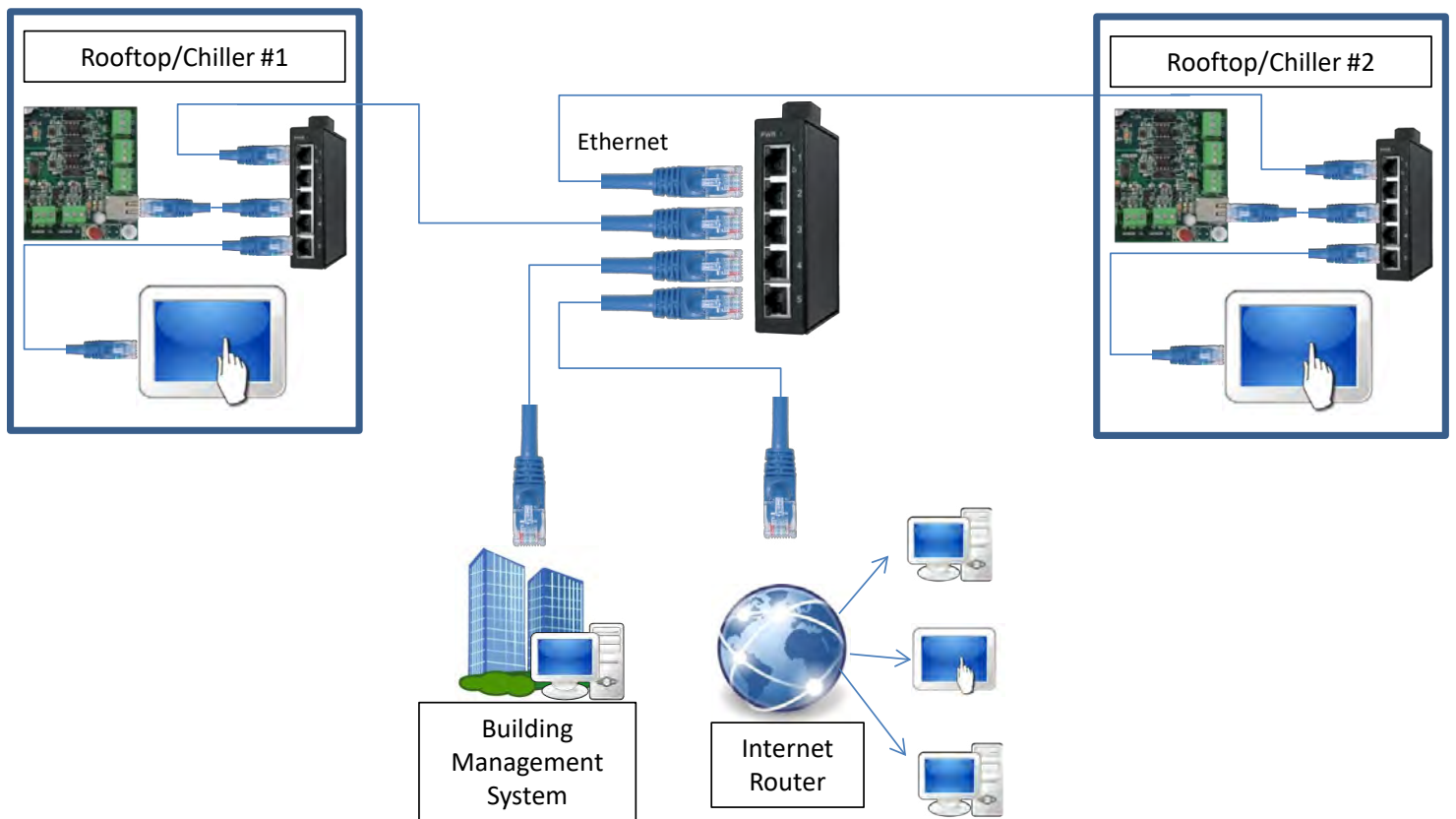

27.5. MULTIPLE MCS-MAGNUM BMS RS485 WIRING DIAGRAM

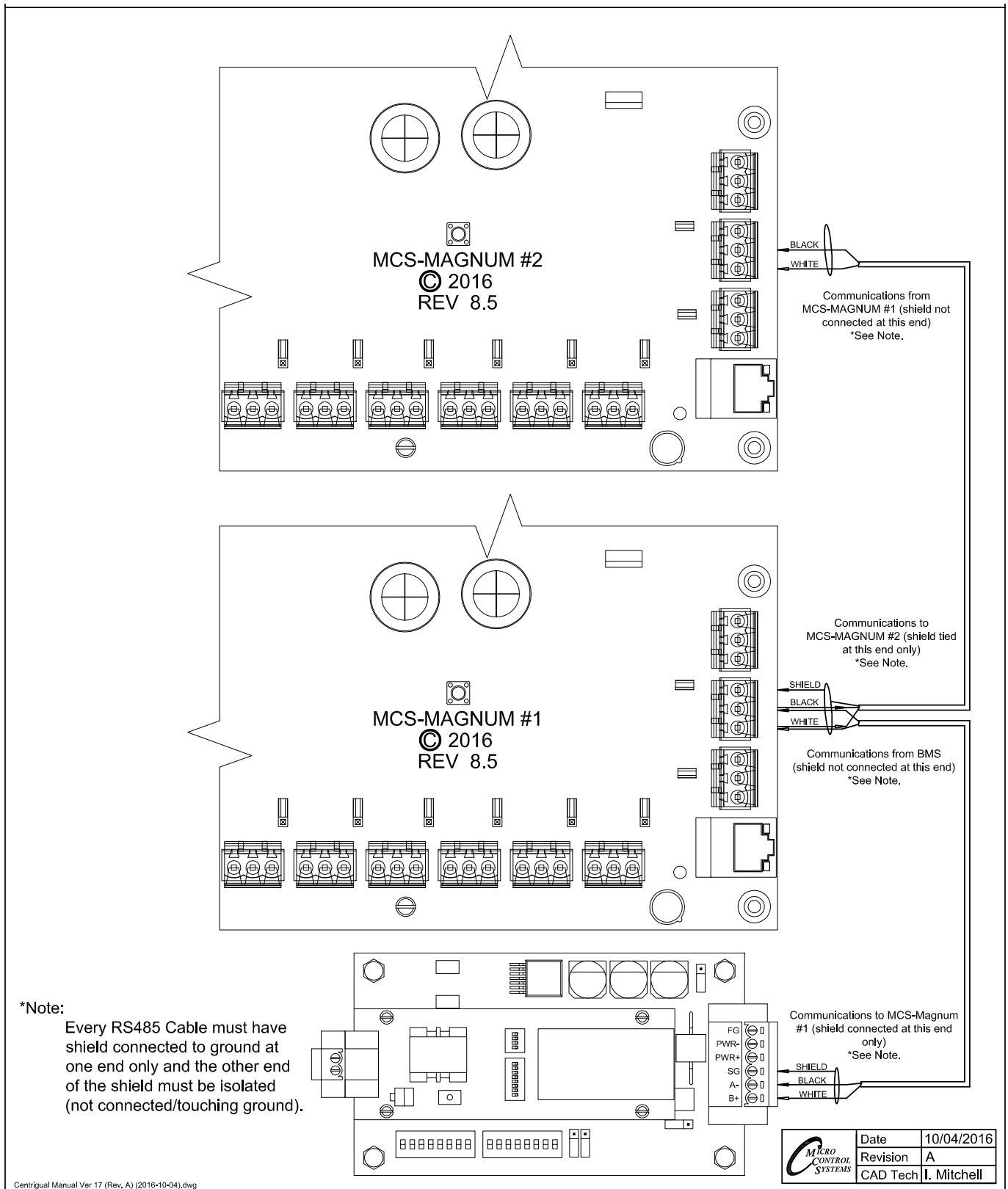

Chapter - 28. MODBUS RTU

Modbus RTU is supported directly by the MCS-Magnum using the RS485 port.

Please note this is the same port you plug into the RS232, so if using Modbus RTU you cannot plug you laptop into RS232 port on the older keypad.

Please note the RS485 follows industry standard, two wire twisted pair in shielded cable.

28.1. Setup the Modbus from MCS-Config's Magnum Setup Screen(see below):

The screenshot displays the 'MAGNUM Setup Screen' with the following configuration details:

- System Navigation:** System, Setup, ROs, SIs, AOs, MAG RTU, Circuit Base, Circuit SI, Setpoints, Auth, Schedule, BM.
- Display Units:** Deg F / PSI
- Default LCD Display:** UNIT STATUS
- Default Display Point:** (Empty)
- Max Lockout Resets per Day:** 6
- Auth Level Bypass:** Supervisor Level
- Lockout Reset SI:** Not Used
- History Sample Rate (Seconds):** 90
- Activate Keypad Cursor Quick Move Feature?:** Yes No
- Generate Alarm for Network Time Synchronization:** Yes No
- Generate Alarm When Configuration is Updated:** Yes No
- Display Alarm Character(a) On Keypad LCD Screen:** Yes No
- Total Number of RO's:** 30
- Total Number of AO's:** 17
- Total Number of SI's:** 81
- Number of RO Boards:** 1
- Number of SI16 boards:** 3
- Type of I/O Boards:** RO-8 & SI-16 & MCS I/O RO-10 & SI-16-A04
- MCS-Thermostat:** Yes No
- Factory Startup:**
 - Enable This Feature?:** Yes No
 - Feature Is Active? (Password Entered):** Yes No
- Run Hour Lockout:**
 - Enable This Feature?:** Yes No
 - Feature Is Active? (Password Entered):** Yes No
- Daylight Savings Time:**
 - Daylight Savings Time Active:** Yes No
 - Daylight Savings Time DOW:** Sunday
 - Daylight Savings Time Hour:** 2
 - Spring Forward Month:** March
 - Spring Forward Begin Date:** 8
 - Spring Forward End Date:** 14
 - Fall Back Month:** November
 - Fall Back Begin Date:** 1
 - Fall Back End Date:** 7
 - Reset to U.S.A Daylight Savings:** (Button)
- RS485 Communication:**
 - RTU Protocol Address:** 1
 - Protocol Type:** MODBUS RTU
 - Baud Rate:** 9600
 - Slave Address:** 1
 - Disable Alarm Grid Pop-Up In MCS-Connect?:** Yes No
- Ethernet Communication:**
 - Static IP:** **Dynamic IP:**
 - IP Address:** 192.168.10.253
 - Subnet Mask:** 255.255.255.0
 - Default Gateway:** 192.168.10.1
 - MCS IP Port:** 5001
 - BACnet Device ID:** 181 02
 - BACnet Port:** 47 808
 - Extended BACnet Device ID:** (Empty)
 - Hardcoded Port Numbers:** Modbus Port = 502, Website Port = 80
 - Used In 9.11 to Present MAG-Softv:** (Empty)
 - BACnet MV Values Start At:** Zero One
- System Graphic Information:**
 - Name of Graphic .html file:** C://MCS/Graphics/ RL134/SystemOverview.html

28.2. From MCS-Connect's Service Window RS485 tab (see below):

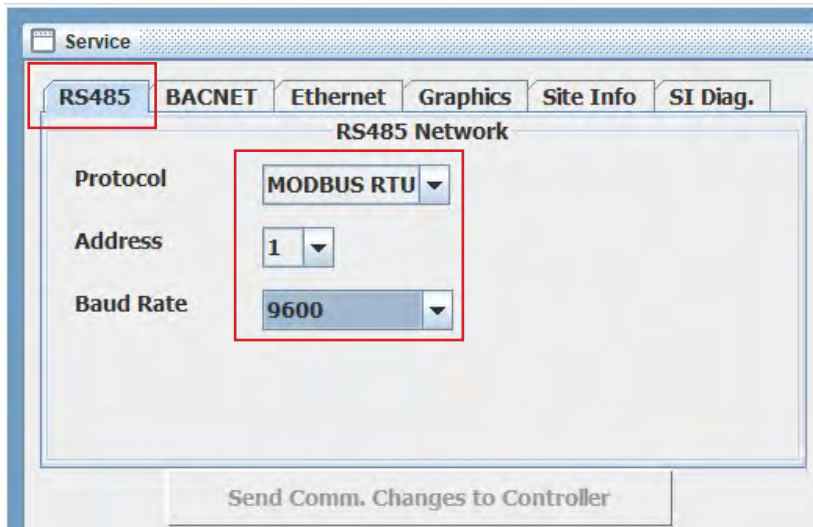

28.3. From MCS-Magnum LCD/Keypad(see below):

Service Tools (RS485 Network)



28.4. In MCS-CONFIG you can see & print a list of the Modbus Registers (see below):

MCS-MAGNUM		BACNET ID		MODBUS IP & RTU	
PT	Name	Object ID	Name	Register	# Assumed Dec
M-1	ChiWtr In	AI:1	ChiWtr In	30001	1
M-2	ChiWtrOut	AI:2	ChiWtrOut	30002	1
M-3	SUCT PSI 1	AI:3	SUCT PSI 1	30003	1
M-4	DISC PSI 1	AI:4	DISC PSI 1	30004	1
M-5	OIL PSI 1	AI:5	OIL PSI 1	30005	1
M-6	AMPS 1	AI:6	AMPS 1	30006	1
M-7	SUCT TMP 1	AI:7	SUCT TMP 1	30007	1
M-8	DISC TMP 1	AI:8	DISC TMP 1	30008	1
M-9	MTR TMP 1	AI:9	MTR TMP 1	30009	1
M10	MTR FLT 1	AI:10	MTR FLT 1	30010	0
M11	OIL LVL 1	AI:11	OIL LVL 1	30011	0
M12	DISABLE 1	AI:12	DISABLE 1	30012	0
M13	CHW FLOW	AI:13	CHW FLOW	30013	0
M14	PHASELOSS	AI:14	PHASELOSS	30014	0
M15	RUN/STOP	AI:15	RUN/STOP	30015	0

The MCS-Magnum Modbus RTU setting allow you to specify the Modbus Slave address, Modbus Baud rate (4800, 9600, 19200, 38400, 57600 are supported).

The number data bit is 8, stop bit is 1 and parity is none (these parameter are not adjustable).

The sensors inputs are 16 bit signed values. (Read input Registers, Function code = 4)

- The analog sensor inputs values typically have 1 assumed decimal place, meaning a value of 12.3 will be transmitted as value 123. The # of decimal point depending on the sensor type define in the MCS-MAGNUM CONFIG. Most sensor types are 1 decimal place.

But take care there are a few 2 decimal and a few zero decimal place types.

The BMS point list has a column which indicates how many assumed decimal are contained in the value.

- The digital sensor inputs values will be 0 or 1, 0 = off and 1 = on.

The analog outputs are 16 bit signed values. (Read Input Registers, Function code = 4)

- The analog output have 1 assumed decimal place, meaning a value of 12.3 will be transmitted as value 123.

The relay outputs are 16 bit packed values. (Read Coil Status , Function code = 1)

- Each bit within the 16 bits can contains a relay output. A bit value of 0 = relay off, 1 = relay on.

The number of packed bit depends on the requesting Modbus message.

If only one coil is asked for, then only bit 0 will contains a relay status value and bit 1 thru 7 are do not care.

If two relays are asked for, then bit 0 and bit 1 will contains values and bit 2 thru 7 are do not care.

The setpoints are 16 bit signed values. (Read Holding Registers, Function code = 3)

- The setpoints values typically have 1 assumed decimal place, meaning a value of 12.3 will be transmitted as value 123.

The # of decimal point depending on the setpoint type defined in the MCS-MAGNUM CONFIG.

Chapter - 29. Magnum Alarms and Safeties

There are three types of alarms that are generated by the Magnum control logic:

- Information only alarms,
- Magnum system alarms and
- Chiller Setpoint safety alarms.

All alarms have the same format. The alarm is identified and is date/time stamped. Alarms can be viewed from the Magnum keypad by selecting the 'Alarms' from the main menu, or through MCS-Connect.

29.1. Information Only Alarms

29.1.1 System Generated Alarms

The following alarms are generated to provide information; they will not cause a change in the control algorithm such as a lock out condition or a Relay Output being forced off.

- POWER FAILED – Generated when power to the Magnum was lost.
- POWER RETURNED – Generated when power to the Magnum returned.
- HW DATE INVALID – The date contained/read from the hardware real time clock chip is not valid. Check battery voltage, it should be > 2.0 vdc.
- HW TIME INVALID – The time contained/read from the hardware real time clock chip is not valid. Check battery voltage, it should be > 2.0 vdc.
- SW DATE INVALID – The date contained/read from the software clock is not valid.
- SW TIME INVALID The time contained/read from the software clock is not valid.
- RAM INTEGRITY – the data contained in the battery-backed up RAM memory may be corrupted. This does not stop the Magnum from running. It means the historical data may be incorrect (run times, cycles, min/max values, and trend/graph data).
- WATCHDOG RESET – The Magnum has reset itself because of improper operator of the Magnum board. Please consult the manufacturer if this alarm has occurred.
- LOST A/D CONVTR – The Magnum microprocessor has lost communications to the Analog to Digital converter chip (chip that converts sensor voltages to a digital number). Check for a shorted sensor that may cause
- LOST DISPLAY – Generated when communication to the Keypad/Display is lost.
- CF INIT ERROR – The Compact Flash card that was installed cannot be initialized and therefore cannot be used. Replace the Compact Flash card with one that works.
- BATTERY FAILED – Generated when Magnum is not getting power from the Battery.

29.1.2 User Initiated Alarms

The following alarms indicate that an individual took action: (Most require proper authorization)

- LOCKOUT RESET – Generated when a user resets a compressor other unit from a locked condition.
- COMPUTER RESET – Generated when the manual reset button on the Magnum is pressed.
- ALARMS CLEARED – Generated when a user clears the alarm history.
- STPT CHANGED – Generated when a user makes a change to a Setpoint; the number of the Setpoint will also be displayed with the alarm.
- RO TO (Selected Condition) – Generated when a user manually changes the condition of a Relay Output (either AUTO, MANON, or MANOFF).
- AO TO (Selected Condition) – Generated when a user changes the condition of an Analog Output (either AUTO or MANUAL. If MANUAL, then a dialog box will appear to input the number value).

- SI TO (Selected Condition) – Generated when a user changes the condition of a Sensor Input (If a digital input, then either AUTO, MANON, or MANOFF. If an analog input, then either AUTO or MANUAL. If MANUAL, then a dialog box will appear to input the number value).
- POINT INFO CLEAR – Generated when a user clears all point information (run times, cycles, min/max values, etc.).
- CLOCK SET – Generated when a user makes a change to the Magnum real time clock.
- CFG DOWNLOADED – Generated when a user uploads a new configuration file into the Magnum.
- ETHERNET CHANGE – Generated when a user makes a change to the Ethernet settings through the Keypad/Display.
- RS485 CHANGED – Generated when a user makes changes to the RS485 address through the Keypad/Display.
- CF CARD INSERTED – Generated when a user inserts a Compact Flash memory card into the Magnum.
- CF CARD REMOVED – Generated when a user removes a Compact Flash memory card from the Magnum.

29.1.3 Automatic Alarms

The following alarms indicate an action that the Magnum made automatically:

- ROTATED LEAD – Generated when the Magnum automatically rotates the Lead Compressor.
- DAYLIGHT SAVINGS – Generated when the Magnum automatically changes the real time clock to adjust for Daylight Savings Time.

29.2. Magnum System Alarms

29.2.1 Configuration Alarms

These alarms indicate a problem with the configuration file in the system. The system is not operational and a new configuration must be transmitted to the unit through MCS-Connect.

- INVALID CONFIG – Checksums are incorrect.
- INVALID CFG VER – The version number of the configuration is invalid.
- INVALID CFG TYPE – The configuration type does not match the software type.

29.2.2 MCS Local Network Alarms

These alarms indicate problems with the MCS local network:

- LOST SI COMM #_ / LOST RO COMM #_ –Generated when communications to a Sensor Input or Relay Output board is lost. The number of the board will be displayed with the alarm. The system can be accessed but will be in a NO RUN- I/O LOST state.
- MCS-STAT OFFLINE – The Magnum has lost communications to the MCS-STAT.
- LOST IO SHUTDOWN – Generated when Magnum is running and there are no communications to one or more of the I/O boards. The system can be accessed but will be in a NO RUN- I/O LOST state.
- LOST I/O RESTART – Generated when the Magnum does an automatic reset once I/O communications are restored.

29.2.3 Key Sensors Alarms

These alarms indicate a problem with a key sensor, it is either shorted or open. The alarm will contain ALARM followed by the 10-character name of the sensor. The following sensors related to the entire system are tested:

- Leaving temperature: If failed, then Lock Out the system.
- Returning temperature: If failed, then alarm only no Lock Out.

- Ambient temperature: If failed, then alarm only no Lock Out.

The following compressor sensors are tested. If they fail, then that compressor only is locked out:

- Suction pressure and temperature
- Discharge pressure and temperature
- Oil pressure and temperature
- Motor temperature (if an analog input)

29.2.4 Emergency Stop Alarm

- EMERGENCY STOP – Generated when the emergency stop switch has been turned on. The system can be accessed but is in a Lock Out state.

29.3. Setpoint safety alarms

The Magnum algorithm incorporates a number of safety checks, based on Setpoints, preventing unsafe conditions that could potentially cause damage to the system. When a safety trips the circuit will be in a SAFETY TRIPPED state. The circuit will remain in this state for the time in the 'Safety Down Time (min)' cell and then move to the CMP ANTICYCLE or CMP IS OFF state where the compressor will be allowed to run again if required. If the same safety trip occurs again within the time in the 'Lockout Delay Hrs' cell since the first trip, the circuit will be set to CMP LOCKED OUT state, which requires a manual reset to restart the compressor. If the lockout delay time is set to zero, the Magnum will generate a lockout condition the first time that the safety occurs.

29.3.1 Sensor Inputs Used With Magnum Setpoint Safeties:

- Suction Pressure(Analog or Digital)
- Discharge Pressure (Analog or Digital)
- Oil Pressure (Analog or Digital)
- Oil Differential Pressure (Calculated value)
- Oil Temperature (Analog or Digital)
- Discharge Temperature (Analog or Digital)
- Motor Temperature (Analog or Digital)
- Motor Amps (Analog or Digital)
- Motor Fault (Analog or Digital)
- Liquid Temperature (Analog Only)
- Compress Proof (Digital Only)
- Flow Switch (Digital Only)

29.3.2 Setpoint safeties

For a safety trip to occur, both the Sensor Input and the associated Setpoint must be active. If a safety trips, the alarm name will consist of the Setpoint name plus additional identification such as point number, compressor number, or 30 second history leading up to the trip if applicable.

Note: Most safeties are checked only if the compressor is running, however if the safety is always checked it will be noted.

The following is a list of safeties that are incorporated in the standard chiller algorithm control. These safeties are checked every second. For a system with multiple circuits, each one is tested individually. If a safety trip occurs, only that respective compressor will be affected, the others will continue to function normally.

Freeze Protection (SAFETY IS ALWAYS CHECKED)

If the leaving temperature drops below the Setpoint value then the entire system will Lock Out and a FREEZE alarm will be generated. There is also an option to have one freeze protect for each individual circuit. Refer to Setpoint #111.

No Flow Protection

If a flow switch is used, then the entire system will be Locked Out if Setpoint #105 is active. If the Setpoint is

inactive, the Magnum will determine if there is a second pump, if so it will be started. Else, the system will shut down and automatically restart when the flow switch is on, indicating flow has returned. There is also an option to have a flow switch for each individual circuit. Refer to Setpoint #105.

Phase Loss Protection

Phase loss, as indicated by the phase loss monitor, will result in the entire system being Locked Off and a phase loss alarm will be generated. If Setpoint #166 is inactive the Magnum will wait for 2 seconds before the Lock Out occurs. The alarm will be PHASE LOSS and no restart will be attempted. If Setpoint #166 is active, the name of the Setpoint will be in the message. Refer to Setpoint #166.

Low Differential Oil Pressure

This safety is designed to meet the compressor manufacturer requirements on oil pressure. For the first 5 seconds following a compressor start (60 seconds if Hitachi screw compressor) this safety is NOT checked. For the next 30 seconds, if the oil differential pressure drops below $\frac{1}{2}$ of the value of the Setpoint or the digital input turns ON for the time specified in the 'Time (sec)' field of that Setpoint, then the circuit will be Locked Out and a LOW OIL alarm generated. After this time period, if the oil differential pressure drops below the value of the Setpoint and it remains there for the time specified in the 'Time (sec)' field, then the compressor will be Locked Out and a low oil alarm generated. This safety is checked for when the compressor is on and not in a Pump Down state. Refer to Setpoint #91.

Low Suction Pressure

If the suction pressure drops below the value of the Setpoint or the digital input turns ON for the time specified in the 'Time (sec)' field, the compressor will be locked out and a LOW SUCTION alarm generated. This safety is bypassed when the compressor is in a Pump Down state. This safety can also be used as a freeze protection based upon the suction pressure. When this safety trip occurs, all compressors in the same suction group will react in the same manner. Refer to Setpoint #77.

Unsafe Suction Pressure

This safety is similar to the low suction pressure safety, except it is often set up with a lower value and a shorter safety time. If the suction pressure drops below the value of the Setpoint or the digital input turns ON for the time specified in the 'Time (sec)' field of that Setpoint, then the circuit will be Locked Out and a UNSAFE SUCTION alarm generated. This safety will always cause a Lock Out on the first trip, requiring a manual reset. This safety is bypassed when the compressor is in a Pump Down state. When this safety trip occurs, all compressors in the same suction group will react the same. Refer to Setpoint #80.

High Discharge Pressure (SAFETY IS ALWAYS CHECKED)

If the discharge pressure rises above the value of the Setpoint or the digital input turns ON for the time specified in the 'Time (sec)' field of that Setpoint, then the circuit will be locked out and a HIGH DISCHARGE alarm generated. Refer to Setpoint #81.

Low Discharge Pressure

If the discharge pressure drops below the value of the Setpoint for the time specified in the 'Time (sec)' field, the compressor will be Locked Out and a LOW DISCHARGE alarm generated. Refer to Setpoint #85.

High Discharge Temperature (SAFETY IS ALWAYS CHECKED)

If the discharge temperature analog input rises above the value of the Setpoint or the digital input turns ON for the time specified in the 'Time (sec)' field, the compressor will be Locked Out and a HIGH TEMPERATURE alarm generated. Refer to Setpoint #87.

High Motor Temperature or Motor Fault (SAFETY IS ALWAYS CHECKED)

If the high motor temperature input rises above the value of the Setpoint or the digital input turns ON for the time specified in the 'Time (sec)' field, the circuit will be Locked Out and a HIGH MOTOR TEMPERATURE or MOTOR FAULT alarm generated. Refer to Setpoint #95.

High Oil Temperature

If the oil temperature rises above the value of the Setpoint or the digital input turns ON for the time specified in the Time (sec)' field, the compressor will be locked out and a HIGH OIL TEMPERATURE alarm generated. Refer to section #94.

High Motor Amperage

If the amperage analog input rises above the value of the compressor's respective FLA Setpoint #171 – 190 times the value of Setpoint #75 or the digital input turns ON for the time specified in the Time (sec)' field, then

the circuit will be Locked Out and a HIGH MOTOR AMP alarm generated. Refer to Setpoint #75.

Low Motor Amperage

If the amperage analog input drops below the value of the compressor's respective FLA Setpoint #171 – 190 times the value of Setpoint #76 or the digital input turns ON for the time specified in the Time (sec)' field, then the circuit will be Locked Out and a LOW MOTOR AMP alarm will be generated. Refer to Setpoint #76.

Voltage Sensor (08.00-R)

Up to three sensors that measure voltage input can be specified. If used, a safety condition based upon Setpoint #195 LOW VOLTAGE and Setpoint #196 HI VOLTAGE will be checked. If a safety trip occurs the unit will be placed in a safety hold state.

Motor Amps (08.00-R)

Up to three sensors that measure amperage input can be specified per circuit. If used a safety condition based upon Setpoints #75 HI AMPS and #76 LO AMPS, plus the associated Full Load Amps (FLA) for that circuit will be checked. If a safety trip occurs, that circuit will be placed in a safety hold state.

Add an Amp Imbalance Safety Test to the existing Amp Safeties.(17.35)

All three Motor Amps (A, B, & C) sensors must be indicated and **setpoint #241** must be active and be setup as a normal safety and contain:

- Type: Either Lockout or Alarm
- Select Value: HUMD or %
- Value: Maximum percentage of deviation
- Time: Normal safety
- Lockout Delay: Normal safety
- Safety Down Time: Normal safety

This safety will be run every second when the compressor is on and the split winding relay is on if one exists (same requirement as other amp safeties).

The three amp sensor values will be totaled and averaged. If any of the amp sensors are more than the percentage of the value of **setpoint #241** difference from the average for more than the time specified in the time cell of **setpoint #241** the compressor will be tripped and the error message will be the name of **setpoint #241** plus the circuit number. The normal 2 trip logic will apply if the set point is a lockout type.

No Compressor Proof

If a compressor is called to be on and the compressor proof digital input is OFF, a NO COMP PROOF alarm will be generated. Refer to Setpoint #96.

High Oil Seal Temperature (Screw Compressors only)

If the oil seal temperature analog input rises above the value of the Setpoint for the time specified in the Time (sec)' field, then the circuit will be Locked Out and a HIGH OIL SEAL alarm generated. This safety is bypassed when the compressor is in a Pump Down state. Refer to Setpoint #93.

Dirty Oil Filter (Fixed Step Compressors only)

If the difference between the discharge pressures minus the oil pressure is above the value of the Setpoint for the time specified in the Time (sec)' field, a DIRTY OIL FILTER alarm will generate. Refer to Setpoint #97.

Low Discharge Superheat

If the discharge superheat is below the value in Setpoint for the time specified in the Time (sec)' field, then the circuit will be Locked Out and a LOW DISCHARGE SUPERHEAT alarm will be generated. Refer to Setpoint #84.

29.4. TurboCor Compressor Alarms

Inverter Temperature Fault (Hex code =0x0001)

The measured Inverter Temperature has exceeded either the Alarm or Fault limit, probably due to insufficient inverter cooling.

Discharge Temperature Fault (Hex code =0x0002)

The measured Discharge Temperature has exceeded either the Alarm or Fault limit, probably due to insufficient charge (not enough gas).

Suction Pressure Fault (Hex code =0x0004)

The measured Suction Pressure has exceeded either the Alarm or Fault limit, probably due to insufficient charge or insufficient system load.

Discharge Pressure Fault (Hex code =0x0008)

The measured Discharge Pressure has exceeded either the Alarm or Fault limit, probably due to a faulty condenser. *Instantaneous lock out at fault level.

3 Phase Over Current Fault (Hex code =0x0010)

The estimated Mains Supply voltage has exceeded either the Alarm or Fault limit, probably due to excessive system load on mains supply (usually the compressor is pumping liquid). *Instantaneous lock out at fault level.

Cavity Temperature Fault (Hex code =0x0020)

The measured Cavity Temperature has exceeded either the Alarm or Fault limit, probably due to insufficient motor cooling (shaft cavity).

Leaving Fluid Temperature Fault (Hex code =0x0040)

The measured Air / Water Temperature has exceeded either the Alarm or Fault limit, probably due to insufficient air / water flow.

Pressure Ratio Fault (Hex code =0x0080)

The measured Compression Ratio of Discharge and Suction has exceeded either the Alarm or Fault limit, probably due to faulty condenser or insufficient load on the evaporator.

Generic Bearing/Motor/Compressor Fault (Hex code =0x0100)

If the Motor Fault Word, 40106, or the Bearing Fault Word, 40098, is different from 0, then the Generic Compressor Fault is triggered.

Sensor Fault (Hex code =0x0200)

If the following measured degrees Celsius are surpassed, a Sensor Fault is triggered. The pressure values are in kPa:

40105 Inverter Temperature >100 or < 0

40037 Cavity Temperature >100 or < -20

40034 Suction Temperature >100 or < -30

40036 Discharge Temperature >110 or < -30

40046 Leaving Water Temperature >100 or < -20

40031 Suction Pressure >1200 or < -30

40033 Discharge Pressure >3500 or < -30

SCR Temperature Fault (Hex code =0x0400)

The measured SCR Temperature has exceeded either the Alarm or Fault limit. Probably due to insufficient SCR plate cooling.

Lock Out Fault (Hex code =0x0800)

If any (or a combination of) the Faults listed below occurs more than 3 times (reg. 40262) within 30 minutes (reg. 40263), a "Lock Out Fault" occurs:

- Inverter Temperature trip
- SCR Temperature trip
- Motor Current High trip
- Inverter Error Signal Active trip
- Rotor May Be Locked trip
- Motor Back emf trip

*Instantaneous lock outs:

- Discharge Pressure
- 3 Phase Over-Current

Winding Temperature Fault (Hex code =0x1000)

The measured motor winding temperature has exceeded 155°C.

Superheat Fault (Hex code =0x2000)

The Fault limit is based on the suction pressure and temperature values. There is no time delay on this fault or alarm. The difference between the fault limit and alarm limit is the dead band for the control.

Reserved (Hex code =0x4000)

Reserved (Hex code =0x8000)

Chapter - 30. Troubleshooting Quick Reference

(A more detailed troubleshooting guide is available on our website: www.MCScontrols.com)
Magnum Simplified Description & Troubleshooting Rev 2.5

PROBLEM	POTENTIAL SOLUTION
No Sensor + 5 vdc or sensor +5 vdc output is less than 4.90 vdc.	Indicates a possible shorted input sensor Remove all sensor terminal blocks. Wait about 30 to 60 seconds. If + 5 vdc returns, replace one sensor wire at a time until the + 5 vdc is lost again. This will be the shorted sensor.
A Sensor Input reads -99.9	This indicates an open Sensor Input signal or 5 VDC problem. Check sensor wiring for missing wire or poor connection. Check for faulty sensor. Check + 5 vdc on Sensor Input to ground. If less than 5 VDC is on the sensor 5 VDC terminal block, the problem is with probably a shorted sensor. (A poly fuse protects the board) Remove all Sensor Input terminals. Wait about 1 minute or until 5 VDC restored at Sensor Input. Connect terminals 1 at time until short reappears and fix bad sensor.
A Sensor Input reads +999.9	This indicates a shorted Sensor Input signal. Check sensor wiring for +5VDC shorted to signal etc. Check for faulty sensor.
A pressure sensor is reading more than 1 psi off (The temperature and humidity sensors do not require calibration.)	This indicates the transducer Sensor Input needs to be calibrated through the off-set capability in the software. (Transducers by design need to be calibrated based on construction and altitude.) You must use the MCS-Connect with a valid Authorization code to change sensor offsets See MCS-Connect Interactive section for instructions. (Change SI Status, Manual Value and / or offset.)
Invalid reading on one Sensor Input.	This indicates an input problem with 1 sensor. Verify jumper settings correct for that SI.
Lost I/O	Indicates communications problem. Verify RS485 LED blinking. Verify termination jumper J6 only on at Magnum and last I/O. Verify Magnum and I/O address's set correctly. Verify wiring from Magnum to each I/O correct. Check fuses/120 VAC on I/O units
Lost I/O - Shutdown Alarm	Sensor could be failing giving a Loss I/O shutdown alarm: Possible cause of this alarm is a failing sensor input (SI) where the +5vdc has been reduced to <3vdc. Check the +5 to ground on each sensor board. When you have identified the SI board with the problem remove each SI cable until you get +5vdc back. Replace the failing sensor.

PROBLEM	POTENTIAL SOLUTION
MCS-Connect cannot make changes	<p>This indicates you are not at a proper authorization level. Follow steps below for proper authorization From either the SITE INFO or STATUS screen in MCS-Connect, click the 'View Only' button at the top of the screen, or click on the 'Passwords' menu option on the lower right of your Keypad/LCD display. Follow prompts and enter a valid 4-digit authorization number. The authorization level is displayed at the top of the display and is reflected by the color of the Authorization button.</p> <p>Red = View Only Light Blue = User level Purple = Service level Dark Blue = Supervisor level Green = Factory level Green = Admin</p>
Invalid authorization	<p>This indicates an invalid authorization number. Follow steps below for proper authorization Press Service Diagnostics key until the authorization option appears Press the Enter key From the "Display Status" press keys corresponding to your authorization number. Press Enter</p>
SI from AMPS board 10 A low.	<p>This indicates a problem with this SI only. Jumper setting on this SI in wrong position. Incorrect sensor type used.</p>
INVALID CONFIG VER	<p>Indicates layout of CFG wrong. CFG layout for different version than software</p>
INVALID CONFIG TYPE	<p>Indicates CFG incompatible with software.</p>
INVALID CONFIG CHECKSUM	<p>Indicates Checksum invalid Reload a valid CFG</p>
Sensor input believed invalid (Under Sensor Diagnostic Sub Menu)	<p>Verify Berg jumpers using Quick Reference Sheets Check board version number Check wiring of sensor</p>
Communications to MCS-485-GATEWAY from MCS-Connect not working.	<p>Verify red LED on the gate way is blinking. This indicates that MCS-Connect is talking to the gateway. Verify that the two wire shielded cable is properly wired from the RS-485 connector to the gateway. Verify red LED (Located just to the left of the RS-485 connector on the Magnum board is blinking. This indicates that the Magnum is responding to the gateway. If both of these LED are blinking, check the address of the Magnum and any other Magnums that are on the network. Each must have a unique address. This address can be changed from the Magnum. Proper authorization is required. Enter the UNIT INFORMATION screen by pressing the SERVICE DIAGNOSTIC key and scrolling to this item. Press the enter key and scroll to the NETWORK ADDRESS screen. Change address if needed. Verify + 12 vdc to MCS-485-GATEWAY</p>
INVALID CONFIG	<p>Indicates Checksum invalid Either set to factory defaults on reset settings.</p>

Chapter - 31. Magnum Centrifugal Setpoints

Setpoint Information Screen

#	Name	Value	Min	Max	Adjust Value	Time (SEC)	Max Time Allowed (SEC)	Lockout Delay (HRS)	Safety Down Time(MIN)	Active or Non-Active	Select Value: # decimals & print char	Level Of Auth. To Display	Type of Setpoint	Comments	SEC to Ignore Safety	Window to Ext. Safety Time(SEC)	Safety Time Extension (SEC)
---	------	-------	-----	-----	--------------	------------	------------------------	---------------------	-----------------------	----------------------	---------------------------------------	---------------------------	------------------	----------	----------------------	---------------------------------	-----------------------------

(Number)–From 1 to 255 (maximum number of Setpoints supported). Only active Setpoints will be displayed in MCS-Connect and on the keypad display.

Name–The Setpoint’s name consists of up to 12 characters. The name is displayed following the number on the LCD display. The Setpoint name can be changed to make it more meaningful to the current application, however the function of the Setpoint will remain the same.

Value–The value or target of the Setpoint. With proper authorization this value can be changed, within limits that have been established in MCS-Config.

Min–The minimum value that can be set. This field is not displayed and cannot be changed in MCS-Connect or in the keypad display.

Max–The maximum value that can be set. This field is not displayed and cannot be changed in MCS-Connect or in the keypad display.

Adjust Value–The interval that the value field can be changed by. This field is not displayed and cannot be changed in MCS-Connect or in the keypad display.

‘Time (sec)’ – this field has two purposes:

1) In either a LOCKOUT or ALARM type; this is the length of time the Setpoint must be true before it will trip. This time is always in seconds and it is displayed on the keypad display and MCS-Connect if the Setpoint is either a LOCKOUT or ALARM type. This field can be changed in MCS-Connect and through the keypad.

2) In a non-safety type Setpoint this field can be used as an extra timer. This will be specified in the Setpoint definition if it is used.

Lockout Delay Hrs. – If a second safety occurs within this time, the unit or compressor will be locked out. This field is not displayed and cannot be changed through MCS-Connect or in the keypad display.

Safety Down Time (min.) – After the first safety occurs the Magnum will wait this number of minutes before the unit or associated compressor is allowed to run again.

Active or Non-Active – Only active Setpoints will be displayed in MCS-Connect or on the keypad display, but only if the needed authorization level has been achieved.

Select Value: # decimals and print char – This indicates the number of decimal places and the unit character that accompanies the value displayed. The number of decimal places is crucial when the Value, Minimum, and Maximum data is entered in MCS-Config.

Level of Auth. To Display – This column indicates what authorization level a user must have in order to view the Setpoint from MCS-Connect or the keypad display.

Comments – This column allows the user to add comments about the function of the Setpoint.

BMS Writeable (Click Here to Disable All) – The Magnum software will enable communications with an outside source, building management system (BMS), to modify the value of a set point. Object is to provide maximum flexibility and capability with an BMS.

31.1. Setpoint Types

There are six different types of Setpoints. The Magnum software determines if a Setpoint contains a target value or is a safety. If it is a safety then its type determines what action the Magnum will take when the safety occurs (either locking out the unit or generating an alarm only).

31.1.1 SETPOINT

This type of Setpoint contains a target or provides information for some action. The time element in this type can be used for an additional counter if specified. This time is not displayed and cannot be changed through MCS-Connect or from the keypad display.

31.1.2 LOCKOUT

This type of Setpoint contains a safety value and the time that the safety must be violated before the safety will trip. Once a safety has tripped the Magnum will take the appropriate action, shutting down the entire package or an individual compressor depending on the purpose of the safety. The Magnum will then wait the Safety Down Time contained in that Setpoint before trying to return the normal. If successful, the system will continue to operate. If a second trip occurs on the same Setpoint within the Lock Out Delay Time that is contained in that Setpoint the system will move to a LOCKOUT state. If the lockout delay time is set to zero the lockout will occur on the first trip. This requires manual intervention to reset the system. With each safety trip, the Magnum will generate an alarm; refer to section 8 Magnum Alarms and Safeties.

Sec. to ignore safety - If this value is not zero, at compressor startup this safety will be ignored for the time in this field.

Window to extend Safety 'Time (sec)' – If this value is not zero, at compressor startup the normal Safety Time will be increased by the value in Safety Time Extension field for the time specified in this field.

Safety Time Extension (Sec) – This is the value that will be added to the Safety Time during the Window to extend Safety Time period.

31.1.3 ALARM

This type of Setpoint has two uses:

- 1) When it is used as a safety, it will be similar to the LOCKOUT Setpoint except it will never cause a lock out. The system will continue to try returning to normal operation after waiting the safety down time. An ALARM Setpoint type will never require manual intervention to reset the system.
- 2) When the Setpoint is being used as a second timer it will be available to change in a live unit. If the type is not changed to ALARM then the time field cannot be viewed or changed from a live unit.

Sec. to ignore safety - If this value is not zero, at compressor startup this safety will be ignored for the time in this field.

Window to extend Safety 'Time (sec)' – If this value is not zero, at compressor startup the normal Safety Time will be increased by the value in Safety Time Extension field for the time specified in this field.

Safety Time Extension (Sec) – This is the value that will be added to the Safety Time during the Window to extend Safety Time period.

31.1.4 Time

This type of Setpoint allows the 'Time (SEC)' value to be displayed and modified in a live unit.

31.1.5 Target

This type of set point is used to develop a target with a high and low zone values.

The decimal characteristics of these values are the same as the Value field

High Zone – The value of this cell is added to the Value cell to create the high zone value.

Low Zone – The value of this cell is subtracted from the Value cell to create the low zone value.

Night Setback – If system has an unoccupied mode, this value is used to modify the value of the 'Value' cell.

31.1.6 Delay

This type of set point is used to develop a target with a high and low zone values.

The decimal characteristics of these values are the same as the Value field

High Zone – The value of this cell is added to the Value cell to create the high zone value.

Low Zone – The value of this cell is subtracted from the Value cell to create the low zone value.

Night Setback – If system has an unoccupied mode, this value is used to modify the value of the 'Value' cell.

31.2. Window/Safety extension

31.2.1 Time and seconds to ignore for setpoints

- Seconds to ignore – This is the time in seconds to ignore the associated safety at compressor start up.

The window to extend safety time and safety time extension fields work together.

- Window to extend safety – This value in seconds is the time window when the compressor starts that the **safety time extension** is added to the safety **time(sec)** value.
- Safety time extension – This value is the time that is added to the **time(sec)** value during the **window to extend safety time(sec)** time.

Example – Unsafe suction setpoint has a 3 second safety trip. So if we add a 120 to our window to extend safety, we will then be telling the controller at startup we’re going to extend that 3 second safety trip for 120 seconds. This is where the Safety time extension comes into play. If we put a 6 in this field we’re telling the controller for the first 120 seconds at startup we’re extending the safety trip time to 9 seconds (3 second trip plus the 6 second extension). Once the 120 seconds expires we will then revert back to a 3 second trip time for the duration of the compressors run time till the next startup.

System Setup ROs SIs AOs MAG HVAC Circuit Base Circuit SI Setpoints Auth Schedule BMS Points Lookup Table																
Setpoint Information Screen																
Name	Value	Min	Max	Adjust Value	Time (SEC)	Max Time Allowed (SEC)	Lockout Delay (HRS)	Safety Down Time(MIN)	Active or Non-Active	Select Value: # decimals & print char	Level Of Auth. To Display	Type of Setpoint	Comments	SEC to Ignore Safety	Window to Ext. Safety Time(SEC)	Safety Time Extension (SEC)
LOW SUCTION	55	35	65	1	90	120	2	10	Active	...	PSI GAGE	View Only	Lockout	5	900	120
LO SUCT UNLD	2	2	6	1	0	0	0	0	Active	...	PSI GAGE	View Only	Setpoint	---	---	---
LO SUCT RELD	5	3	8	1	0	0	0	0	Active	...	PSI GAGE	View Only	Setpoint	---	---	---
UNSAFE SUCT	10	5	25	1	3	3	0	0	Active	...	PSI GAGE	View Only	Lockout	3	120	6

#	Name	Description
1	CTL TARGET	Control target. This value is used as the base to develop the Control Zone when the unit is in a cooling mode. Refer to setpoints #2 and #3. The control target is used with the control zone and rate of change of the controlling sensor to determine required action for the Magnum. The controlling sensor is usually one of the following: Leaving Temperature – Most common used as a target, fitting for most applications. Return Temperature – Used in sites with large air masses, ice rinks, common areas, etc. Suction Pressure – Used in continuously running process systems. If unoccupied state is used, when the system is in unoccupied mode the value in the Night Setback cell is added to the control target.
2	CTL ZONE +	Added to the CTL TARGET to create the upper limit of the control zone. 'Time (sec)' field: (Only accessed if CLLC control has been specified.) If this field is not zero then multiple the value by this amount to develop the upper limit of control zone.
	STAGE CUT OUT (Cut In/Out Control)	Offset used in calculating the cut out value. Subtracted from the stage cut in Setpoints #3 through #18
3	CTL ZONE - (Only CENT)	If this Setpoint is a target type and the Low Zone cell is >0 and <=5, use this value as the offset to the target to allow an unload adjustment of 3 else use 1.
	STAGE 1 CUT IN (Cut In/Out Control)	Stage 1 cut in, Setpoint value contains the voltage when this stage is turned on.
4	HGS TEMP ON IF USING OFFSETS, SETPOINT TYPE IS SET TO 'TIME'	This setpoint is used with compressors with a hot gas bypass solenoid to provide temperature control for turning on the solenoid. When this setpoint is active and the control temperature is less than the CTL TARGET plus the value in this setpoint and there is at least one compressor running in this suction group or the FLA % is within the slide percentage offset (refer to Time cell of this set point) of setpoint #31 "MIN SLIDE%", the hot gas bypass solenoid for the compressor will be turned on. 'Time (sec)' field: Contains the minimum slide percentage offset to enable the HGB. If non-zero, this value is added to setpoint #31 "MIN FLA%" to determine the range in which to enable the HGB. If zero, then the default value of 20 is added. For example , if this value is 10, then the HGB will enable when the compressors FLA% is within 10% of setpoint #31 "MIN FLA%". See setpoint #31 on how to setup as a target type to get the hardcoded 20% out of the way.
	STAGE 2 CUT IN (Cut In/Out Control)	Stage 2 cut in, Setpoint value contains the voltage when this stage is turned on.
5	HGS TEMP OFF IF USING OFFSETS, SETPOINT TYPE IS SET TO 'TIME'	This setpoint is used with compressors with a hot gas bypass solenoid to provide temperature control for turning off the solenoid. When this setpoint is active and the control temperature is greater than the CTL TARGET plus the value in this setpoint and there is at least one compressor running in this suction group or the FLA % is not within the slide percentage offset (refer to Time cell of this set point) of setpoint #31 "MIN SLIDE%", the hot gas bypass solenoid for the compressor will be turned off. 'Time (sec)' field: Contains the minimum slide percentage offset to disable the HGB. If non-zero, this value is added to setpoint #31 "MIN FLA%" to determine the range in which to disable the HGB. If zero, then the default value of 30 is added. For example, if this value is 15, then the HGB will disable when the compressors FLA% is 15% or more above setpoint #31 "MIN FLA%". See setpoint #31 on how to setup as a target type to get the hardcoded 20% out of the way.
	STAGE 3 CUT IN (Cut In/Out Control)	Stage 3 cut in, Setpoint value contains the voltage when this stage is turned on.
6	HGS PSI ON	This setpoint is used with compressors with a hot gas bypass solenoid to provide pressure control for turning on the solenoid. When this setpoint is active and the suction pressure is less than the value of this setpoint and the FLA % is within offset of setpoint #31 "MIN SLIDE%", the hot gas bypass solenoid for the compressor will be turned on. (refer to setpoint #4)
	STAGE 4 CUT IN (Cut In/Out Control)	Stage 4 cut in, Setpoint value contains the voltage when this stage is turned on.

#	Name	Description
7	HGS PSI OFF	This setpoint is used with compressors with a hot gas bypass solenoid to provide pressure control for turning off the solenoid. When this setpoint is active and the suction pressure is greater than the value of this setpoint or the FLA % is not within 25% of the setpoint #31 "MIN SLIDE%", the hot gas bypass solenoid for the compressor will be turned off. (refer to setpoint #5)
	STAGE 5 CUT IN (Cut In/Out Control)	Stage 5 cut in, Setpoint value contains the voltage when this stage is turned on.
8	L.INJECT.ON	This set point is used to control all stages of liquid injection solenoids. (These must be specified in the Liquid Injection column of the Circuit base screen.) If active and type is TARGET: Value: Liquid injection is turned on when the discharge temperature is greater than or equal to this value, and is turned off when the discharge temperature is less than this value minus the Injection Difference Temperature set point #113. Typically set at 10.0°F (5.5°C). If there are two stages, the Second stage relay will be turned on when the discharge temperature is greater than set point #8 plus 5°F (2.5°C). If the controlling SUPER HEAT is 3x its target, LIQ INJ is turned ON and remains ON until the controlling SUPER HEAT falls below 2x its target. High/Low zone cells are used to adjust these settings: The adjustment multiplier on is the value in the High Zone cell if it is greater than 0; else it is set to 3. The adjustment multiplier off is the value in the Low Zone cell if it is greater than 0; else it is set to 2. If High/Low Zone equal 0: The adjustment multiplier on is fixed at 3. The adjustment multiplier off is fixed at 2. 'Time (sec)' field: If the first liquid injection solenoid has been on for a time greater than this value, then turn on the second liquid injection solenoid. If 0 then there is no delay time.
	STAGE 6 CUT IN (Cut In/Out Control)	Stage 6 cut in, Setpoint value contains the voltage when this stage is turned on.
9	SucSprHtTarg or LEVEL TARGET	If EXV control is based upon superheat, this is the Superheat target that the Magnum will control from. If EXV control is based upon refrigerant level, this is the refrigerant level target that the Magnum will control from. 'Low Zone' if nonzero then develop control super heat based upon the lowest superheat of any compressor that is on with in this suction group else use the superheat of this compressor. 'Time (sec)' field: Seconds between samples used for calculating the Superheat Rate of Change.
	STAGE 7 CUT IN (Cut In/Out Control)	Stage 7 cut in, Setpoint value contains the voltage when this stage is turned on.
10	SPRHT ZONE +-	The value in this setpoint is added and subtracted to setpoint #9 to determine the upper and lower limits of the control zone respectively. Refer to section on EXV control. 'Time (sec)' field: If non-zero, skip ROC adjustment logic in the control zone.
	Ki-IntegMult	EXV PID Integral - Offset in Superheat= Current Superheat minus Target Superheat (setpoint #9 value field) Value is the Fast Multiplier for Kp adjustments, setback is the slow multiplier.
	STAGE 8 CUT IN (Cut In/Out Control)	Stage 8 cut in, Setpoint value contains the voltage when this stage is turned on.
11	EXV LOAD ADJ	The opening adjustment that will be made to the EXV percentage when the circuit changes to the Loading state or the closing adjustment that will be made when the circuit changes to the Unloading state. Refer to section on EXV control. Note: In MOP hold state, only closing adjustments are allowed.
	STAGE 9 CUT IN (Cut In/Out Control)	STAGE 9 cut in, Setpoint value contains the voltage when this stage is turned on.

#	Name	Description
12	EXV FINE ADJ	The adjustment is made when in the 1st zone above or below the control zone. Refer to section on EXV control.
	Kp-PropMult	EXV PID Proportional - Change in Superheat = Current Superheat minus last Superheat from 1 second ago (Rate of Change). Value is the Fast Multiplier for Kp adjustments, setback is the slow multiplier.
	STAGE 10 CUT IN (Cut In/Out Control)	Stage 10 cut in, Setpoint value contains the voltage when this stage is turned on.
13	EXV COURSE	If a course adjustment to the EXV when in the 2nd zone above or below the control zone. If the type is TIME and the time (SEC) field is greater than 1 and less than 7 then multiple the value field by the time field else multiple by 2 for adjustment amount. If a course adjustment to the EXV when in the 3rd zone above or below the control zone. Multiple value by the by 2 for adjustment amount. If a course adjustment to the EXV when above or below the 3rd zone the control zone. The value is the adjustment amount. Refer to section on EXV control. If a course adjustment to the EXV when in the 3rd zone above or below the control zone. Multiple value by the by 2 for adjustment amount. If a course adjustment to the EXV when above or below the 3rd zone the control zone. The value is the adjustment amount. Refer to section on EXV control.
	Kd-DerrMult	EXV PID Derivative - Velocity of Superheat = Current Superheat minus the Superheat from x seconds ago (setpoint #9 time seconds value). Value is the Fast Multiplier for Kp adjustments, setback is the slow multiplier.
	STAGE 11 CUT IN (Cut In/Out Control)	Stage 11 cut in, set point value contains the voltage when this stage is turned on.
14	EXV LOAD DIV	The EXV slide adjustment can be fined tuned by dividing by the value of this set point. Note the value of this set point is used regardless if the its is active or not. Refer to section on EXV control.
	Ka-AccMult	EXV PID Acceleration - Change in Velocity = Current Kd minus the Kd from x seconds ago (setpoint #9 time seconds value). Value is the Fast Multiplier for Kp adjustments, setback is the slow multiplier.
	STAGE 12 CUT IN (Cut In/Out Control)	Stage 12 cut in, Setpoint value contains the voltage when this stage is turned on.
15	ExvMinValve%	This is the minimum valve position allowed when modulating the expansion valve. This value should be set so when hot gas is applied the valve opening is adequate. Note the value of this set point is used regardless if it is active or not. Refer to section on EXV control. Note the value of this set point is used regardless if it is active or not. Refer to section on EXV control. Note the value of this set point is used regardless if it is active or not. Refer to section on EXV control.
	STAGE 13 CUT IN (Cut In/Out Control)	Stage 13 cut in, Setpoint value contains the voltage when this stage is turned on.
16	ExvMaxValve%	This is the maximum position allowed when modulating the expansion valve to maintain the superheat target. This value should be the valve % opening at full capacity plus a 10 to 15 % margin. Note the value of this set point is used regardless if the its is active or not. Refer to section on EXV control.
	STAGE 14 CUT IN (Cut In/Out Control)	Stage 14 cut in, Setpoint value contains the voltage when this stage is turned on.
17	LoSucSuperHt	If super heat is less or equal to this value and the control slope is less that the roc for zone 3 make a slide adjustment of 3 times the value of set point #13. If the calculated superheat remains below this value for the time specified in the Time (SEC) cell, the Magnum will generate a LOW SUPERHEAT alarm. Refer to section on EXV control.

#	Name	Description
	STAGE 15 CUT IN (Cut In/Out Control)	Stage 15 cut in, Setpoint value contains the voltage when this stage is turned on.
18	LOWSUCPSI DLY	Delay in seconds when in 'Low Suction PSI Opening', set point must be active, between adjustments to the EXV valve. Refer to section on EXV control..
	STAGE 16 CUT IN (Cut In/Out Control)	Stage 16 cut in, Setpoint value contains the voltage when this stage is turned on.
19	ExvKiDelay	Delay in seconds between valve adjustments. Should not be less than 48. (When adjusting at 4x this will allow 12 seconds for the controller to process the results of the last action before making the next adjustment). Refer to section on EXV control.
20	ExvStartup	This is the time in seconds to hold the valve at the start % setpoint when the compressor starts. Since the superheat calculation is not valid when the compressor is not running the EXV logic sets the valve to a given position for a set time to allow the system to develop a valid superheat. 'Time (sec)' field: If zero, then there is no delay when a compressor is ready to start. If non-zero, this is the time delay in which the EXV valve is allowed to open before the compressor starts. Refer to section on EXV control.
21	MAX TRG RESET	This set point is used to convert the voltage of a TARGET RESET type of sensor to a temperature value. This value is used to adjust setpoint #1 "CTL TARGET". The Sensor Input value will vary between 0 and 5 volts and the adjustment to the control target will be modulated from negative "MAX TRG RESET" to the positive "MAX TRG RESET" value. This set point is also used for regulating the maximum reset from the BMS. This limits the offset from the target +/- BMS can write.
22	LOW AMBIENT	If the ambient temperature is below this value the system will disabled the compressor(s) and the unit state will be set to AMBIENT OFF. The unit will remain off until the ambient temperature rises above this setpoint value by 5.0F (2.5C) or the value of set point #191 if it is active. For Low Ambient-Mechanical off type is set as Delay. This will only disable mechanical cooling when the outside air is below this SP temp value. Set the Max VFD Adjust column to 1 to enable this option.
23	POWERUP DELAY	If this set point is active the value will be the time in seconds that the system will remain in the START UP state before moving to the next state. If inactive the startup delay will be 60 seconds.
24	HI AMBIENT	If active and the ambient temperature is above this value the system will be disabled the compressor(s) and the unit state will be set to AMBIENT OFF. The unit will remain off until the ambient temperature drops below this setpoint value by 5.0F (2.5C) or the value of set point #191 if it is active.
25	STEP SENSTIY	The decrements to the time delay between making changes in the control algorithm is based upon the difference between the target and control values. If the difference is greater than 10 the delay will be reduced by 10. If less the delay will be adjusted by the value of this set point. 1 is the fastest response, whereas higher numbers will mean a more gradual response.
26	STEP DELAY	Value: This is the time delay before making adjustments to the system capacity. Refer to set point #25 for how this delay is decremented. 'Time (sec)' field: If used, this will force a minimum time delay between any two compressor starts. This time delay is specified in the 'Minimum Delay Between Compressor Starts' box in the 'Cooling Info' panel under the MAG RTU screen.
27	MAX ROC -	Compares the control value rate of change. Maximum negative Rate of Change allowed before preventing the unit from loading. If the ROC is less than this value the capacity control state is set to HOLDING.
28	MAX ROC +	Compares the control value rate of change. Maximum positive Rate of Change allowed before preventing the unit from unloading. If the ROC is greater than this value the capacity control state is set to HOLDING.

#	Name	Description
29	ROC INTERV	Seconds between samples used for calculating the Rate of Change. (Maximum 60 seconds)
30	MAX FLA% or MAX SLIDE % or MAX CAPACITY% or MAX VFD %	Indicates the maximum amp draw, slide %, digital scroll load%, or speed allowed. Usually set to 100%, else compressors will load to the value of this Setpoint until all steps are on, then the system will load to 100%. 'Time (sec)' field: If non-zero, then force individual compressors to stay at maximum capacity when another compressor starts. This option is selected in in the 'Keep Running Comp at 100% when starting next?' box in the 'Compressor Information' panel under the MAGNUM screen. 'SEC to Ignore Safety' field (Fully Loaded Screw Compressor logic): If non-zero, turn on the load solenoid every 5 min for 5 seconds when fully loaded. If zero, then do not turn on solenoid for 5 seconds every 5 minutes. 'SEC to Ignore Safety' field (Holding Screw Compressor logic): If non-zero, turn on the load solenoid every 5 min for 5 seconds when holding. If zero, then do not turn on solenoid for 5 seconds every 5 minutes.
31	MIN FLA% or MIN SLIDE % or MIN CAPACITY% or MIN VFD %	Value: Indicates the minimum amp draw, slide %, digital scroll load%, or speed allowed (usually 40%). This is where the slide valve or VFD will be set when the compressor is turned on. This % is a function of actual amp draw relative to the FLA. 'Time (sec)' field: If used, this forces a time delay before unloading all running compressors before the next compressor is started. This time delay is specified in the 'Unload Compressor Before Starting Next' box in the 'Compressor Information' panel under the MAGNUM screen. Will Delay next compressor for this time after EVAP pump/valve is opened. Target: If this set point is setup as a target type the value in the night setback column will be added to the set point VALUE to allow safety unloading all the way down to this value. This replaces a hardcoded 20%. This is also utilized in conjunction with hotgas setpoints #4 and #5 on temperature.
32	MAX ADJUST %	Value of set point contains the maximum percentage change that can be made to the slide valve or VFD. 'Time (sec)' field: A zero indicates that the calculated FLA will be used; else the value in setpoint #31 will be used when starting the next compressor. This value is specified in the 'Wanted FLA starting next Compressor' box in the 'Cooling Info' panel under the MAG RTU screen.
33	MIN ADJUST %	Indicates the minimum percentage change that can be made to the slide valve or the VFD. For Fixed Step Compressors with adjustable speed AO's when returning to 100% after shutting down another compressor, this Setpoint will be the percent of adjustment along with Setpoint #56 "PULSE DELAY" which is the time frame between capacity adjustments.
34	SLIDE SENSITY	This controls the sensitivity of the adjustment made to the Wanted Percentage (adjustments are relative to the difference between the current control sensor and target). The larger the value the larger the adjustment (usually 1).
35	AMP DB HI	Used only with screw and centrifugal compressors. If the set point type is "humidity" then the upper dead band is value times the FLA for that circuit else the value is the upper dead band limit of the FLA. If the amps are within the dead band, the slide valve will not be moved. If controlled by Slide Position, instead of FLA, this Setpoint will not be used.
36	AMP DB LO	Used only with screw and centrifugal compressors. . If the set point type is "humidity" then the lower dead band is value times the FLA for that circuit else the value is the lower dead band limit of the FLA. If the amps are within the dead band, the slide valve will not be moved. If controlled by Slide Position, instead of FLA, this Setpoint will not be used.
37	LOAD PULSE	Length of time to engage the slide valve load solenoid in tenths of a second (usually between 1 and 9). 'Time (sec)' field: If non-zero, use this value as a multiplier to increase the load pulse when the compressor's amp draw is more than three times the value of Setpoint #36 "AMP DB LO". 'SEC to Ignore Safety' field: If zero, then use delay between pulses. If non-zero, then no delay between pulses when the compressor's amp draw is more than twice the value of Setpoint #36 "AMP DB LO" away from the wanted FLA.

#	Name	Description
38	UNLOAD PULSE	Length of time to engage the slide valve unload solenoid in tenths of a second (usually between 1 and 9). Optional: If compressor type is Hanbell 3 solenoid and Time (SEC) cell of Setpoint #38, is not zero DO NOT turn the unload solenoid ON (which is normal) when the compressor is in a fast unload state, pumpdown unloading state or for the first 15 minutes after the compressor is turned off.
39	LUBE OIL TMP	If a compressor is running this set point is used as a safety. If oil temperature is less than the value for the time specified then generate an alarm. The oil must reach this temperature before the system will move out of the LUBE state. If the oil temperature is below this value before the compressor begins its startup sequence, the circuit will be placed in the OFF-LO OIL TMP state. 'Time (sec)' field: If in LUBE state, the compressor type is centrifugal, and this field is equal to 0 then the calculated oil temperature shut down is the saturated suction temperature plus the value of this setpoint, else it is simply the value of this setpoint. This option is selected in in the 'Lube State Oil Setpoint' box in the "Cooling Info" panel under the MAG RTU screen.
40	LUBE OIL PSI	The oil must reach this pressure differential between low and high oil pressure before the circuit will move out of the LUBE state.
41	LUBE DELAY	This is the maximum time that a compressor can be in the LUBE state. When this time is exceeded, an alarm is generated and the compressor is locked out. Both the oil temperature and pressure differential must be satisfied before the LUBE state will be exited. Refer to the OIL PMP LUBING state. For dual compressor units with two separate lube delays set this setpoint up as a time type . Unit state will remain in holding for lube delay (value) plus the time in the time field. The time field must be 30 seconds or greater for the logic to run correctly. 'Time/Sec' - The value in the "Time/Sec" cell is now how long we'll hold both compressors at minimum speed, once the lag compressor exits its Lube Delay and starts.
42	HI WATER TMP	If active, the control sensor's value will be compared to the value of this Setpoint. If it exceeds this temperature for the time specified in the "Time (sec)" field' a HI WATER TMP alarm will be generated. No lockouts will occur. This alarm will repeat if the control value drops .5° below this Setpoint and then rises above it again.
43	CENT P-DWN FLA	Only used with variable compressors. If active, this will be the threshold for ending the pump down state, the FLA Setpoint for that compressor will be multiplied by this value, it will be treated as a percentage. If the Setpoint is inactive then the FLA Setpoint for that compressor will be used.
44	CENT P-DWN TMR	Only used for centrifugal compressors. This is the maximum time allowed in the pump down state. NOTE: This value is used whether the Setpoint is active or inactive.
45	CND STG1 ON (RO Type)	When the discharge pressure is above this value, turn on the first stage of the condenser fans. 'Time (sec)' field: (Applies to compressors with shared condensers) If non-zero, then the compressor in startup state will not be in sole control of the condenser fans, it will control off of highest discharge pressure. If zero, then compressor in startup will have sole condenser control for 5 minutes. This option is selected in in the 'Newly started Comp Controls Common Fan Bank' box in the 'Condenser Information' panel under the MAGNUM screen.
	PID MOD Individual PID Step Common	If active, the value is the multiplier for the Proportional(Kp) adjustment, <u>Setup as Setpoint Type</u>
46	CND STG1 OFF (RO Type)	If stage 1 of condenser capacity is on and the discharge pressure drops below this value, then turn this stage off.
	PID MOD Individual PID Step Common	If active, uses Multiplier for Ki adjustments (Integral Time Delay). <u>Setup as Time Field</u>
47	CND DIFF ON (RO Type)	Differential pressure added to Setpoint #45 to set the threshold at which each additional stage of condenser capacity will turn on.
	PID MOD Individual PID Step Common	If active, use Multiplier for Kd adjustments, <u>Setup as Time Field</u> - <u>Time (sec) field is ROC window.</u>

#	Name	Description
48	CND DIFF OFF (RO Type)	Differential pressure added to Setpoint #46 to set the threshold at which each additional stage of condenser capacity will turn off.
	CND ADJ DELAY (Modulating Type)	If active this is the time in seconds between condenser adjustments to the AO. If inactive, then 30 seconds will be used as the delay. If type is DELAY: (required for condenser relay delays). -MIN VFD Opening cell contains the time delay between turning on a relay and moving the AO to its minimum position (Setpoint #52). -MAX VFD Opening cell contains the time delay between turning off a relay and moving the AO to 100%.
	DUAL PSI DELTA (Dual V8)	Minimum difference in pressure before the second stage of condenser capacity can be started.
49	CND MIN RUN (RO Type)	Once a condenser stage has been turned on, it will remain on for at least the amount of minutes specified in this Setpoint. Time (SEC) column number is used to designate Cond Fan AO stage. Inactive with value of 0, min of 0 and max of 0, in all config files.
	DUAL TIME DELAY (Dual V8)	Time delay once the pressure difference in Setpoint #48 has been reached before the second condenser stage can be started.
	CND START % (Modulating Type)	If active, then the value is the starting % for the AO when the RO that is tied to it turns on. The value in the "Time (SEC)" cell is the AO starting stage. If no Relays are used when CMP starts set value.
50	CND TRGT (Modulating Type)	Target logic will try to maintain modulating the AO. SP must be set up as target type and use the Hi/Low zones for the target control zone. If target type in HP mode, setback is added to target.
	LO AMB SUMP OFF (RO Type)	If active and ambient temperature is less than the value of this Setpoint, then the sump pump relay will be locked off if it is the starting condenser Relay Output. When the ambient temperature rises above the value of this Setpoint plus two times the value in Setpoint #192 "FRZ TEMP DIFF" if active (hardcoded 15°F if inactive), then the sump pump relay will be allowed on again.
51	CND ADJ DIV (Modulating Type)	Controls scaling of the amount the AO is adjusted (usually 1). The larger the number the smaller the AO adjustment as the adjustment will be divided by this value.
	CND VFD MIN	If there is a VFD associated with the condenser, this is the starting minimum speed. 'Time (sec)' field: This field contains the condenser stage that must be on before the VFD is modulated.
52	CND MIN % (Modulating Type)	Minimum AO % allowed. If compressor is off, then check the "Time (SEC)" field: If 0, then the AO % will be set to the value of this Setpoint. If 2 and the run/stop is set to run, then set the AO % to 100%, else set the AO % to 0%. This option is selected in the "Default Valve Opening % when Comp. is OFF" box in the condenser information section in the MAG HVAC screen.
53	CND ROC (Modulating Type)	Maximum negative rate of change allowed. If the rate of change is less than this Setpoint, then stop modulating the AO. The absolute value of this Setpoint also serves as the maximum positive rate of change allowed. If the rate of change is greater than the absolute value of this Setpoint, then stop modulating the AO.
54	CND MIN SPD (RO Type)	Minimum speed percentage for variable speed condenser control.
	CND ADJ MULT (Modulating Type)	Controls scaling of the amount the AO is adjusted. The larger the number the larger the AO adjustment as the adjustment will be multiplied by this value.
55	CND MAX SPD (RO Type)	Maximum speed percentage for variable speed condenser control.
	CND MIN ADJ (Modulating Type)	The value in this Setpoint is the minimum % the AO will be modulated when a change is made.

#	Name	Description
56	PULSE DELAY	Used with variable capacity screws. The number of seconds between load or unload pulses (Usually between 3 and 5. Allows load change to be checked before next pulse and eliminates oil foaming when unloading too fast). 'Time (sec)' field: If used, this is the fast unloading state time delay. This option is selected in in the 'Fast Unload Delay' box in the 'Compressor Information' panel under the MAGNUM screen. For Fixed Step Compressors with adjustable speed AO's when returning to 100% after shutting down another compressor, this Setpoint will be the time frame between capacity adjustments along with Setpoint #33 "MIN ADJUST %" which is the percent of adjustment.
57	LO AMB PROC	When this Setpoint is active and there is a process pump, the process pump will be turned on when the ambient temperature is less than the value of this Setpoint. The process pump will be turned off again when the ambient temperature is 5.0° Fahrenheit greater than the value of this Setpoint.
58	CFG TESTING	This must be setup as 'Not Used'. If active the system will not lockout when an I/O communications signal is lost. This Setpoint should NOT be active in a live unit.
59	ACYC OFF->ON	This is the anti-cycle time delay (in seconds) from when the compressor was turned off. This value is used in a calculation to determine how long a compressor should be in the anti-cycle state. Refer to the Standard Control Options in manual, Compressor Anti- Cycle Logic (OFF to ON).
60	MITSI P-DWN CUTIN	If the compressor is a Mitsubishi, is being unloaded, and the suction pressure is greater than this Setpoint, then the compressor will be forced to pump down. NOTE: this value is used whether the Setpoint is active or inactive.
61	PMP DWN OFF	This is the suction pressure value for turning off the compressor when in the PUMP DOWN or for opening the liquid line solenoid during the PRE-PUMP down state.
62	PMP DWN DELY (CENT only)	In CENT Firmware this SP value is the post lube delay. The oil pump will remain on for this amount of time after the compressor stops drawing amperage.
63	ACYC ON->ON	This is the anti-cycle time delay (in seconds) from when the compressor was turned on. This value is used in a calculation to determine how long a compressor should be in the anti-cycle state. Refer to the Standard Control Options in manual, Compressor Anti- Cycle Logic (ON to ON).
64	COMP MIN RUN	This is the minimum run time (in minutes) for a compressor once it is turned on. This minimum run time can be overridden by a safety condition, however.
65	EXV ZONE1	Temperature differential used to build the EXV Zone 1 both plus and minus.
	SCExvTarget	SC SUPERHEAT TARGET - SC SUPERHEAT AVERAGE THIS # SECONDS - <u>Setup as Target</u>
66	EXV ZONE2	Temperature differential that is used to build the EXV Zone 2 both plus and minus. Temperatures above this zone are considered in zone 3.
	SCExvKIntegr	SC SUPERHEAT CONTROL ZONE - SC MPLY Ki) FOR VALVE ADJ WHEN IN FAST ZONE- <u>Setup as Target</u>
67	EXV ROC ZONE 1	The EXV control logic will compare the value of this Setpoint to the temperature rate of change to determine the valve adjustment when the temperature is within the EXV control zone. 'Safety Down Time (MIN)' field: The minimum time delay between EXV adjustments when in the EXV control zone.
	SCEXvKProp	SC SUPERHEAT MULTIPLIER (Kp) -SC RATE OF CHG MULTIPLIER - <u>Setup as Target</u>
68	EXV ROC ZONE1	The EXV control logic will compare the value of this Setpoint to the temperature rate of change to determine the valve adjustment when the temperature is within zone 1. 'Safety Down Time (MIN)' field: This is the minimum time delay between EXV adjustments when in the EXV control zone 1. If this Setpoint is inactive then the ROC for this zone is 0 and the delay is 15 seconds.
	SCExvKDeriv	SC ADJUST LIMIT IN FAST ZONE (Kd) Velocity of Superheat - SC OUTSIDE FAST ZONE ADJ LIMIT

#	Name	Description
69	EXV ROC ZONE2	The EXV control logic will compare the value of this Setpoint to the temperature rate of change to determine the valve adjustment when the temperature is within zone 2. 'Safety Down Time (MIN)' field: This is the minimum time delay between EXV adjustments when in the EXV control zone 2. If this Setpoint is inactive then the ROC for this zone is 0 and the delay is 15 seconds.
	SCExvKAccel	<u>Setup as Target</u>
70	EXV ROC ZONE3	The EXV control logic will compare the value of this Setpoint to the temperature rate of change to determine the valve adjustment when the temperature is within zone 3. 'Safety Down Time (MIN)' field: This is the minimum time delay between EXV adjustments when in the EXV control zone 3. If this Setpoint is inactive then the ROC for this zone is 0 and the delay is 15 seconds.
	SCLowSprht	SC LOW SUPERHEAT SAFETY - SC LOW SH TIME TO SAFETY - <u>Setup as Alarm</u>
71	EXV TOO FAST	When the superheat is with the control zone, the EXV control logic will compare the value of this Setpoint to the temperature rate of change to determine the valve adjustment when the temperature is within the zone and rising too fast. 'Safety Down Time (MIN)' field: This is the minimum time delay between EXV adjustments if the rate of change is too fast when in EXV control zones 1 or 2. If this Setpoint is inactive then the ROC for this zone is 0 and the delay is 15 seconds.
	SCExvKiDelay	SC SECONDS DELAY BETWEEN ADJUSTMENTS (Ki) - <u>Setup as Setpoint</u>
72	EXV CHANGING	When the superheat is with the control zone, the EXV control logic will compare the value of this Setpoint to the temperature rate of change to determine the valve adjustment when the temperature is within the zone and rising.
	SCExvStartup	<u>Setup as Setpoint</u>
73	STARTER DLAY	This Setpoint controls the start of a compressor's second relay. If the 'Select Value: # decimals & print char' cell is set to 'HUMD or %' then logic is: If First Compressor Relay has been on longer than 2 seconds and the FLA% goes below the value of this setpoint or is still above the value but reaches the time value in the safety time field than turn on the second relay. (If the low zone field is zero use the hardcoded 2 seconds delay at start. If greater than zero use that value). Setpoint Information Screen, if the ' Select Value: # decimals & print char ' cell is set to 'Seconds' then the Setpoints value is a time delay between the first and second relay's start. Used for part wind (typical value of 1) and star delta (typical value of 5) starter.
74	OIL PUMP OFF	If oil pump is set up to cycle and discharge psi minus, etc.(specified in MCS-Config), this Setpoint is not used. If Discharge PSI minus Suction PSI is less than Setpoint #74 minus 10 PSI than turn on the oil pump RO. If Discharge PSI minus Suction PSI is greater than Setpoint #74, turn off the oil pump RO.
75	HI AMPS	This Setpoint is a percentage of the FLA; it is used to create the high amp draw limit. The value of this Setpoint is multiplied by the respective compressor's full load amps Setpoint (#171 through #190) to obtain its upper limit. If the compressor's amps exceed this value for the time specified in this Setpoint, then a safety trip occurs. Hi amp unloading logic. If amp reading exceeds half way point between FLA set point and Hi amp FLA %, compressor will unload and enter Hi amp unloading state. Compressor will remain in this state and unload until the amp reading is less than or equal to 100% of FLA set point.
76	LO AMPS	This Setpoint is a percentage of the FLA; it is used to create the low amp draw limit. The value of this Setpoint is multiplied by the respective compressor's full load amps Setpoint (#171 through #190) to obtain its lower limit. If the compressor's amps fall below this value for the time specified in this Setpoint, then a safety trip occurs.

#	Name	Description
77	LOW SUCTION	If active, the Magnum checks for low suction pressure for each running compressor. If suction pressure is less than this value for the specified period of time, a safety trip occurs. Refers to 'Suction Pressure' column in the Circuit SI screen.
78	LO SUCT UNLD	The purpose of this Setpoint is to take corrective action to prevent a low suction pressure safety trip. For fixed step compressors: If a compressor has more than one step, is fully loaded, and if the suction pressure is less than the value of Setpoint #77 "LOW SUCTION" plus the value of this Setpoint, then one step of capacity will be turned off. For variable step compressors: If a compressor has a suction pressure less than the value of Setpoint #77 "LOW SUCTION" plus the value of this Setpoint, then the compressor will be forced to unload. The circuit state will be changed to LO SUCT HOLD, and will remain in this state for a minimum of the time in Setpoint #101 "SAFETY HOLD DELAY". At that time, if the suction pressure has increased greater than the value of Setpoint #77 "LOW SUCTION" plus the value of Setpoint #79 "LOW SUCT RELD" the compressor will return to normal control. Time (SEC) column contains delay before Lo Suct PSI unloading. Used with unit that has EXV logic. This delay before unloading allows the "Low suction PSI opening" EXV control state to open the valve to increase pressure.
79	LOW SUCT RELD	Refer to Setpoint #78 description.
80	UNSAFE SUCT	If active, the Magnum checks for unsafely low suction pressure for each running compressor. If suction pressure is less than this value for the specified period of time a lockout occurs (can be configured as a regular safety with automatic reset if 'Setpoint Type' is Setpoint instead of Lockout). NOTE: The time period specified should be very short (2-5 seconds). If this Setpoint trips, the compressor will be sent straight to the Lockout state. Refers to 'Suction Pressure' column in the Circuit SI screen.
81	HI DISC PSI	If active, the Magnum checks for high discharge pressure for each running compressor. If the discharge pressure sensor reads greater than this Setpoint for the specified period of time, a safety trip will occur. Refers to 'Discharge Pressure' column in the Circuit SI screen.
82	HI DISC UNLD	The purpose of this Setpoint is to take corrective action to prevent a high discharge pressure safety trip. For fixed step compressors: If a compressor has more than one step, is fully loaded, and if the discharge pressure is more than the value of Setpoint #81 "HI DISC PSI" minus the value of this Setpoint, then one step of capacity will be turned off. For variable step compressors: If a compressor has a discharge pressure more than the value of Setpoint #81 "HI DISC PSI" minus the value of this Setpoint, then the compressor will be forced to unload. The circuit state will be changed to HI DISC HOLD, and will remain in this state for a minimum of the time in Setpoint #101 "SAFETY HOLD DELAY". At that time, if the discharge pressure has decreased below the value of Setpoint #81 "HI DISC PSI" minus the value of Setpoint #83 "HI DISC RELD" the compressor will return to normal control.
83	HI DISC RELD	Refer to Setpoint #82 description.
84	LO DISC SHEAT	If the calculated discharge superheat is less than this value for the specified period of time, a safety trip will occur. Also, there is an option in the Circuit Base screen to tie a Relay Output to this Setpoint that will activate whenever a low discharge superheat condition occurs. A Low Discharge Superheat condition can also put the circuit into a 'HI DISC UNLOAD' state where the compressor will unload to try to raise the superheat. If economizer is being used, when the discharge superheat goes below the value for the safety time / 9 the economizer is turned off.
85	LO DISC PSI	If active, the Magnum checks for low discharge pressure. If the discharge sensor reading is less than this value for the specified period of time, a safety trip occurs.
86	HI RETURN TEMP	Only active in Mitsubishi compressors. If active the Magnum will check for high entering liquid temperature. If this temperature is greater than the value in this Setpoint, the circuit state will be HI WATER HOLD.

#	Name	Description
87	HI DISC TMP	If active, the Magnum checks for high discharge temperature for each compressor. If the discharge temperature sensor reading is greater than this Setpoint for the specified period of time, a safety trip will occur. Refers to 'Discharge Temperature' column in the Circuit SI screen.
88	DIS TMP UNLD	The purpose of this Setpoint is to take corrective action to prevent a high discharge temperature safety trip. For fixed step compressors: If a compressor has more than one step, is fully loaded, and if the discharge temperature is more than the value of Setpoint #87 "HI DISC TMP" minus the value of this Setpoint, then one step of capacity will be turned off. For variable step compressors: If a compressor has a discharge temperature more than the value of Setpoint #87 "HI DISC TMP" minus the value of this Setpoint, then the compressor will be forced to unload. The circuit state will be changed to HI DISC HOLD, and will remain in this state for a minimum of the time in Setpoint #101 "SAFETY HOLD DELAY". At that time, if the discharge temperature has decreased below than the value of Setpoint #87 "HI DISC TMP" minus the value of Setpoint #89 "HDISC T RELD" the compressor will return to normal control.
89	DIS TMP RELD	Refer to Setpoint #88 description.
90	COND FAULT	For Condensers with Fault Indicators: If Setpoint is active, a condenser fault occurs, and the Setpoint type is Alarm, then an alarm message will be generated. If the type is Lockout, and a condenser fault occurs, then all of the compressors associated with this fault will be locked off. For Common VFD Fan Condensers with Bypass: Time in seconds before the bypass can be used when a fault has occurred.
91	LOW OIL DIF	If active, the Magnum checks for low differential oil pressure. If the calculated differential oil pressure is less than this value for the specified period of time, a safety trip occurs. Refers to 'Oil Pressure' column in the Circuit SI screen.
92	UNSAFE OIL	If active, the Magnum checks for unsafe differential oil pressure. If the calculated differential oil pressure is less than this value for the specified period of time, a lockout occurs. NOTE: The time period specified should be very short (2-5 seconds). If this Setpoint trips, the compressor will be sent straight to the Lockout state. Refers to 'Oil Pressure' column in the Circuit SI screen.
93	HI OIL SEAL	Only used with screw or centrifugal compressors. If the oil seal or oil cooler temperature exceed the value of this Setpoint for the time specified, a safety trip occurs. Refers to 'Oil Seal Temp' column in Circuit SI screen.
94	HI OIL TEMP	If active, the Magnum checks for high oil temperature. The sensor can be either an analog or digital input. If the oil temperature sensor reading is ON (Digital) or exceeding the temperature value of this Setpoint (Analog) for the specified period of time, a safety trip occurs. Refers to 'Oil Temp' column in the Circuit SI screen.
95	MOTOR FAULT	If active, the Magnum checks for high motor temperature. The sensor can be either an analog or digital input. If the motor temperature sensor reading is ON (Digital) or exceeding the temperature value of this Setpoint (Analog) for the specified period of time, a safety trip occurs. Refers to 'Motor Temp' column in the Circuit SI screen.
96	NO CMP PROOF	If active, when the compressor is called to be on by the controller, the Magnum will check for a digital input to indicate that the compressor is indeed running. If the controller calls for a compressor to turn on and no proof is given in the specified period of time, a safety trip occurs. Refers to 'Comp Proof' column in the Circuit Base screen
97	DIRTY FILTER	Only used for screw compressors. If discharge pressure minus oil filter pressure is greater than this value for the time specified, a safety trip occurs.

#	Name	Description
98	LLS#2 ON	<p>This Setpoint is used to control a second liquid line solenoid. When the actual circuit capacity is greater than this value (can either be number of steps for Fixed Step compressors, or percentage of full load amps for Variable Step compressors) for the number of seconds in the 'Time (sec)' field, the second liquid line solenoid will open. When the actual circuit capacity falls below this value minus the 'Lockout Delay Hrs.' Field, then the second liquid line will be turned off.</p> <p>'Time (sec)' field: The delay in seconds before the solenoid will be turned on. If zero, then there will be no delay.</p> <p>'Lockout Delay Hrs.' Field: Offset that will be subtracted from the value of this Setpoint. When the actual circuit capacity falls below this offset, the solenoid will be turned off. If zero, then an offset of 20% will be used.</p>
99	LLS#3 ON (ECONOMIZER)	<p>This Setpoint is used to control a third liquid line solenoid. When the actual circuit capacity is greater than this value (can either be number of steps for Fixed Step compressors, or percentage of full load amps for Variable Step compressors) for the number of seconds in the 'Time (sec)' field, the third liquid line solenoid will open. When the actual circuit capacity falls below this value minus the 'Lockout Delay Hrs.' Field, then the third liquid line will be turned off.</p> <p>'Time (sec)' field: The delay in seconds before the solenoid will be turned on. If zero, then there will be no delay.</p> <p>'Lockout Delay Hrs.' Field: Offset that will be subtracted from the value of this Setpoint. When the actual circuit capacity falls below this offset, the solenoid will be turned off. If zero, then an offset of 20% will be used.</p> <p>If the LO DISC SHEAT Setpoint #84 is active and the discharge superheat goes below the value in this Setpoint for the safety time / 9, the economizer will be turned off.</p>
100	HIGH SUMP TEMP	If active, and sump temperature is above the value of this Setpoint for the time specified, a HIGH SUMP TEMP alarm is generated and the unit is locked out.
101	SAFETY HOLD DELAY	<p>Time in seconds that the circuit will remain in a hold state after the condition that caused it has returned to normal. The circuit can be holding for the following reasons:</p> <ul style="list-style-type: none"> ■ Low suction pressure ■ Low refrigerant temperature ■ High discharge pressure ■ High discharge temperature ■ High amperage
102	PUMP FREEZE PROTECTION	If active, and the leaving temperature sensor is below the value of this Setpoint, a pump will be forced on to protect against freezing. The leaving temperature must rise above this Setpoint plus Setpoint #192 "FRZ TMP DIFF" to turn the pump off again.
103	LEAD COMP	<p>If type is Setpoint: Enables the user to specify the lead compressor. The value of this Setpoint will indicate the lead compressor. If zero, then auto rotation is enabled.</p> <p>'Time (sec)' field: If non-zero, the compressor with the least amount of run time will become the lead upon rotation.</p> <p>If type is Target and the value is 0: Indicates that special rotation for dual barrel systems will be used. Refer to section on Custom Rotation.</p>
104	COMP ROTATION	Specifies the number of days between rotations (Setpoint #103 must be set to zero to enable auto rotation). If zero, then rotation will occur with every cycle.

#	Name	Description
105	PUMP FAILURE (NO FLOW)	<p>If active, flow is lost, and only one pump is present, then the system will be locked out. If the system has two pumps and flow is lost, then the backup pump will start and the lead pump will be locked out. If the second pump is running and flow is lost again then the entire system will be locked out. A lock out reset will be required to restart the system or to reactivate a locked out pump.</p> <p>If inactive, and the flow is lost, the system will move to the OFF- NO EVAP FLOW state. When flow is returned the system will automatically restart.</p> <p>If looking at individual pumps for each circuit in the Circuit base, make this Setpoint a "Lockout". If flow is not made within the value of this Setpoint the first time than, an alarm will be generated. The system counts through the value of this Setpoint a second time, if flow is made then the unit will run as normal. If flow is not made the second time, the pump and all associated compressors for that circuit will be locked out.</p> <p>If the setpoint lockout delay (hrs) is set to 0 then the circuit will LOCK OUT on the first NO FLOW proof.</p>
106	LEAD PUMP	Indicates which pump is the lead. If zero, then rotation of the pumps will occur whenever the lead pump is turned off. If no rotation has occurred during the current day, a forced rotation will occur at midnight, ensuring at least one rotation per day. If value is non-zero, then rotation of the pumps is inactive and the value will specify the lead pump. This Setpoint can be changed in a live unit and the appropriate action will be taken immediately.
107	EcoDelayMech	<p>Seconds to delay after the economizer is fully loaded, valve opened to its maximum, and all associated fans are on before the mechanical cooling is enabled. If inactive, then the value of Setpoint #125 "Eco StageDly" will be used for this delay.</p> <p>'Time (sec)' field: This value is used as a multiplier in the calculation that determines when it is too cold to use economizer cooling. If the control temperature drops below Setpoint #1 "CTL TARGET" minus ('Time (sec)' field of this Setpoint multiplied by the value of Setpoint #3 "CTL ZONE -") then shut off all economizer cooling. If the value in this 'Time (sec)' field is zero, a hardcoded 3 will be used instead.</p>
108	PUMP DELAY	Time in seconds to keep the chilled water pump running after the last compressor has been turned off to ensure the chiller barrel does not freeze.
109	HiRefLevel	<p>This Setpoint has two functions.</p> <p>If active, the Magnum checks for high refrigeration level. If the refrigeration level sensor is above than this value for the specified period of time, a safety trip occurs.</p> <p>If active, system has EXV valve control based on refrigerant level, and the refrigerant level is greater than this value, then the EXV valve adjustment will be set to the value in Setpoint #13 "EXV COURSE" * (-3).</p> <p>Refers to 'Refrig Level' column in the Circuit SI screen</p>
110	RefLvlExvAdj (EXV Control: Refrigerant Level)	If Setpoint #84 "LO DiscSPRHT" is active and it has reached one third of its safety time, then Setpoint #9 "REF LVL TRG" will be set to the value of this Setpoint. The purpose is to decrease the EXV valve opening to avoid a low discharge superheat safety trip. This change will be updated in the Setpoint status value.
	DSprhtExvAdj (EXV Control: Dis- charge or Suction Superheat)	If Setpoint #84 "LO DiscSPRHT" is active and it has reached one third of its safety time, then Setpoint #9 "SUPERHT TRGT" will be increased by the value of this Setpoint. The purpose is to decrease the EXV valve opening to avoid a low discharge superheat safety trip.
111	FREEZE	If active, the Magnum will compare the leaving temperature to this Setpoint. If it is less than this value for the specified period of time, a safety trip occurs.
112	NO STOP	This Setpoint is used to ensure that a compressor is actually off when the controller calls for it to be off. This Setpoint contains a percentage of the FLA for Setpoints #171-189. If the compressor amperage is greater than this percentage of the FLA Setpoint for the specified period of time, signaling that the compressor is still running, then the entire system is locked out and a NO STOP alarm is generated. If a Control Power relay is specified, then it will be turned off when this safety trips.
113	OIL INJ TEMP DIFF	This is a temperature differential subtracted from Setpoint #8 to control the oil injection relay. When discharge temperature is above this differential, then oil injection is turned on. If inactive then value will be 5.6° F (2.8° C).
114	OIL TEMP DIFF	This is a temperature differential used in controlling the oil heater and second liquid line solenoid. If inactive then value will be set to 5° F.

#	Name	Description
115	EcoVFDfanDely	If active, and the fluid cooler has a VFD condenser fan, this Setpoint will be the time in seconds between adjustments to the VFD. If inactive, then the value of Setpoint #124 "EcoVlvAdjDly" will be used for this delay timer.
116	Defrost On Temp	Only used in Turbo Ice Machines. When control temperature falls below this value, then a defrost cycle begins. When the temperature rises .5° F above this value then the defrost cycle will be terminated.
117	Defrost On Delay	Only used in Turbo Ice Machines. Time in seconds of pre-defrost delay.
118	Defrost On Cycle	Only used in Turbo Ice Machines. Time in defrost cycle for each circuit.
119	EcoOffsetON	Temperature offset to determine when the economizer can be used. The ambient temperature must be less than Setpoint #1 "CTL TARGET" minus the value of this Setpoint for the economizer to begin.
120	Eco Stg Dely	Once the economizer valve has been opened to its maximum and all fans associated only with it have been turned on, the economizer function will wait this time in seconds before the first condenser fan is turned on or VFD is set to its minimum position. The minimum setting of the VFD is the value of Setpoint #54 "CND MIN SPD".
	H-PMP SW TIME	Time delay for switching between heating and cooling modes for heat pumps.
121	Eco MIN VLV%	Minimum Economizer Analog Output valve percentage. This will be the value used when first starting the economizer function as well as the lowest level before turning off. This Setpoint must be active to indicate that the Economizer AO option is active.
122	Eco MAX VLV%	Maximum Economizer Analog Output valve percentage.
123	Eco MAX ADJ	Maximum adjustment to the Economizer Analog Output valve percentage with each calculation. Formula:[absolute value of(Target – current) * Multiplier Setpoint #126] / Divisor Setpoint #127
124	EcoVlvAdjDly	Delay between Economizer Analog Output valve adjustments.
125	Eco StageDly	Time delay between economizer reaching its maximum opening and turning on the associated condenser fans. If no condenser fans associated, then this Setpoint needs to be 0 and non-active.
126	Eco MULTI	Multiplier to scale adjustments to the Economizer Analog Output valve percentage. The difference between the control sensor and its target will be multiplied by this value.
127	Eco DIVIDE	Divisor to scale adjustments to the Economizer Analog Output valve percentage. The difference between the control sensor and its target will be divided by this value.
128	CmpMinSpeed%	This is the minimum allowed compressor speed. This value will dynamically change based on an internal calculation, but will never be less than the original number.
129	CmpMaxSpeed%	This is the maximum allowed compressor speed.
130	CmpSpdUnld%	The value in this Setpoint is the actual % decrease in this adjustment to the compressor AO, when adjusting to meet the calculated Wanted %. Cannot be greater than 1.
131	NOT USED	
132	MinLiftTemp	This is the minimum allowed lift temperature. Refer to Setpoint #128 "CmpMinSpeed%".
133	MaxLiftTemp	This is the maximum allowed lift temperature. Refer to Setpoint #128 "CmpMinSpeed%"
134	BARREL HEATER	If ambient falls below this temperature, then the barrel heater will turn on.
135	REFRIG LEAK	Used to detect a digital signal from a refrigerant leak detector.

#	Name	Description
136	VI PULSE	Used with an adjustable VI, volume ratio. This is the pulse time expressed in tenths of a second to adjust the VI.
137	VI DEADBAND	Used with an adjustable VI, volume ratio. If the VI reading is greater than the VI wanted ratio plus the value of this Setpoint, then the increase RO is off and the decrease RO is pulsed. If the VI reading is less than the VI wanted ratio minus the value of this Setpoint, then the increase RO is pulsed and the decrease RO is off.
138	VI DELAY	This is the time delay between VI wanted ratio calculations.
139	OIL FLOAT	If active, the Magnum checks for an oil float digital input. It must be ON for the period of time specified in the Setpoint before this Setpoint will trip.
140	NOT USED	
141	NOT USED	.
142	SERVICE MODE	If non-zero, then a compressor being disabled by the pump down switch will be continue to run until its suction pressure is zero. The compressor will be turned on to perform the pump down the number of times indicated in this Setpoint. This is in preparation for service to be performed on the compressor.
143	UNLOADED %	Used if a slide percentage sensor is present. When this sensor is reading less than the value of this Setpoint, then the slide is considered unloaded. Also used for a centrifugal vane closed. If the vane% sensor is reading less than the value of this Setpoint, then the vane is considered closed. Optional: If Setpoint is set up as a target, the value of this Setpoint equals the % at which the slide is considered closed. If the Time(SEC) field is set > 0 then slide control will be used instead of AMPS. High & low zone are used to develop the control zone based upon the capacity wanted %. Make Setpoint #35 "AMP DB HI" and Setpoint #36 "AMP DB LO" non-active.
144	OIL HEATER ON	The oil heater will be turned on if the oil temperature is less than the value of this Setpoint. It will be turned off if the oil temperature is greater than the value of this Setpoint plus 5.0° Fahrenheit. 'Time (sec)' field: If zero, then the calculated oil temp will be the saturated suction temperature plus the value of the Setpoint. Else it will be the value of this Setpoint.
145	OIL COOLER ON	The oil cooler will be turned on if the oil seal temperature is greater than the value of this Setpoint. It will be turned off if the oil seal temperature is less than the value of this Setpoint minus 5.0° Fahrenheit.
146	PROC TARG	Process pump target. The control value can be either temperature or pressure.
147	PROC ZONE	Process pump control zone. This value is added to Setpoint #146 "PROC TARG" to calculate the high value and subtracted to calculate the low value of the control zone. The process pump's VFD will be modulated to maintain inside this zone. The adjustment to the pump speed is calculated by subtracting the controlling SI from the value of Setpoint #146. This range has a minimum of 1% ADJ and a maximum of 15%.
148	PROC DELY	Process pump delay in seconds before next change. If calculated adjustment (Target minus controlling SI) is greater than the zone x2, or if the slope is greater than the ROC x2, decrement twice as fast.
149	PROC MAX ROC	Process pump rate of change limit. If the ROC exceeds this value, no change is required. The ROC window equals the value of Setpoint 148 to a maximum of 60 seconds.
150	PROC MIN SPD%	Minimum process pump speed if using the Modulating (AO) option. Number of Relay Outputs that will be staged if using the Staging (RO) option.
151	UNLOADED OFF	If active, the system is fully unloaded, and the control temperature is greater than this value, then the capacity state will be set to holding. 'Time (sec)' field: If non-zero, then the value of this Setpoint is used as a differential and not a set temperature. The value of this Setpoint is subtracted from Setpoint #1.

#	Name	Description
152	HP OVERHEAT	This Setpoint is only used when the heat pump option has been selected in the 'Unit Type' box in the 'General Information' panel under the MAGNUM screen. It is used to protect against a heat pump with unloaders (or variable speed) from overheating. When this Setpoint is active and the leaving temperature sensor is greater than this Setpoint minus 3.0° Fahrenheit, then the compressor will enter HIGH TEMP UNLOAD state. The temperature must drop to less than this Setpoint minus 4.5° Fahrenheit before the system will move to the holding state.
153	SftyUnld Del	The time delay in seconds between compressor capacity adjustments when safety unloading.
154	VFD Sfty Adj	The VFD percentage adjustment to be made after every amount of time in Setpoint #153 "SftyUnld Del" when safety unloading.
155	LO REF TMP	If active, the Magnum checks for low refrigerant temperature. If the refrigerant temperature is less than the value of this Setpoint for the specified period of time, a safety trip occurs.
156	LO REF UNLD	The purpose of this Setpoint is to take preventative action before a low refrigerant temperature safety trip. The compressor will unload when the refrigerant temperature is less than the value of the Setpoint #155 "LO REF TMP" plus this Setpoint. The compressor state will be changed to LO TMP UNLOAD. The compressor will remain in this state until the refrigerant temperature is above the value of Setpoint #155 "LO REF TMP" plus twice the value of this Setpoint. The compressor state change to LO TMP HOLD.
157	COV LIFT TEMP	Minimum change to the saturated lift before calculating a new minimum speed.
	B-PUMP DELAY (Boiler/Pump Control)	The time delay expressed as seconds between making decisions as to pump settings.
158	NOT USED	
159	B-STAGE DELY (Boiler/Pump Control)	The time delay expressed as seconds between making decisions as to boiler stage settings.
	AdaptPurgOff	Is optional and required when using adaptive purge mode. This setpoint's value contains the time (in minutes) to turn off the external purge system when no purge exhaust cycles have been detected.
160	DEF REV DEL	If a reversing valve is used, this is the delay in minutes the system must wait once the valve has been opened before the defrost cycle can continue.
	B-VFD TARGET (Boiler/Pump Control)	The target flow that is to be maintained. This can be a differential if both input and output pressures sensors are specified or the actual flow of the input if only sensor specified. 'Time(sec)' field: contains the delay in seconds before another pump can be turned on once the valve gets to 100.0% 'Sec. to Ignore Safety' field: contains high dead band for the control zone. This is added to the value of this set point. In this example the high dead band will be 63.0. 'Window to extend Safety Time(sec)' field: contains low dead band for the control zone. This is subtracted from the value of this set point. In this example the low dead band will be 57.5. 'Safety Time Extension' field: contains the maximum valve adjustment that can be made at one time. In this example the maximum adjustment to the valve will be 3.0%..
	AdaptNoPurge	Is optional and is required when using the adaptive purge mode. This setpoint's value contains the time (in minutes) required for the purge enable relay to be ON without any purge exhaust cycles before the adaptive purge logic will turn off the purge enable relay.
161	NOT USED	
	B-PUMP FLT (Boiler/Pump Control)	The 'Value' is not used as this set point is set up to check the status of a digital input indicated in the Starting Pump Fault cell. 'Time(sec)' field: contains the delay before the system will place a pump in a failed state.

#	Name	Description
162	NOT USED	
163	Purge Target	When active, it enables MCS-Magnum's external purge logic and its value to be used to trigger the purge exhaust cycle. When the purge suction temperature is less than or equal to this setpoint value, a purge exhaust cycle is started. For example, Purge exhaust pump turns on and 1 second later purge solenoid is turned on. When the purge suction temperature rises above setpoint #163 value field + Setpoint #163 Safety Time field, the purge exhaust cycle is stopped and purge exhaust pump relay is turned off and 1 second later the purge solenoid is turned off.
	B-HEAT TRGT (Boiler/Pump Control)	The heating target that is to be maintained.
164	PurgeFltTime	If active and the purge safety sensor input is setup (not equal to UNUSED) the purge fault logic is run. The purge fault logic looks for the purge fault sensor input to be ON for 10 seconds (setpoint #164 value field) before generating a Purge Fault alarm and lockout the external purge system.
	B-HEAT ZONE+ (Boiler/Pump Control)	The high dead band for the heating control zone. This value is added to the value of set point #163.
165	Purge ExhTime	If active and the exhaust purge system has been in the purge exhaust cycle for more than 120 minutes (Setpoint #165 value field) an Excessive Purging alarm is generated.
	B-HEAT ZONE- (Boiler/Pump Control)	The low dead band for the heating control zone. This value is subtracted from the value of set point #163.
166	PHASE LOSS	If active and the phase loss digital input sensor is ON for the specified period of time, a safety trip occurs. The system will attempt to restart after waiting the number of minutes contained in the 'Safety Down Time' field of this Setpoint.
167	PURGE FLT ERROR	If active and purge float error occurs, a purge float alarm is generated. This Fault requires a lockout reset to resume purge operation.
168	PURGE COUNT	If the total number of purges that occurred during the last three purge cycles exceed this value, then reset all counters and generate a Maximum Purges Exceeded alarm. For the first thirty minutes of compressor run time – this alarm is by passed.
169	PURGE PSI ST	When the purge pressure sensor reading is equal or greater than this value, then a purge cycle will be initiated. The cycle will end when the purge pressure sensor reading is less than the value of this Setpoint minus Setpoint #193 "PSI DIFF", or 5 psi if inactive.
170	EXCESS PURGE	If the time in a purge cycle exceeds this Setpoint's value in seconds, then the cycle will be terminated and an Excessive Purge Time alarm will be generated. This fault requires a lockout reset to resume purge operation.
171	FLA COMP#1	Full Load Amps for compressor #1. This is the amps at design suction and discharge pressures referenced in the MCS-Config RO screen. This value is used to calculate the high and the low amperage safety limits. Refer to Setpoints #75 and #76. For screw compressors: The amp draw when the compressor is fully loaded. This value is used to calculate the Full Load Amps Percentage (FLA %), which is used to control loading and unloading the slide valve. If 1 is set in the Time (SEC) column activates "Screw gap logic".
172	FLA COMP#2	Full Load Amps for compressor #2. Refer to Setpoint #171.
173	FLA COMP#3	Full Load Amps for compressor #3. Refer to Setpoint #171.
174	FLA COMP#4	Full Load Amps for compressor #4. Refer to Setpoint #171.
175	FLA COMP#5	Full Load Amps for compressor #5. Refer to Setpoint #171.
176	FLA COMP#6	Full Load Amps for compressor #6. Refer to Setpoint #171.

#	Name	Description
177	FLA COMP#7	Full Load Amps for compressor #7. Refer to Setpoint #171.
178	FLA COMP#8	Full Load Amps for compressor #8. Refer to Setpoint #171.
179	FLA COMP#9	Full Load Amps for compressor #9. Refer to Setpoint #171.
180	FLA COMP#10	Full Load Amps for compressor #10. Refer to Setpoint #171.
181	FLA COMP#11	Full Load Amps for compressor #11. Refer to Setpoint #171.
182	FLA COMP#12	Full Load Amps for compressor #12. Refer to Setpoint #171.
183	FLA COMP#13	Full Load Amps for compressor #13. Refer to Setpoint #171.
184	FLA COMP#14	Full Load Amps for compressor #14. Refer to Setpoint #171.
185	FLA COMP#15	Full Load Amps for compressor #15. Refer to Setpoint #171.
186	FLA COMP#16	Full Load Amps for compressor #16. Refer to Setpoint #171.
187	FLA COMP#17	Full Load Amps for compressor #17. Refer to Setpoint #171.
188	CMP SPEED OPTIMIZE DELAY	If active - Type should be set as "DELAY" – so the time in sec column is adjustable via MCS-Connect. Value contains the time delay before comp speed optimization is attempted (typically 300 to 900 seconds) Time in sec column contains the delay between optimization adjust to the vane & speed. (typically 3 to 4 seconds) (SEE SECTION 'CMP SPD OPTIMIZE IN THIS MANUAL)
189	B-FLA PUMP (Boiler/Pump Control)	The expended amp draw of the pump. If active this value is used to calculate the high and the low ampere safeties limits. Refer to set points 75 and 76.
190	B-FLA BOILER (Boiler/Pump Control)	The 'Value' is not used as this set point is set up to check the status of a digital input indicated in the Starting Boiler Fault cell. 'Time(sec)' field: contains the delay before the system will place a boiler stage in a failed state.
191	TEMP DIFF	This temperature differential is used to replace the hardcoded temperature differential values of several other Setpoints. If active, it is used with the following: <ul style="list-style-type: none"> ■ Discharge temperature ■ Low oil seal temperature ■ Low/high ambient cutoffs ■ Compressor discharge superheat If inactive, then hardcoded value of 5° F is used.
192	FRZ TEMP DIFF	If active, this value is added to Setpoint #102 "PUMP FREEZE PROTECTION" to determine if the leaving temperature is above the freeze protection zone.
193	CND HI/LO ZONE	The value in this Setpoint is the high and low zone for your target of Setpoint #50 "CND TRGT". If inactive then a default zone of 5 psi will be used, if metric .3 Bar.
194	CND 2ND ZONE	The value in this Setpoint is the 2nd high and low zone for your target of Setpoint #50 "CND TRGT". If inactive then a default zone of 20 psi will be used, if metric 1.4 Bar.
195	LOW VOLTAGE	If active and the voltage of any one of the voltage sensors is less than the value of this Setpoint for the time specified in the safety time cell, then a Low Voltage alarm will be generated and the unit will be locked out. Voltage sensors are specified in the General Information panel under the MAGNUM screen.
196	HI VOLTAGE	If active and the voltage of any one of the voltage sensors is greater than the value of this Setpoint for the time specified in the safety time cell, then a Hi Voltage alarm will be generated and the unit will be locked out. Voltage sensors are specified in the General Information panel under the MAGNUM screen.

#	Name	Description
197	COND LOW AMB	Standard condenser logic dictates that a newly started compressor will use its own discharge pressure as the control for the first five minutes. If this Setpoint is active and the ambient temperature sensor is reading less than the value of this Setpoint, then this compressor's discharge pressure will remain in control for the additional time in seconds as specified in the 'Time (sec)' field.
198	PROC PUMP FLT. (Only HVAC)	If process pump fault sensors are specified, the Magnum checks for process pump failure. The process pump fault sensor reading is ON (Digital) for the time specified in the safety time cell
199	MOP TARG PSI	If active, maximum operating pressure (MOP) control will be added to the EXV control logic. This value will be the MOP suction pressure target.
200	MOP PSI ZONE	Added to and subtracted from Setpoint #199 to develop the upper and lower limits of the MOP control zone.
201	LOW SI OFF	FEATURE NOT YET AVAILABLE If active, the Magnum checks for a Low SI Off sensor for each compressor. The sensor can be either an analog or digital input, and is specified in the Circuit SI screen. If the Low SI Off sensor reading is OFF (Digital) or falls below the value of this Setpoint (Analog) for the specified period of time, the circuit will be disabled. If a digital input, the circuit will be enabled once the sensor is ON. If an analog input, the circuit will be enabled once the sensor is greater than this value plus the value in the 'Time (sec)' field. 'Time (sec)' field: Differential value of this Setpoint which the analog input must be greater than to enable the compressor.
202	DELTA TEMP EVP (Only HVAC)	If active, the Magnum will check the temperature differential before additional capacity is enabled. If the difference between entering and leaving temperature is less than the value of this setpoint for the ½ amount of time in the 'Time (sec)' field, then additional capacity will be allowed else no additional steps will be allowed on. If the difference between entering and leaving temperature is greater than the value of this Setpoint for the amount of time in the 'Time (sec)' field, then a high delta evaporator temperature alarm will be generated.
	HI SI OFF (Only CENT)	If active, the Magnum checks for a High SI Off sensor for each compressor. The sensor can be either an analog or digital input, and is specified in the Circuit SI screen. If the High SI Off sensor reading is ON (Digital) or rises above the value of this Setpoint (Analog) for the specified period of time, the circuit will be disabled. If a digital input, the circuit will be enabled once the sensor is OFF. If an analog input, the circuit will be enabled once the sensor is less than this value minus the value in the 'Time (sec)' field. 'Time (sec)' field: Differential value of this Setpoint which the analog input must be less than to enable the compressor.
203	HiSuctSheat	If active, the Magnum will check for high suction superheat. If the suction superheat is greater than the value of this setpoint for the specified period of time, an alarm will be generated and a safety trip occurs.
204	SurgeHldDlay	The time in minutes to remain in a surge increase hold state after the occurrence of a surge. The surge counter will be reset with each new surge. When the surge counter exceeds this value the compressor state will move to CMP IS HOLDING state.
205	SurgeLoadAdj	The adjustment to increase compressor speed when surging is detected.
206	COND HI AMB	If active, standard condenser control on compressor startup logic will be bypassed when there is a high ambient temperature. If the condenser type is common and the ambient temperature is above the value of this Setpoint, then the compressor with the highest discharge pressure will have control of the condenser.
207	UNBAL VOLTS	If active, the average of the voltage sensors is calculated. If the average is greater than the value of this setpoint for the time in safety time, an alarm is generated and the unit is locked out. The system can be restart based on the time in the Lockout Delay cell.
208	NOT USED	

#	Name	Description
209	COMP SURGING	The number of surges allowed before a safety trip occurs. Surges can either come in the form of sudden amperage or lift changes. The amp draw rate of change difference for the compressor is recorded over a period of time, not to exceed 60 seconds. When change exceeds the value in Setpoint #210 "AMP SurgeROC", it is counted as a surge. This rate of change difference can be either a positive or negative value. The lift pressure rate of change is the difference between discharge and suction pressure for the compressor recorded over a period of time, not to exceed 60 seconds. When change exceeds the value in Setpoint #211 "LiftSurgeROC", it is counted as a surge. This rate of change difference can be either a positive or negative value.
210	AMP SurgeROC	Refer to Setpoint #209 "COMP SURGING".
211	LiftSurgeROC	Refer to Setpoint #209 "COMP SURGING".
212	SurgingCount	This Setpoint is used to take preventive action to avoid a safety trip from excess surges. If the number surges exceed this value within the time in seconds of Setpoint #213 "Surging- Time", then the compressor speed will increase and the valve will close and the compressor state will change to UNIT LOADING-VFD.
213	SurgingTime	Refer to Setpoint #212 "SurgingCount".
214	NO OIL FLOW	If active and there is an Oil Flow sensor specified in the 'Oil Flow Switch' cell of the Circuit SI screen, then the Magnum will test for oil flow. If the No Oil Flow sensor reading is OFF (Digital) or falls below the value of this Setpoint (Analog) for the specified period of time, then a safety trip occurs.
215	COMP SPD FLT	If active and there is an Compressor Speed Fault sensor specified in the 'Compressor speed fault' cell of the Circuit Base screen, then the Magnum will test for Compressor Speed Fault whether the compressor is running or not. The fault sensor can be either an analog or digital input. If the fault sensor reading is ON (Digital) or falls below the value of this Setpoint (Analog) for the specified period of time, then a safety trip occurs. 'SEC to Ignore Safety' field: delay before adjusting the EXV on TurboCor compressors on a common suction group, allowing the system to stabilize before making an adjustment.
216	CLLC LEVEL TRG	The 'Value' is the target that is to be maintained of the condenser liquid level. The 'Time (sec)' contains the dead band of the target. For example if the value is 60.0 (target) and the 'Time (sec)' field is 5 (dead band) the control zone for the condenser liquid level is between 55.0 and 65.0.
217	CLLC VALVE TRG	The 'Value' is the target or minimum opening of the CLLC control valve. The 'Time (sec)' contains the normal delay between making valve adjustments. This time is in seconds. The 'Sec. to Ignore Safety' contains the delay between making valve adjustments when the CLLC is in a startup mode or the chilled water is not within its control zone, this is an unstable condition. The 'Window to extend Safety Time(sec)' contains the maximum valve adjustment value. This value has an assumed decimal place; that is a value of 50 will allow a maximum adjustment of 5.0. The actual adjustment will be calculated based upon the valve setting and its desired position. This set point is only used if the AO TYPE of CLLC valve has been selected.
218	CLLC MAX ROC	The 'Value' contains the rate of change that will determine if the condenser liquid level rate of change is moving fast enough.
	OIL REC VENT CYCLE #1	Time on for device #1 vent cycle.
219	OIL REC VENT CYCLE #2	Time on for device #2 vent cycle.
220	OIL REC VENT CYCLE #3	Time on for device #3 vent cycle.
221	OIL REC VENT CYCLE #4	Time on for device #4 vent cycle.

#	Name	Description
222	OIL REC OIL POT CYCLE	Time on for oil pot cycle, common.
223	OIL REC OIL CHARGE CYCLE	Time on for oil charge cycle.
224	OIL REC REPEAT CYCLE	Time delay before repeating cycles.
225	NOT USED	
226	REGENCap Time	Value of this setpoint is the maximum time it takes the carbon capacity to go from 100% to 0 %
227	CLLC MAX ROC	Condenser Liquid Level Control max ROC both plus and minus ROC. If opening the CLLC valve and the slope is less than this value then the state will be holding else if will be opening. If closing the CLLC valve and the slope is greater than this value then the state will be holding else if will be closing.
	RegenTermTmp	If setpoint #227 is setup as an "ALARM" type, then this event is logged in the MCS-Magnum alarm history. This is an event notice only. If setpoint #227 is not setup as an "ALARM" type, the event is not logged in the MCS-Magnum alarm history.
228	RegTermTime	If setpoint #228 is setup as an "ALARM" type, then these event are logged in the MCS-Magnum alarm history. This is an event notice only. If setpoint #228 is not setup as an "ALARM" type, the event is not logged in the MCS-Magnum alarm history.
229	CHK VALVE FLT (Only TurboCor compressor type selection)	NOTE: Discharge Pressure Sensor needs to be installed between compressor and check valve. VALUE: If the psi differential goes above this value while the compressor is off safety trip the unit (all compressors). Time (SEC): The time to wait before the safety trip. SEC to Ignore Safety: The time the compressor has to be off before checking the psi differential.
	HiRegenTemp	If setpoint #229 is active and carbon tank temperature reaches or excess the setpoint's value, an alarm is generated, and the purge unit is locked out and all purge relays locked off.
230	Not Used	
231	RegNoTmpRise	If setpoint #231 is active and carbon tank temperature does increase more than the setpoint's value with the time defined by the setpoint time field, an event alarm is generated. This is an event notice only.
232	RegNoTmpDecr	If setpoint #232 is active and carbon tank temperature does decrease more than the setpoint's value with the time defined by the setpoint time field, an event alarm is generated. This is an event notice only.
233	RegenChlOn%	When compressor is running and no purge exhausting has occurred for 60 minutes (setpoint #160) and the capacity of the carbon tank is less than or equal to this value of the capacity (setpoint #226) perform a regeneration cycle.
234	RegenChlOff%	When compressor is off and no purge exhausting has occurred for 60 minutes (setpoint #160) and the carbon tank capacity is less than or equal to this value of the capacity (setpoint #226) perform a regeneration cycle.
235-237	NOT USED	
238	Heat Target	Heat target. This value is used as the base to develop the control zone when the unit is in a heating mode. Refer to setpoints #239 and #240. The control target is used with the heat zone and rate of change of the controlling sensor to determine required action for the Magnum. When heating is selected (heat pump or electric heat) this will be the target temperature for heat mode. A heat indicator input is required to switch unit into heating.

#	Name	Description
239	Heat Zone +	Added to the Heat Target to create the upper limit of the control zone
240	Heat Zone -	Subtracted from the Heat Target to create the lower limit of the control zone.
241	Amp Imbalance	This test averages the 3 amp readings then finds the amp reading which is the furthest away from the average and checks to see if this amp reading deviation percentage is more than the unbalance percentage setpoint value.
242-245	NOT USED	
246	RegenCoolTmp	If setpoint #246 is setup as "ALARM" type, then this event is logged in the MCS-Magnum alarm history. This is an event notice only. If setpoint #246 is not setup as an "ALARM" type, the event is not logged in the MCS-Magnum alarm history.
247	RegenCoolTim	If setpoint #247 is setup as an "ALARM" type, then this event is logged in the MCS-Magnum alarm history. This is an event notice only. If setpoint #247 is not setup as an "ALARM" type, the event is not logged in the MCS-Magnum alarm history.
248-255	NOT USED	

31.3. Revision Page

Date	Author	Description of Changes
12-15-15	DEW	Setup manual from Magnum HVAC Manual
1-28-16	DEW	Changes made to chapters
2-12-16	DEW	Added updated Condenser section to this manual, updated TOB
10-03-16	DEW	Update Drawings
02-03-17	DEW	Add Modbus Fault Sensors to manual
02-06-17	DEW	Add Chiller Pump and Motor Amps from Bret
05-15-17	DEW	Make changes to BMS control states
06-29-17	DEW	Update setpoints to match HVAC update
08-08-17	DEW	Update setpoint #41 and 'Lube Delay' pg 39
06-04-18	DEW	Add new Condenser Diff PSI (Disc-Suct)
06-29-18	DEW	Change Setpoint 188
02-22-19	DEW	Change Setpoint 241
08-12-19	DEW	Update section 15 purge
08-15-19	DEW	Add Regen Carbon section
03-19-2020	DEW	Add address settings for MCS-IO expansion boards
04-8-2020	DEW	Add Connect Screens to Chapter 15, make corrections as per Dan C
05-27-2020	DEW	Add Trane Carbon Probe converting to MCS Carbon Temp Probe
06-16-2020	DEW	Modify setpoint 73 and Part Wind and Star Delta Starters section
06-19-2020	DEW	Merge EXV SSH, SSH2 and PID to this manual, change ver 2.3
10-12-2020	DEW	Add new PID Setpoints to manual and to the setpoint section
10-13-2020	DEW	Add surge control logic for surge lift from Jeff, move surge writeups to chap 18



Providing HVAC/R Control Solutions Worldwide

5580 Enterprise Pkwy. Fort Myers, FL 33905

Office: (239) 694-0089

Fax: (239) 694-0031

www.mcsccontrols.com